

EXPLODED DRAWING A

Model No. PFTL40916.2 R0218A

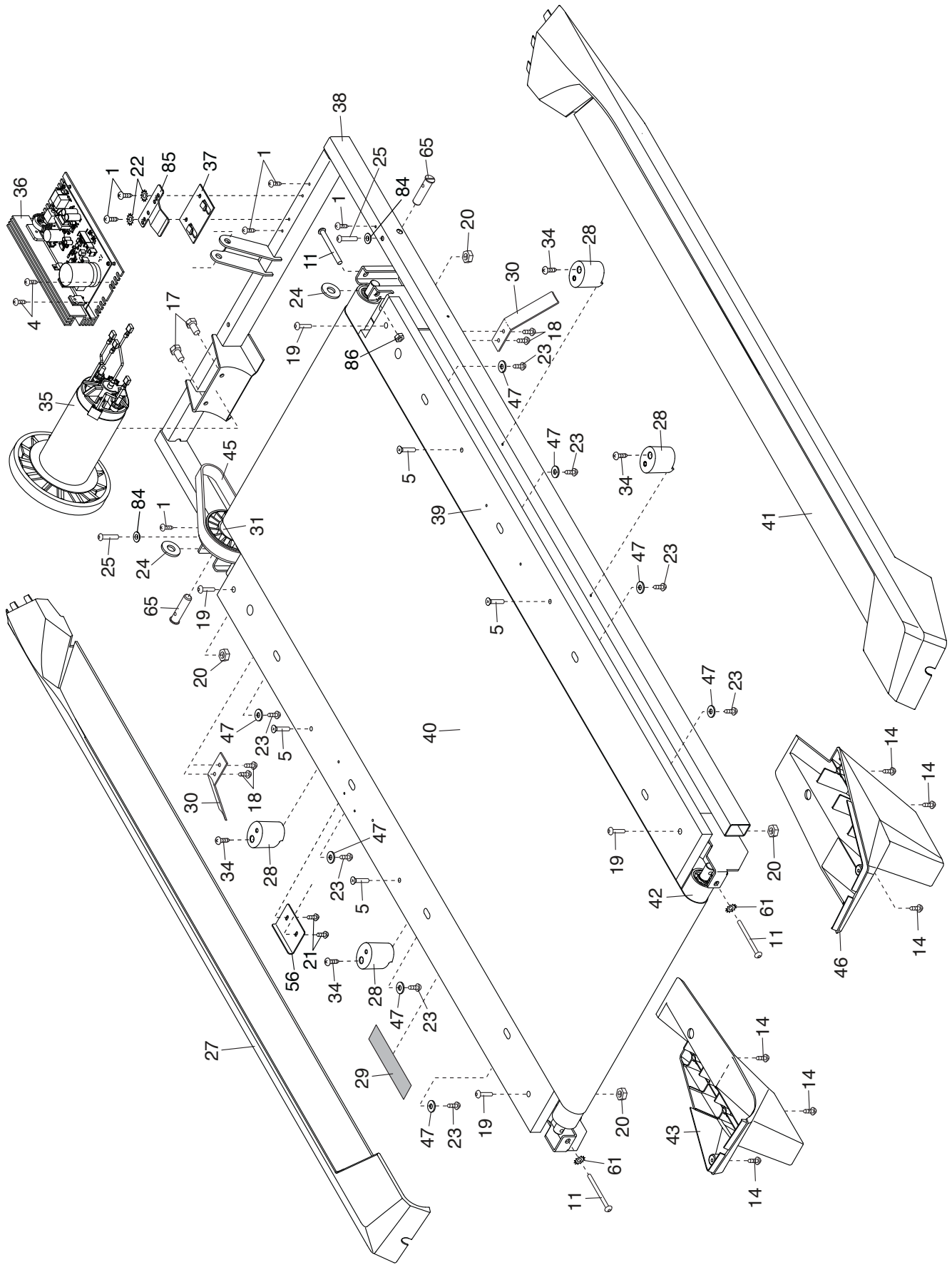

EXPLODED DRAWING B

Model No. PFTL40916.2 R0218A

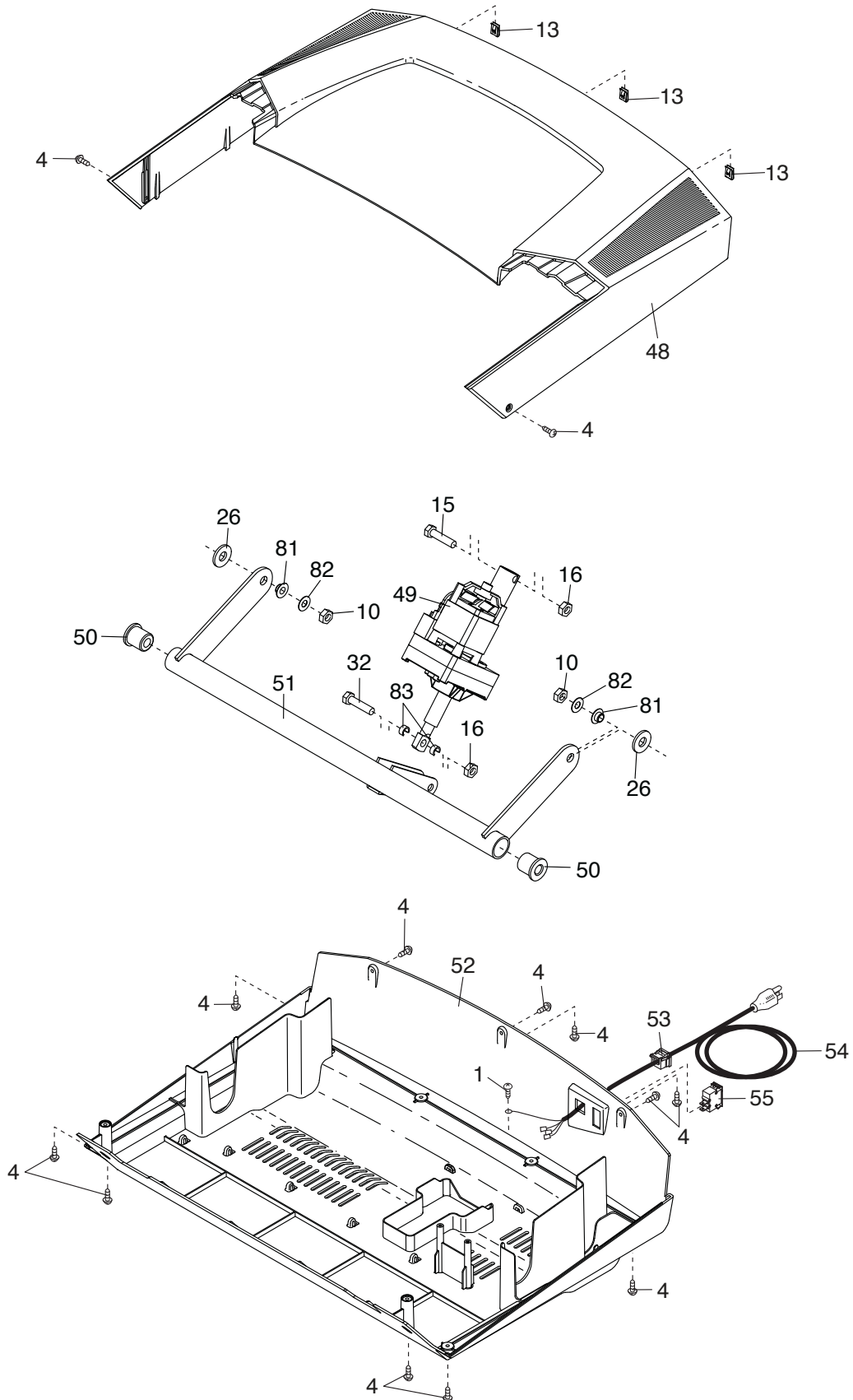

EXPLODED DRAWING C

Model No. PFTL40916.2 R0218A

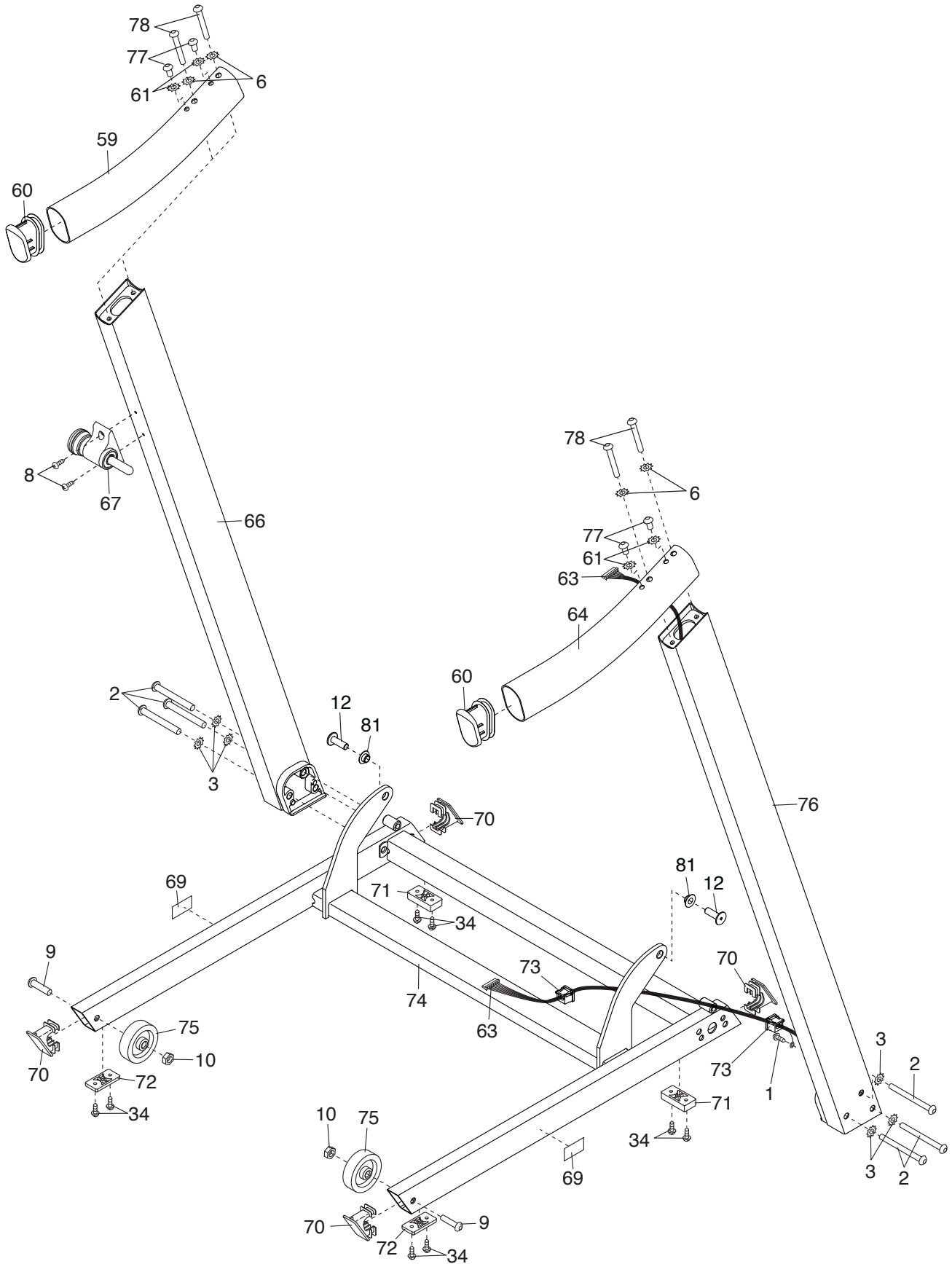

EXPLODED DRAWING D

Model No. PFTL40916.2 R0218A

