

EXPLODED DRAWING A

Model No. PFTL40917.3 R1117A

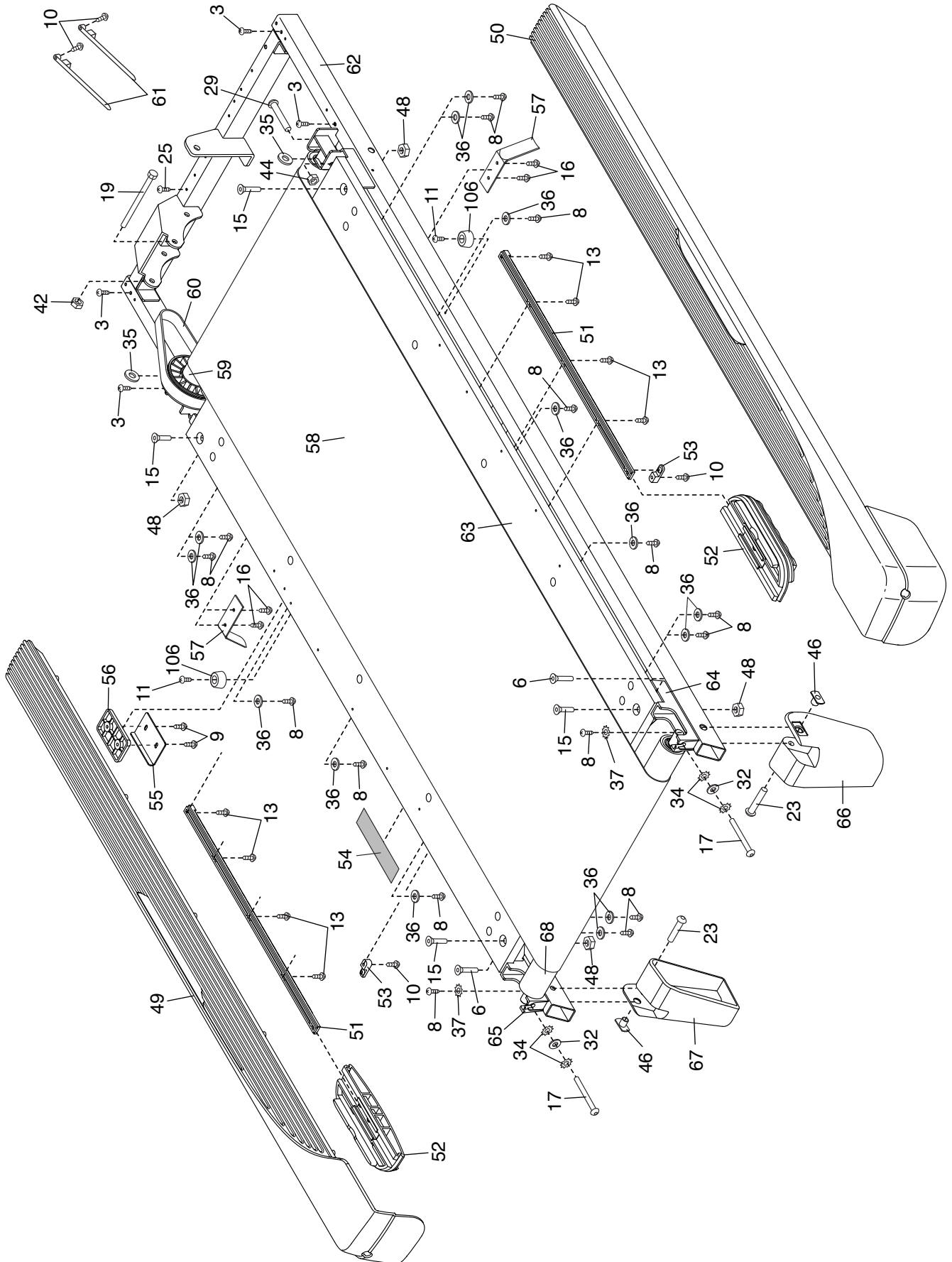

EXPLODED DRAWING B

Model No. PFTL40917.3 R1117A

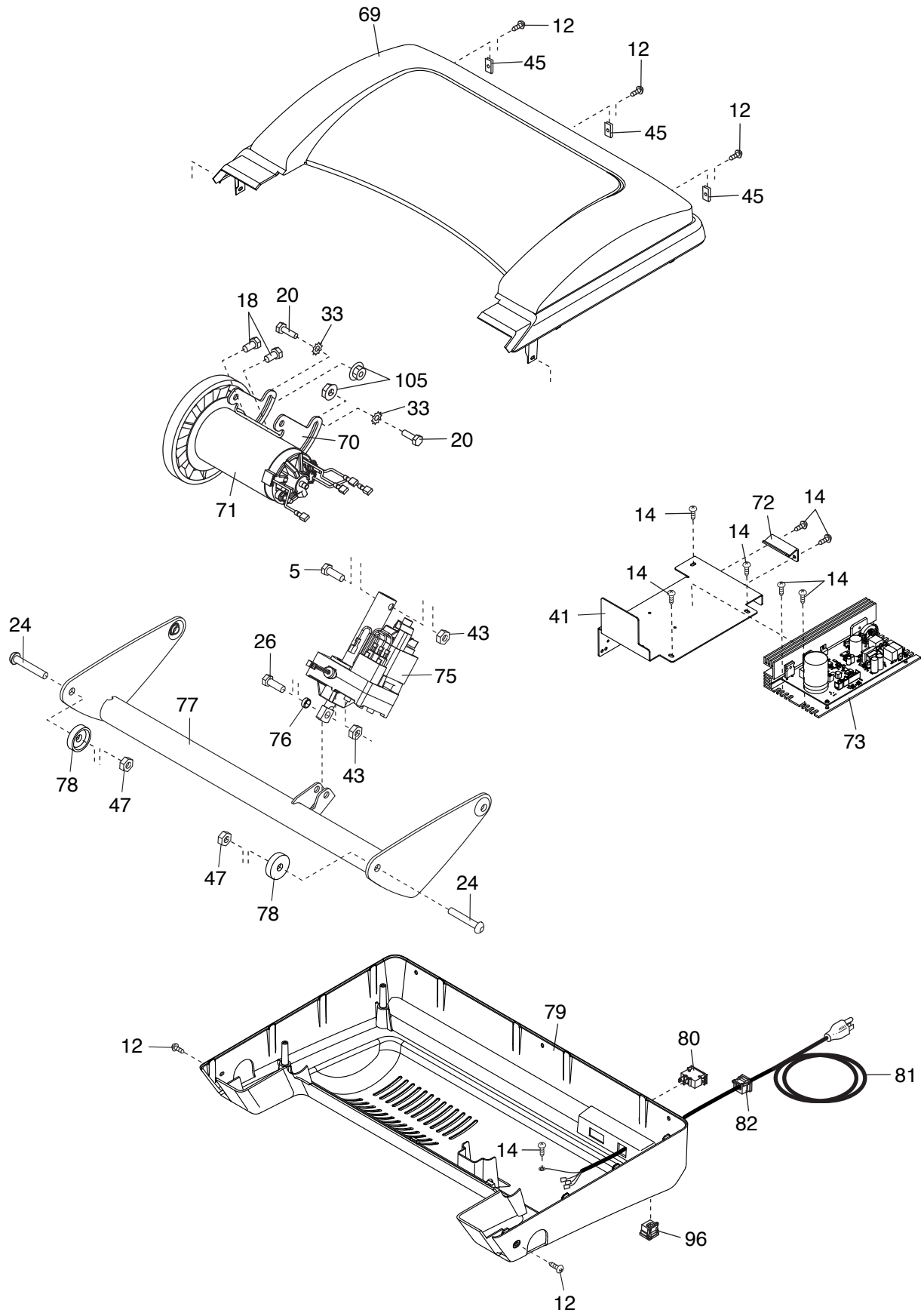

EXPLODED DRAWING C

Model No. PFTL40917.3 R1117A

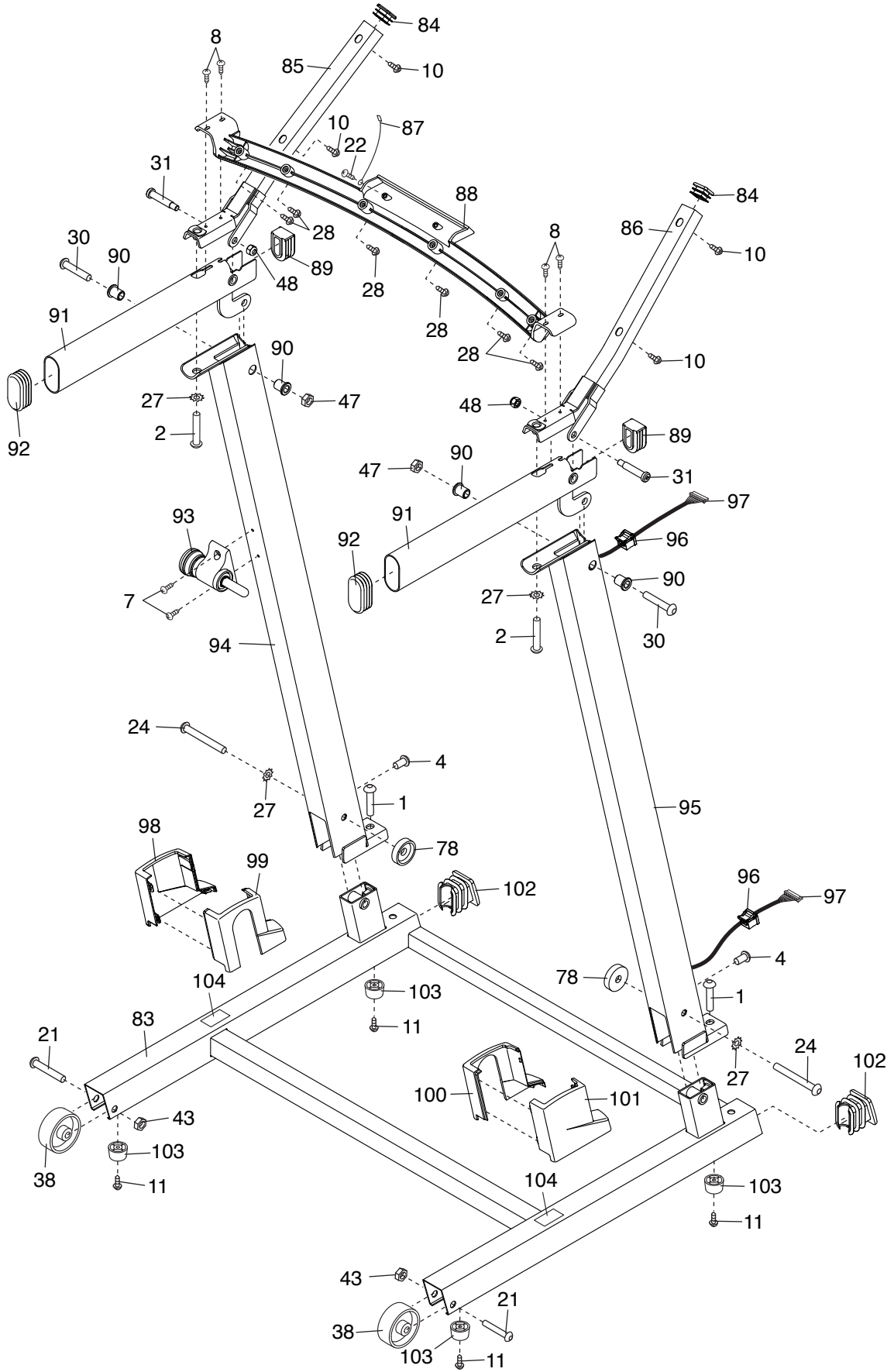

EXPLODED DRAWING D

Model No. PFTL40917.3 R1117A

