

EXPLODED DRAWING A

Model No. PFTL40917.6 R0919B

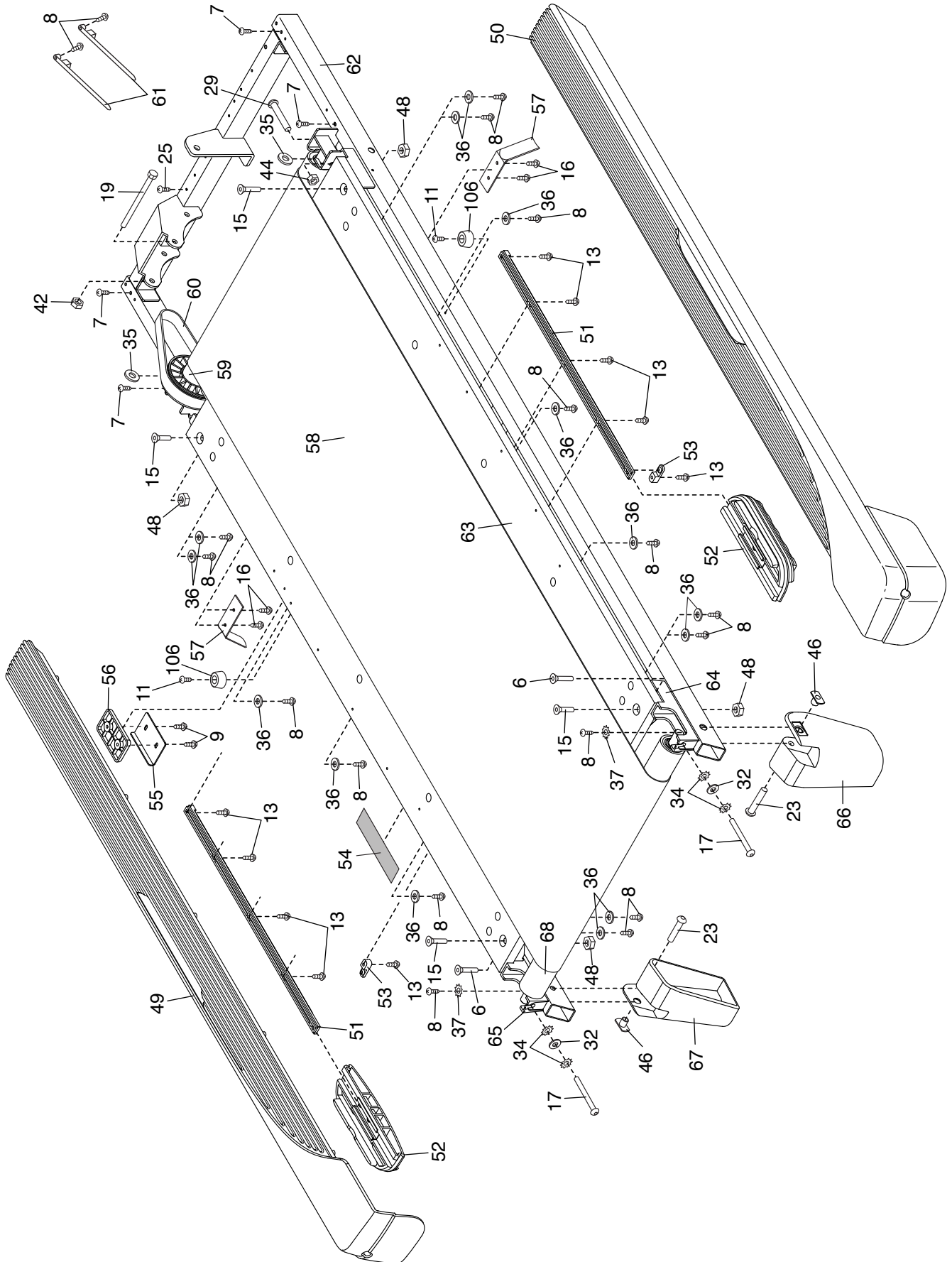

EXPLODED DRAWING B

Model No. PFTL40917.6 R0919B

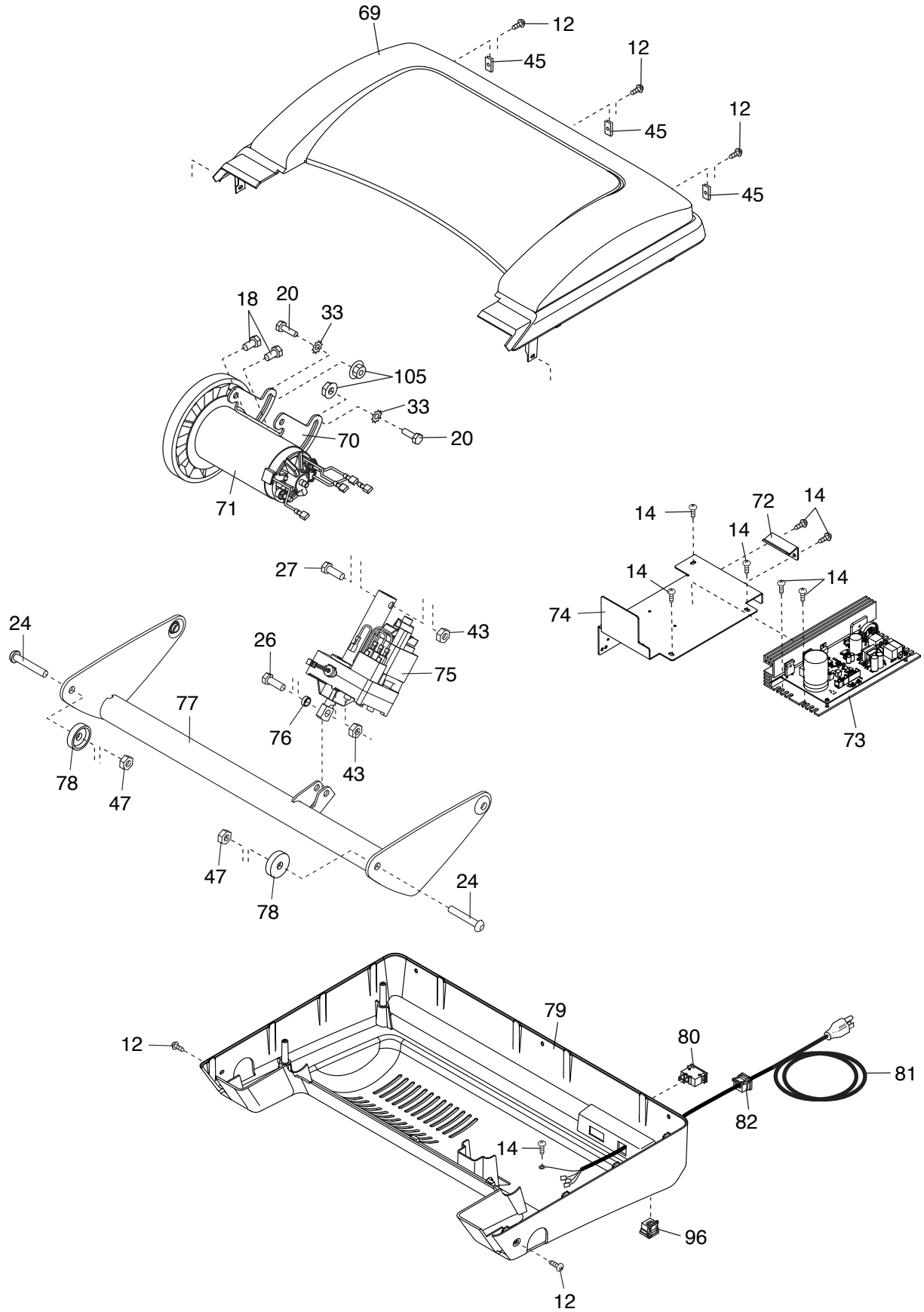

EXPLODED DRAWING C

Model No. PFTL40917.6 R0919B

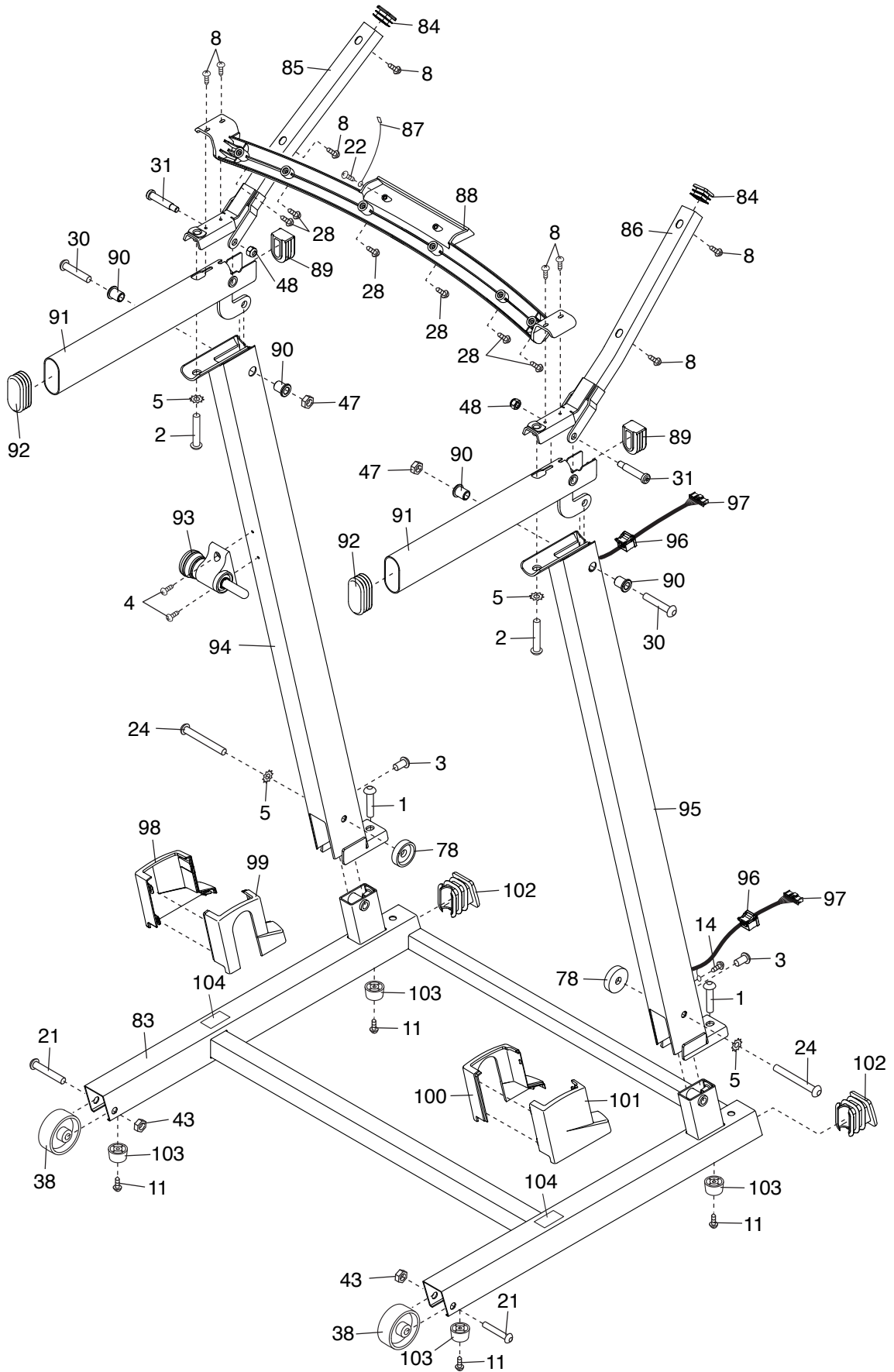

EXPLODED DRAWING D

Model No. PFTL40917.6 R0919B

