

EXPLODED DRAWING A—Model No. PFTL49508.0

R0808A

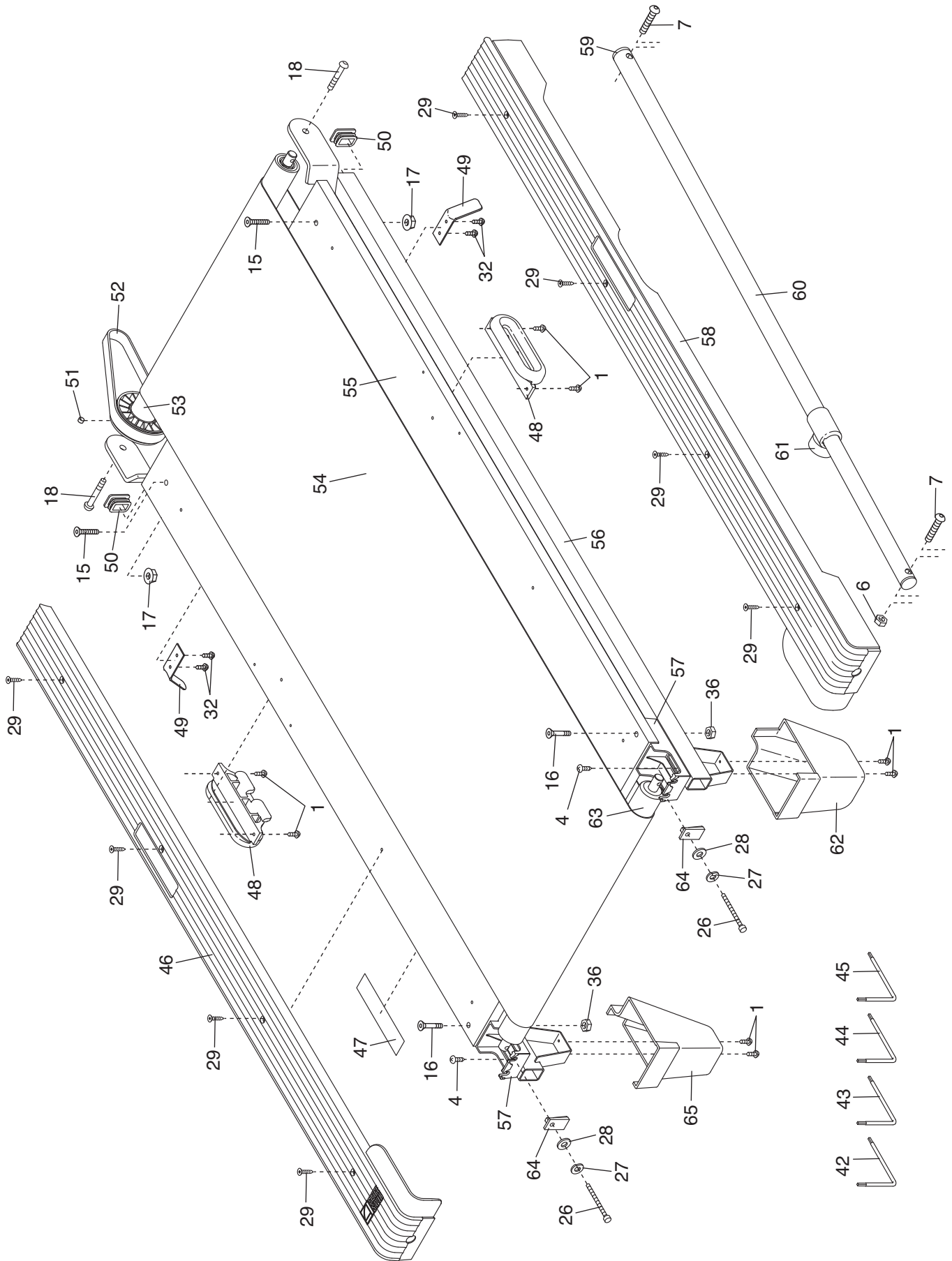

EXPLODED DRAWING B—Model No. PFTL49508.0

R0808A

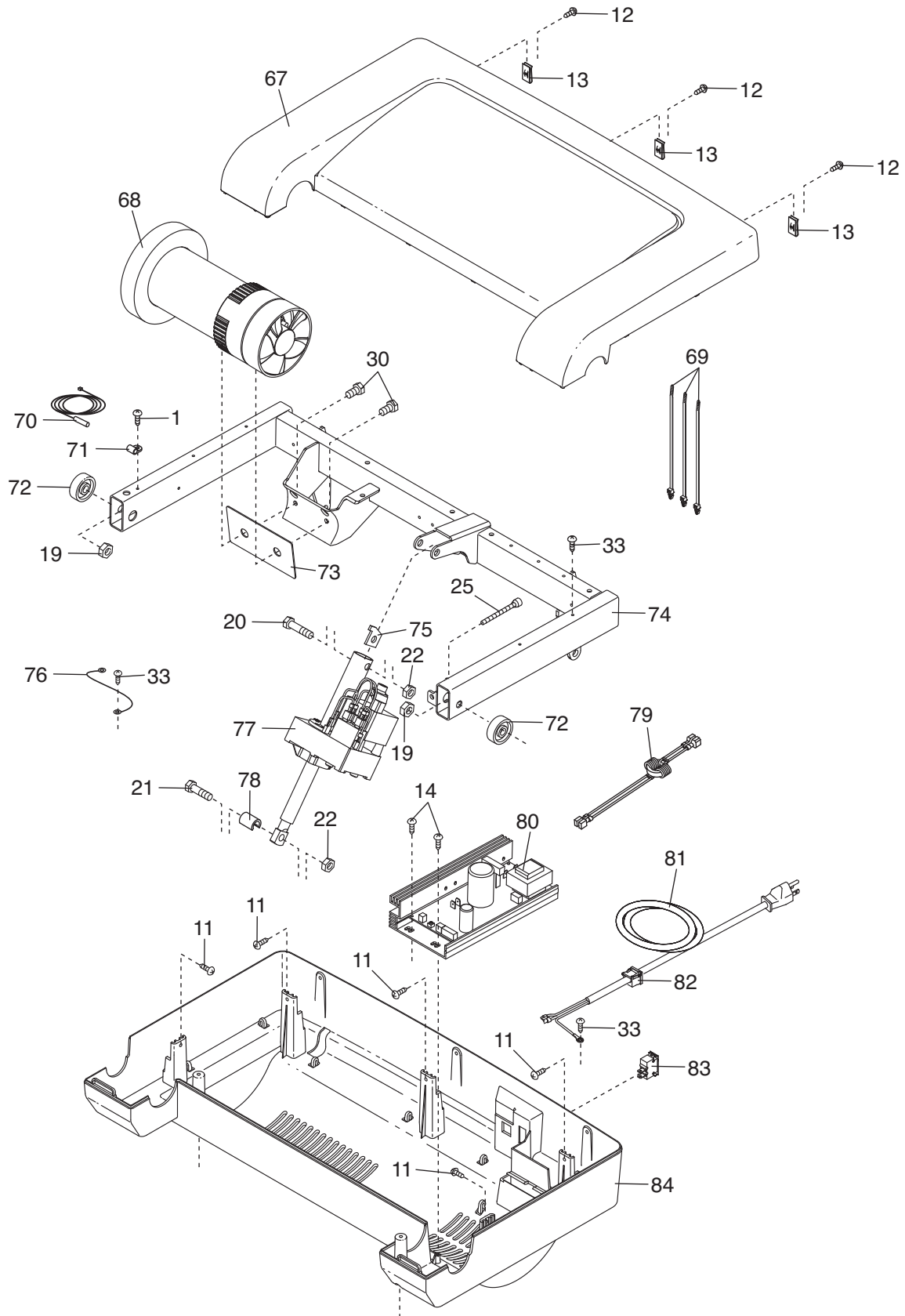

EXPLODED DRAWING C—Model No. PFTL49508.0

R0808A

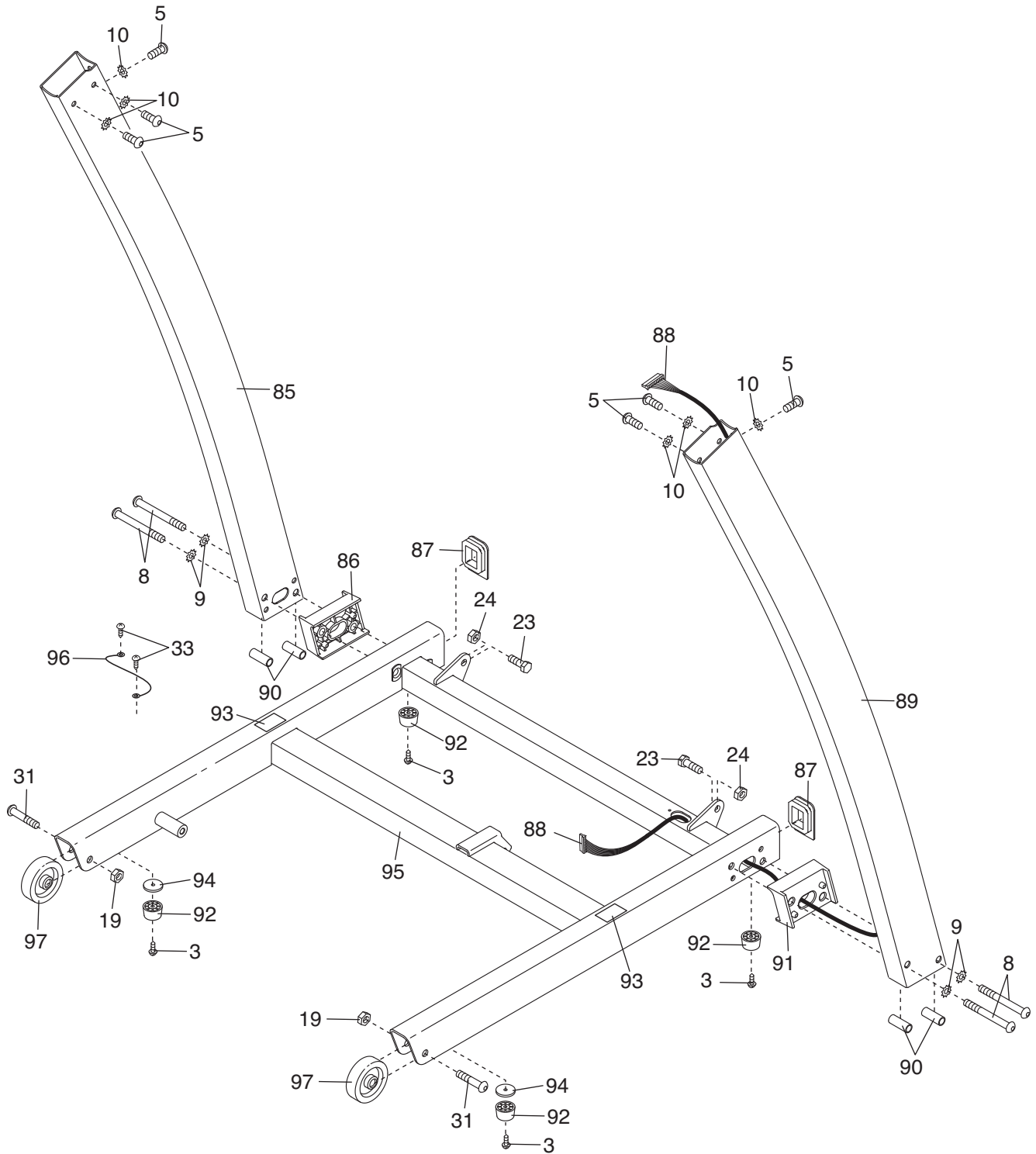

EXPLODED DRAWING D—Model No. PFTL49508.0

R0808A

