

# EXPLODED DRAWING A—Model No. PFTL49508.1

R1208A

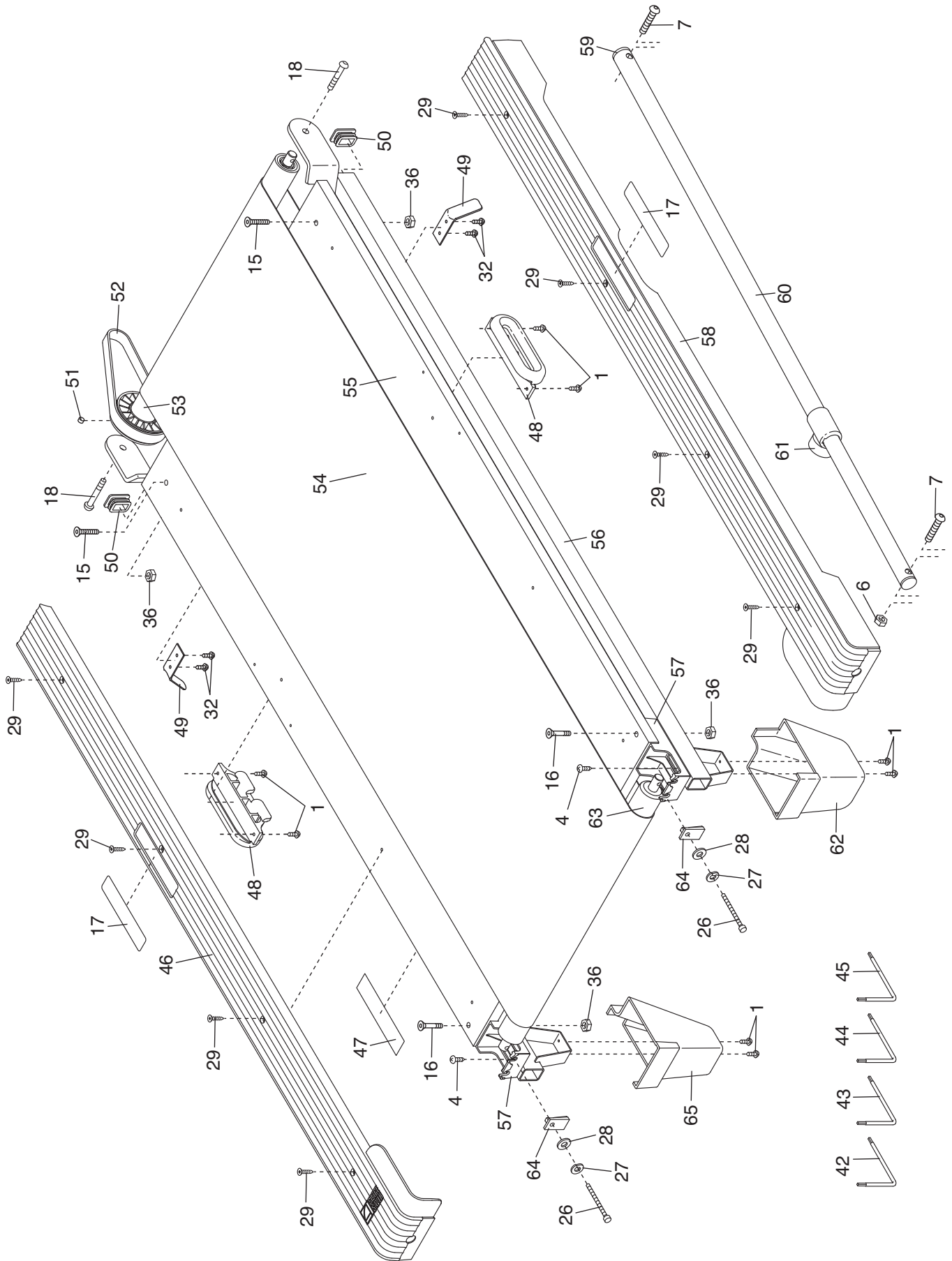

# EXPLODED DRAWING B—Model No. PFTL49508.1

R1208A

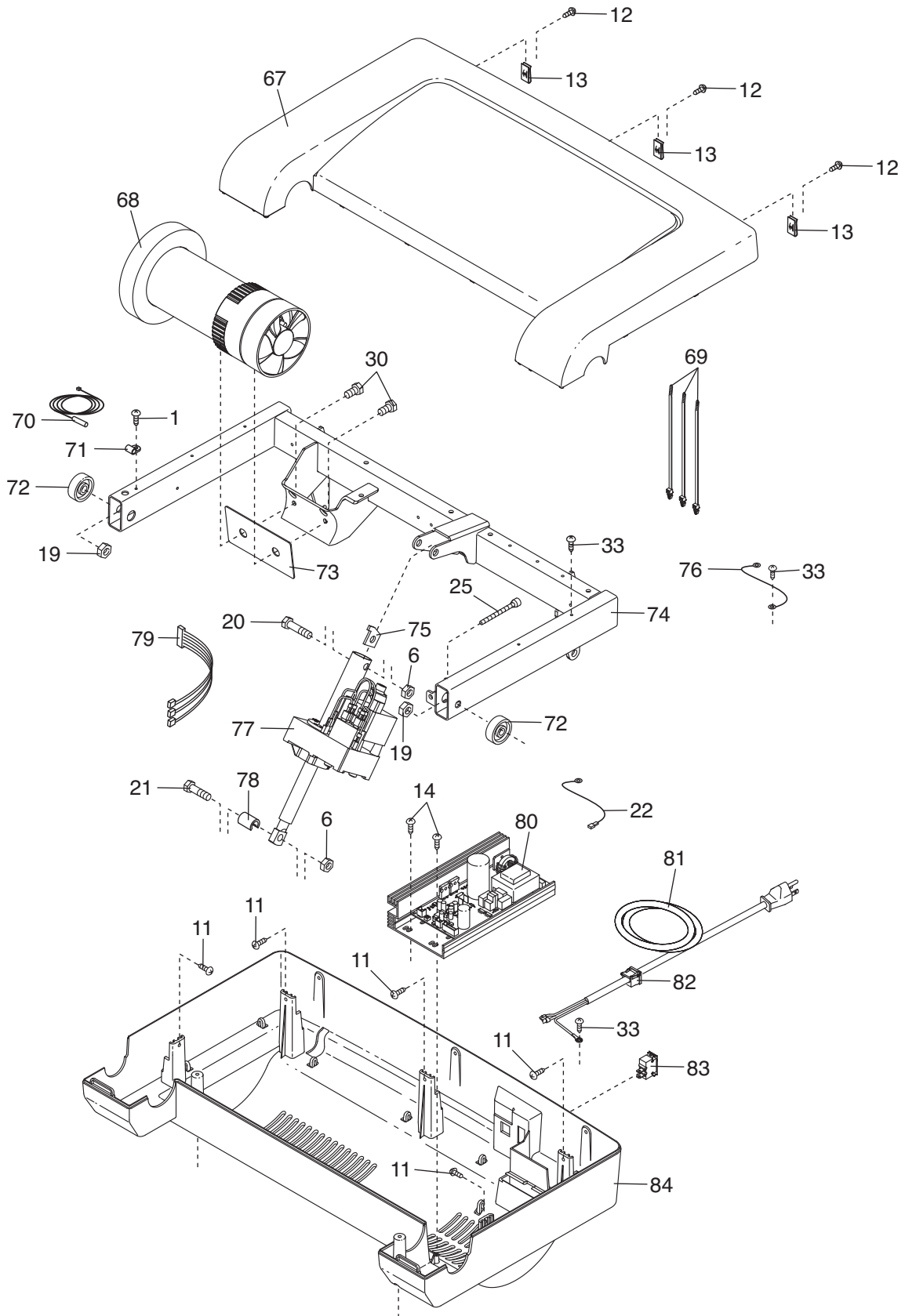

# EXPLODED DRAWING C—Model No. PFTL49508.1

R1208A

