

# EXPLODED DRAWING A—Model No. PFTL49609.0

R0310A

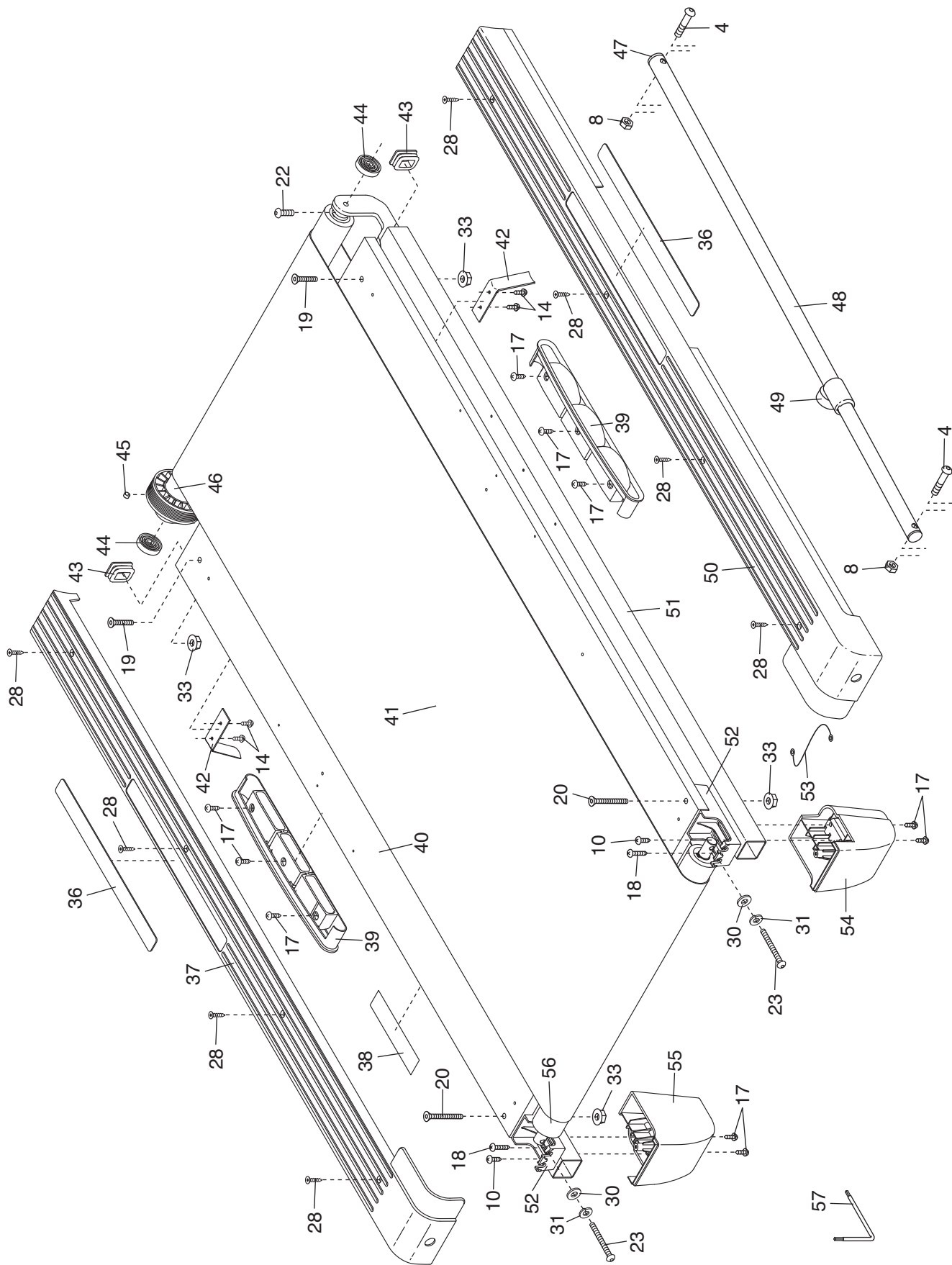

# EXPLODED DRAWING B—Model No. PFTL49609.0

R0310A

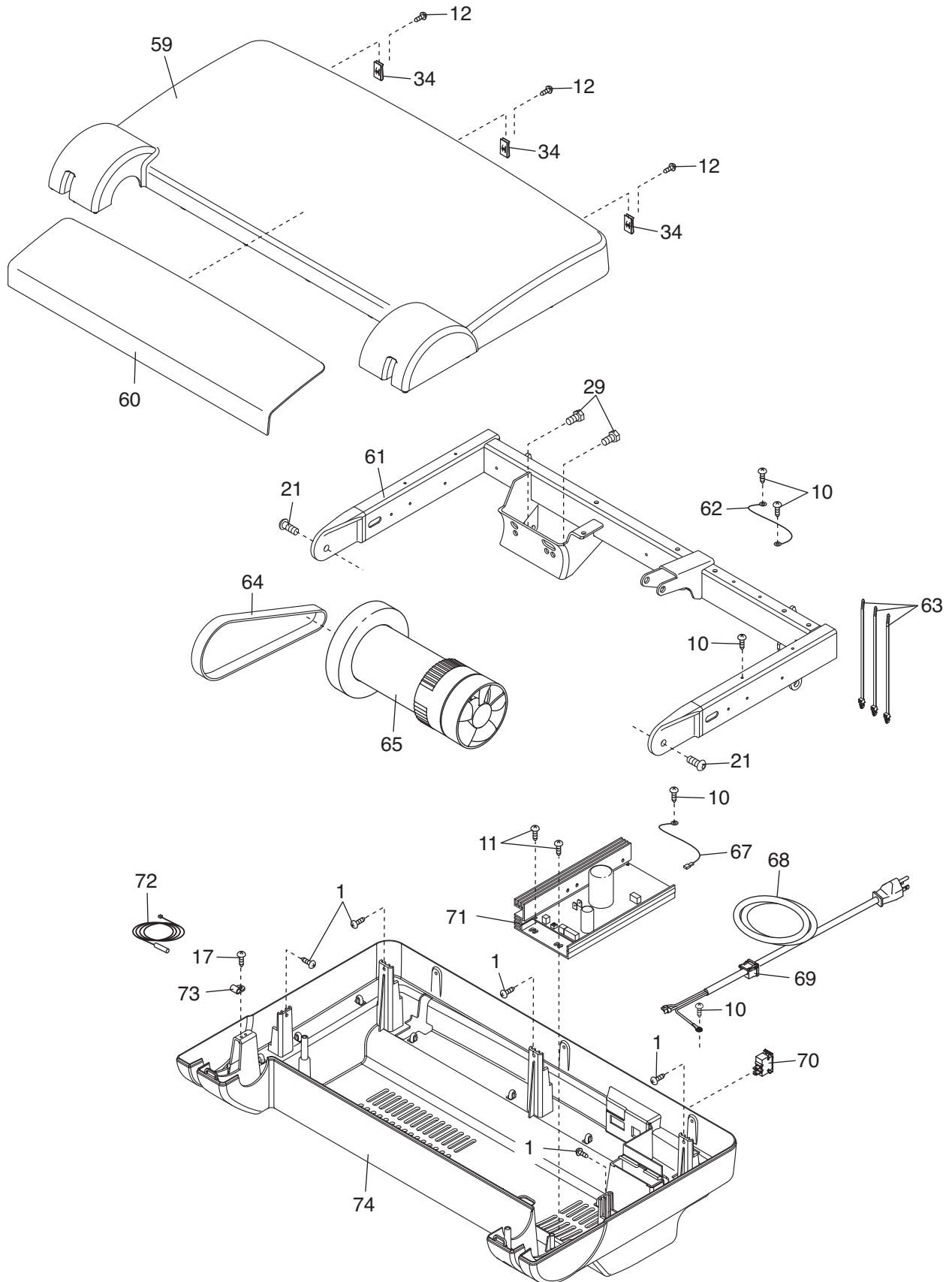

# EXPLODED DRAWING C—Model No. PFTL49609.0

R0310A

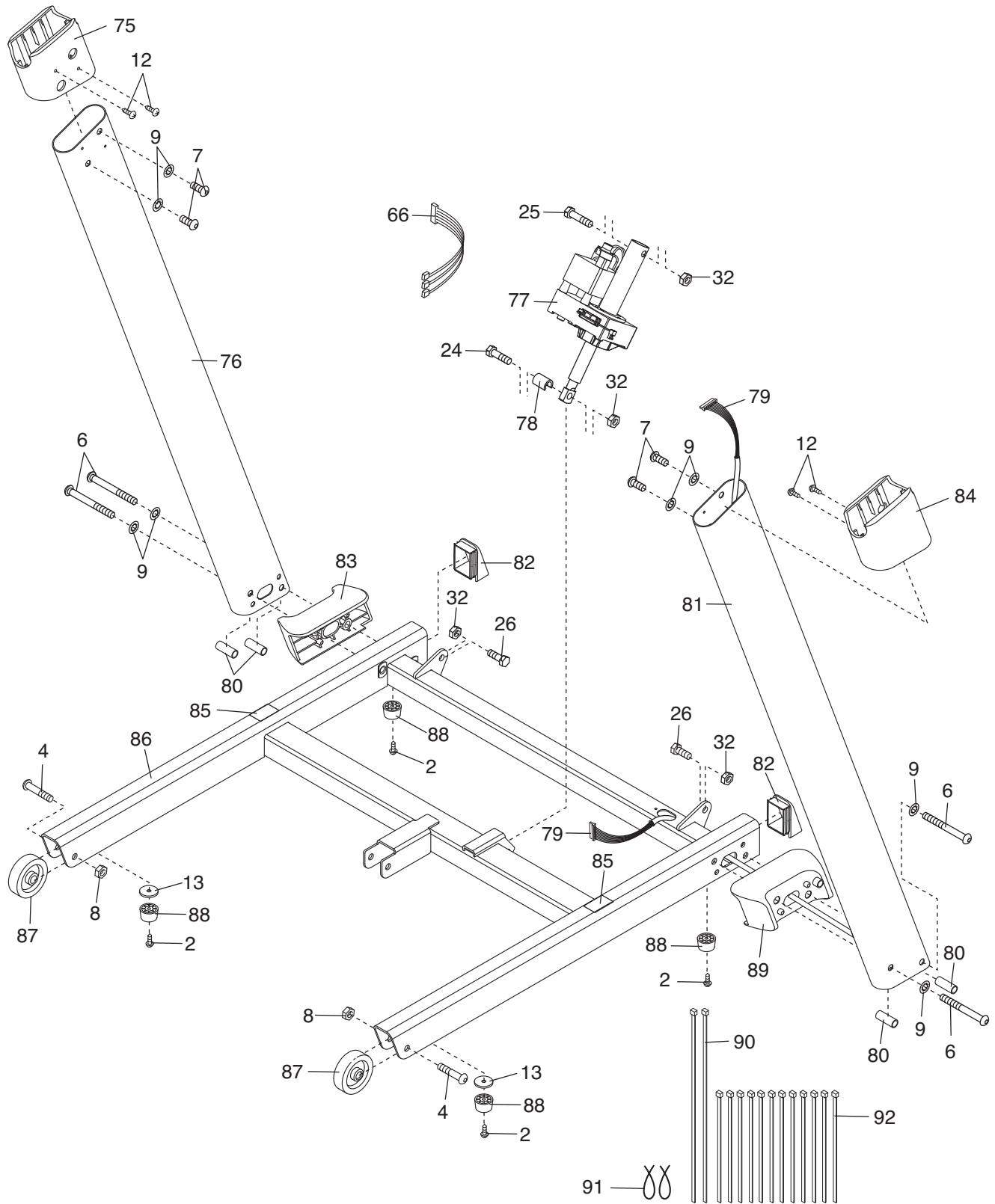

# EXPLODED DRAWING D—Model No. PFTL49609.0

R0310A

