

# EXPLODED DRAWING A—Model No. PFTL49610.0

R0710A

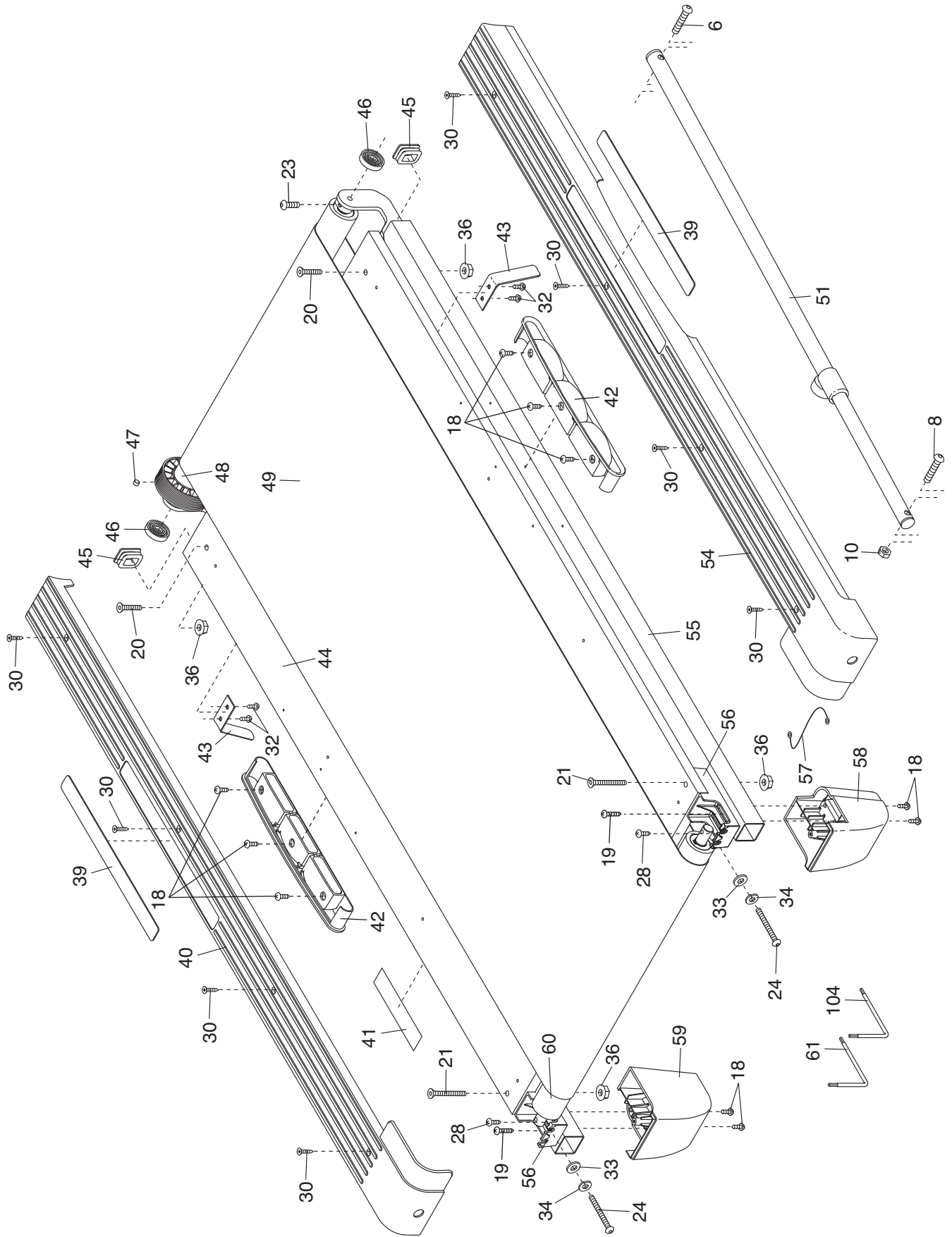

# EXPLODED DRAWING B—Model No. PFTL49610.0

R0710A

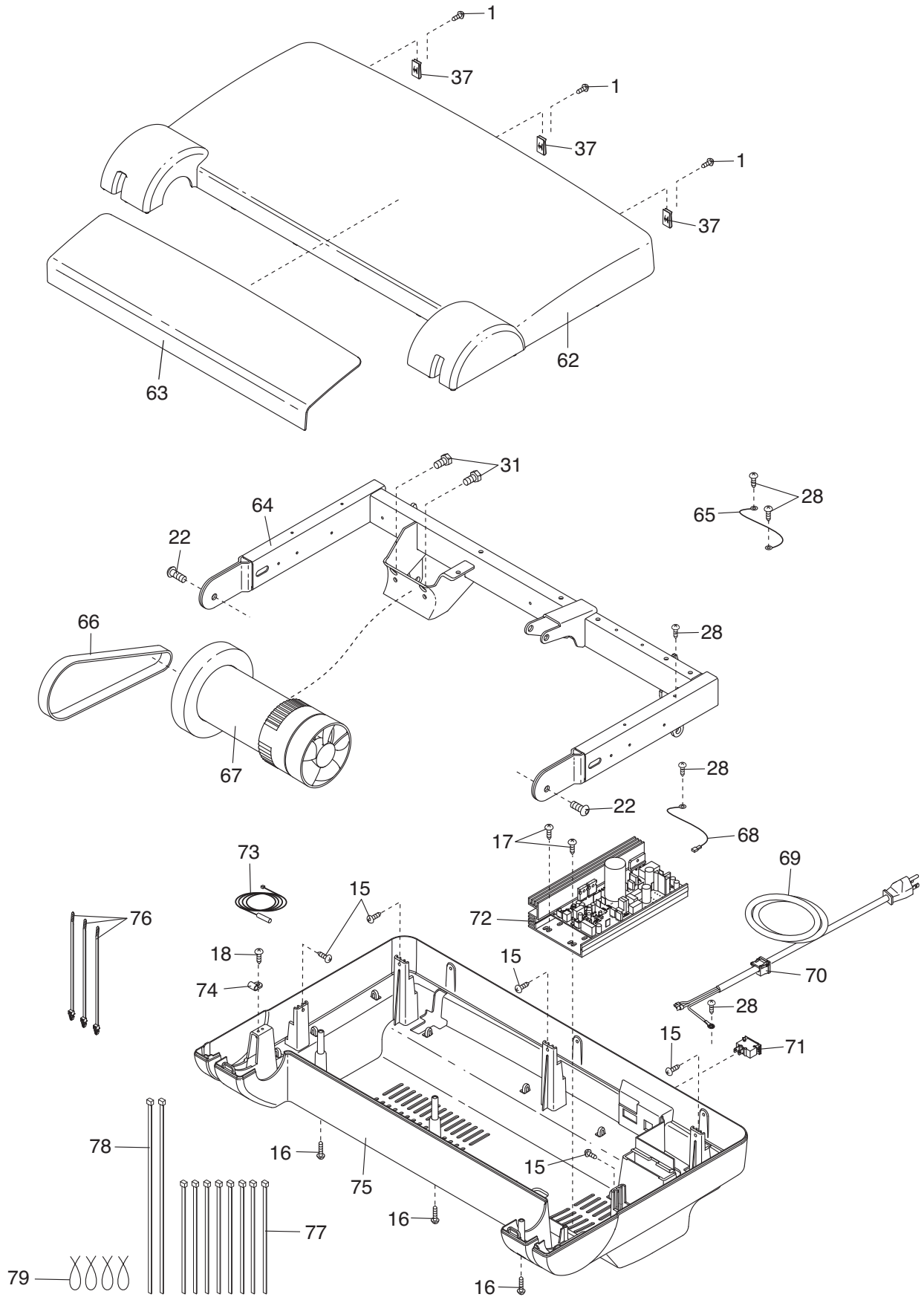

# EXPLODED DRAWING C—Model No. PFTL49610.0

R0710A

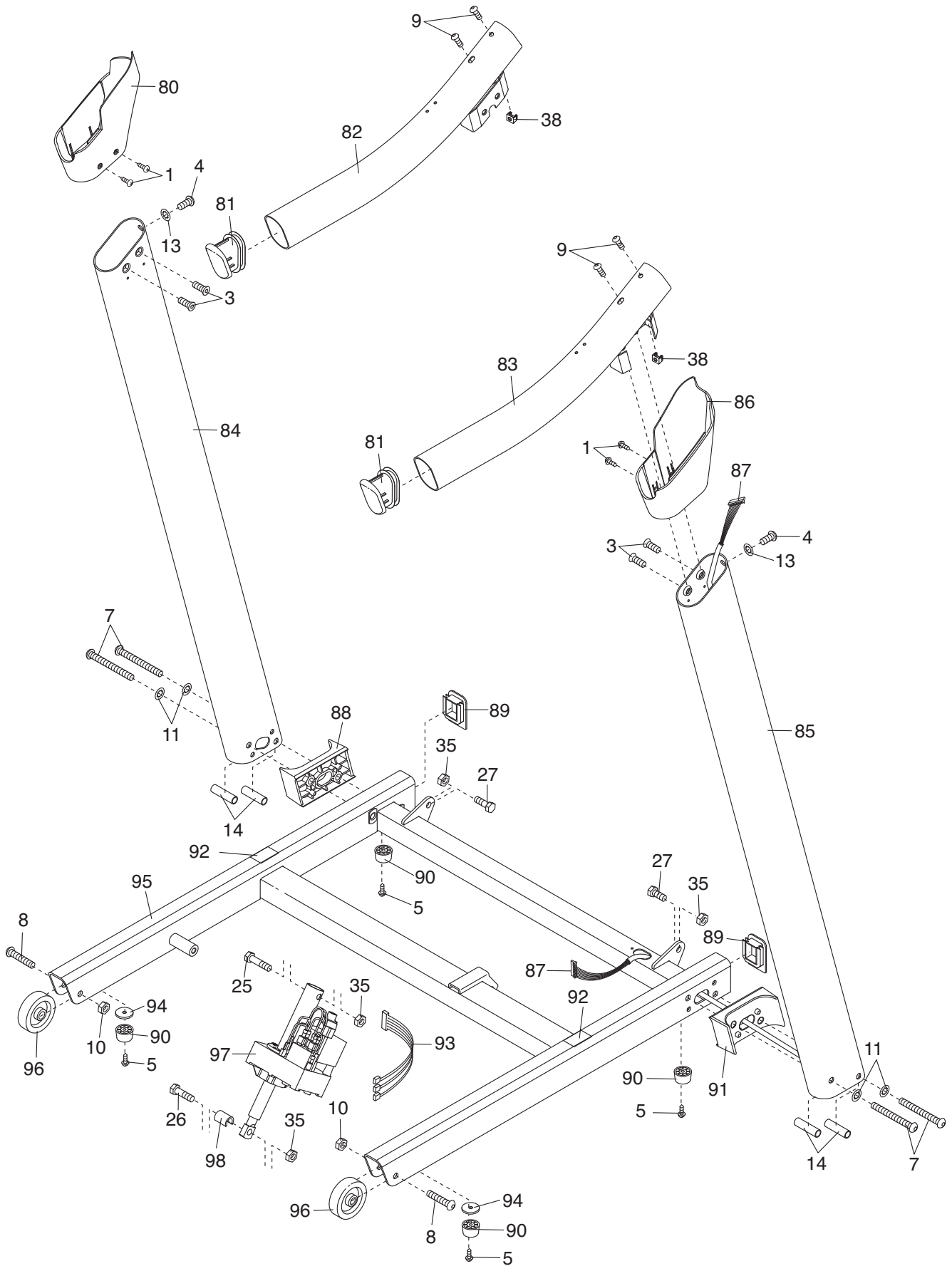

# EXPLODED DRAWING D—Model No. PFTL49610.0

R0710A

