

EXPLODED DRAWING A

Model No. PFTL49611.1 R0611A

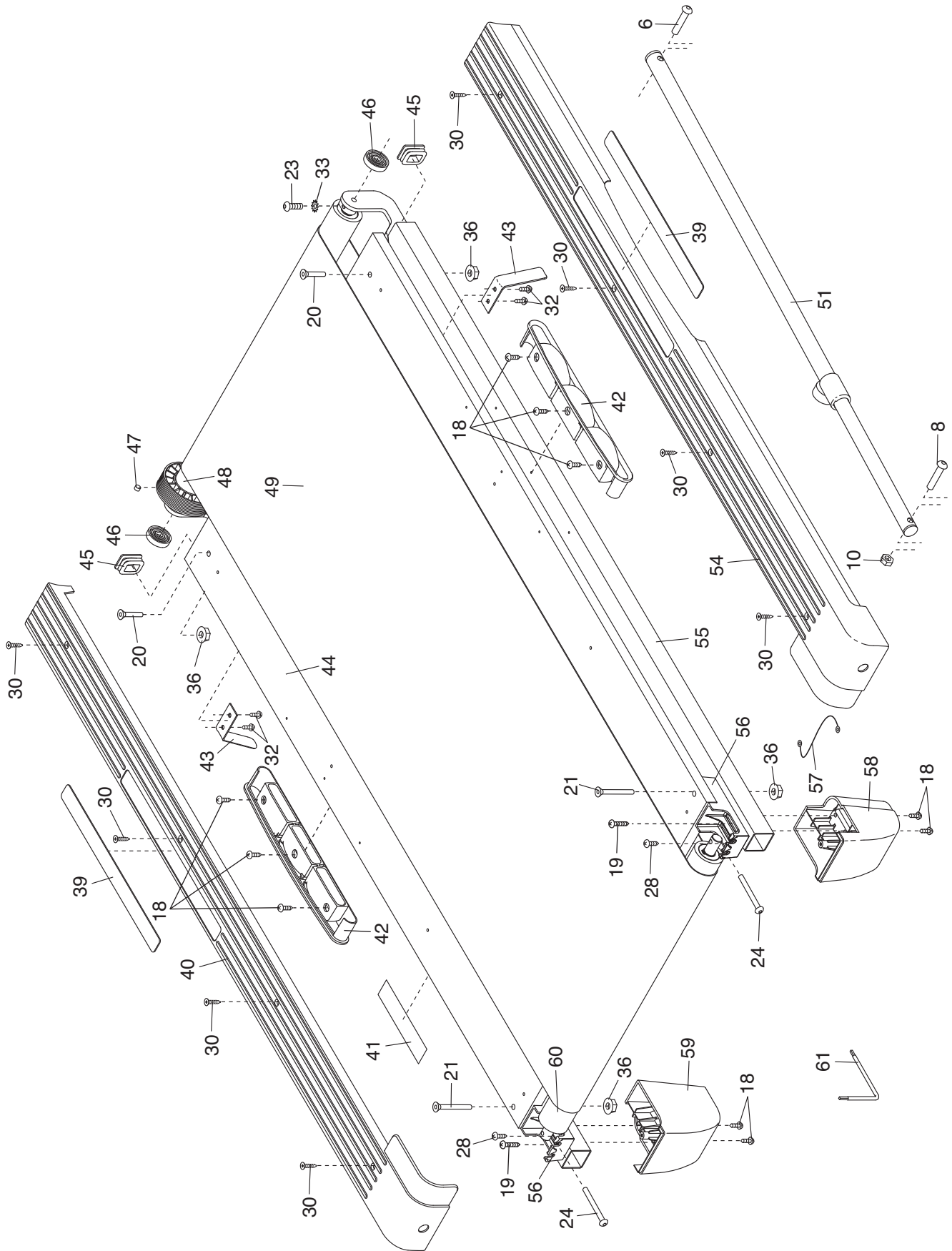

EXPLODED DRAWING B

Model No. PFTL49611.1 R0611A

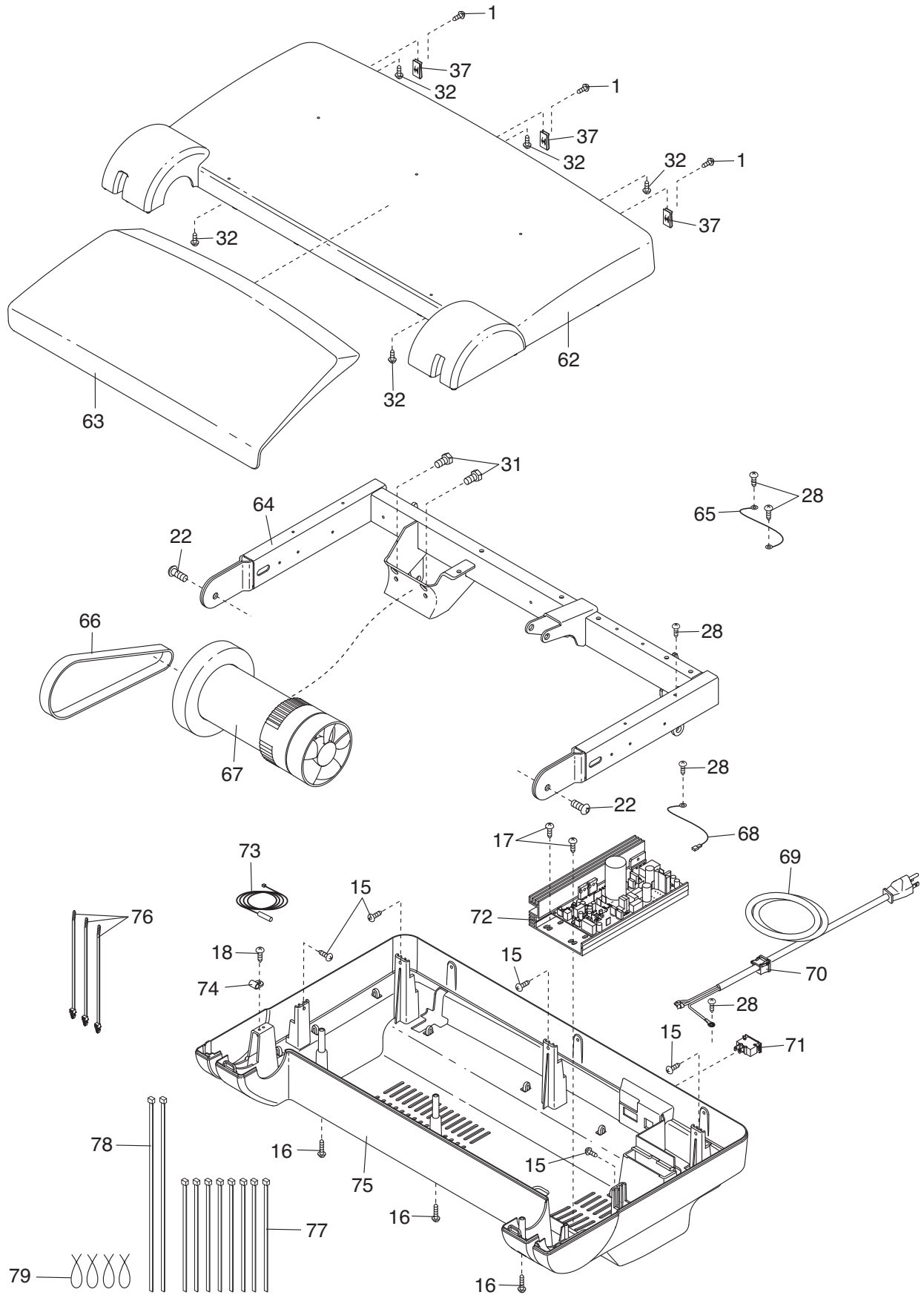

EXPLODED DRAWING C

Model No. PFTL49611.1 R0611A

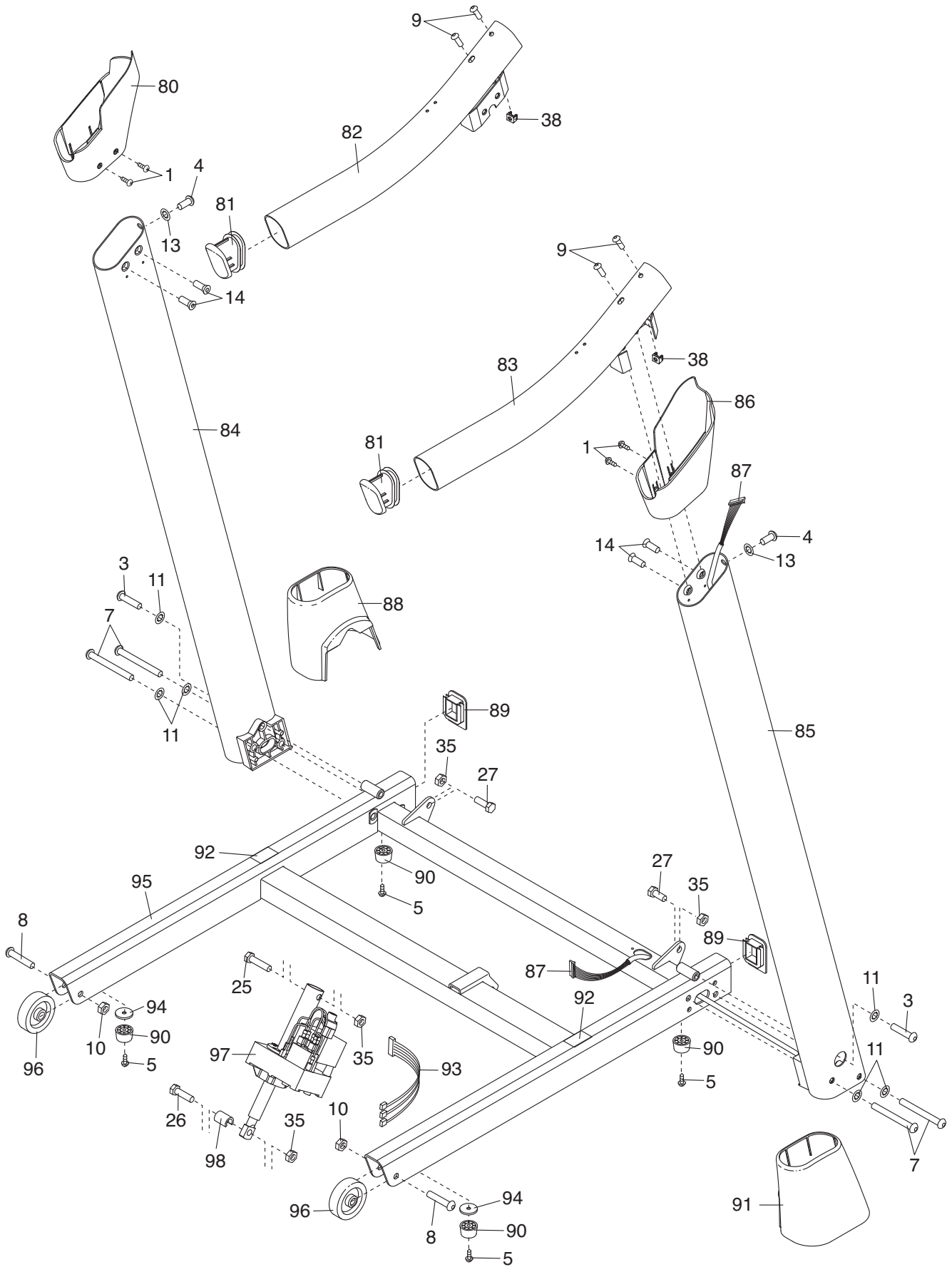

EXPLODED DRAWING D

Model No. PFTL49611.1 R0611A

