

EXPLODED DRAWING A

Model No. PFTL49612.0 R0612A

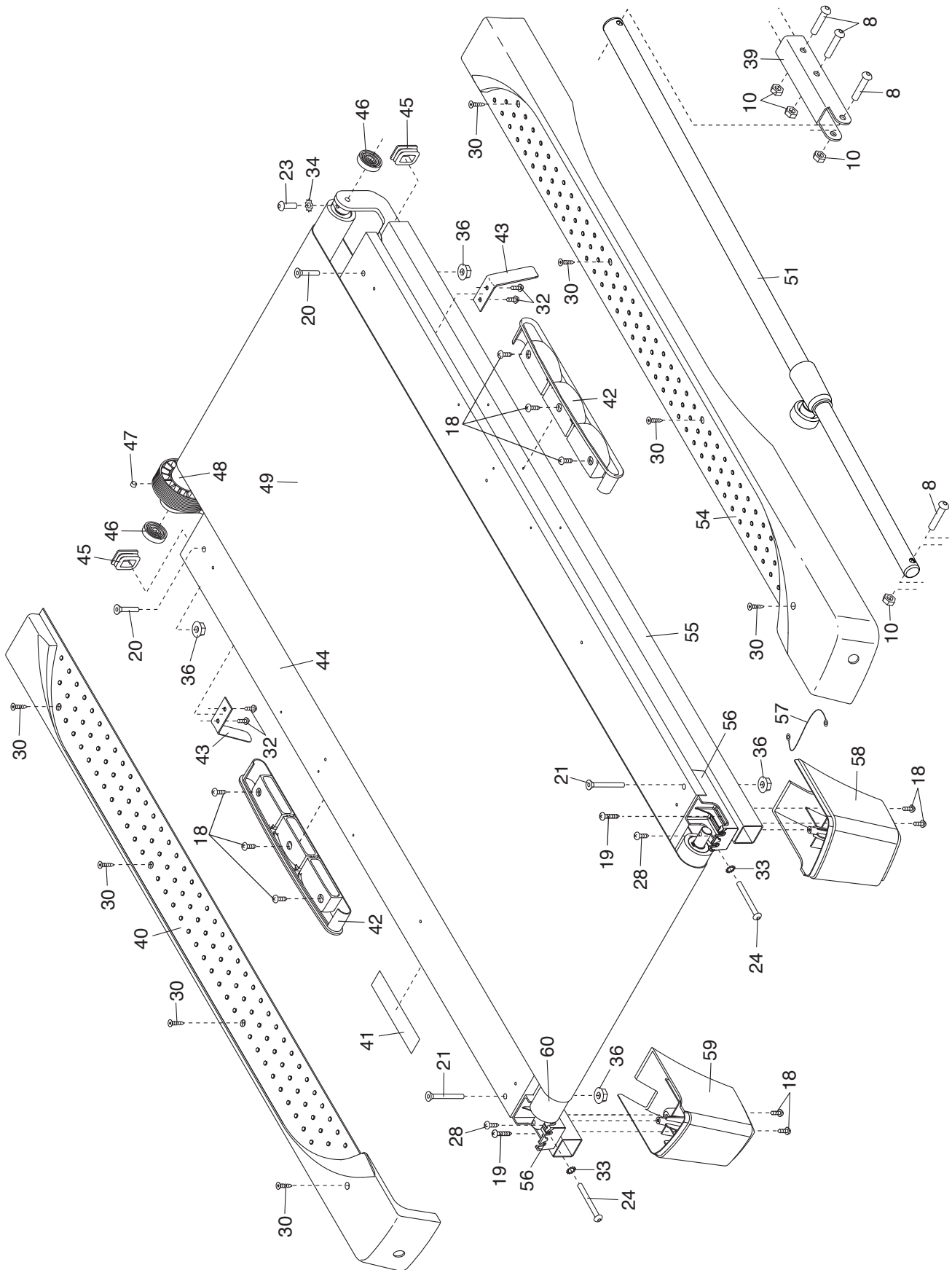

EXPLODED DRAWING B

Model No. PFTL49612.0 R0612A

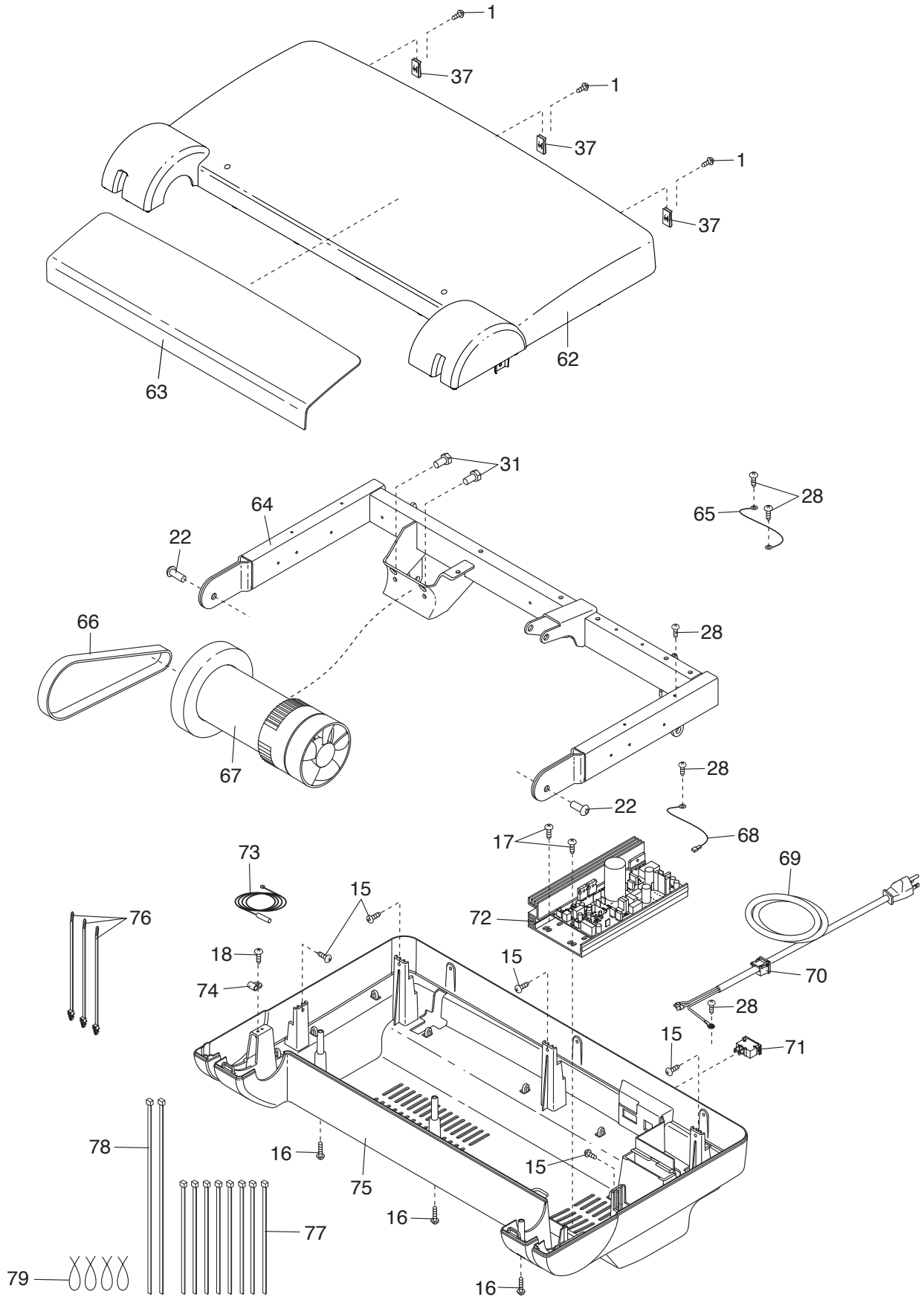

EXPLODED DRAWING C

Model No. PFTL49612.0 R0612A

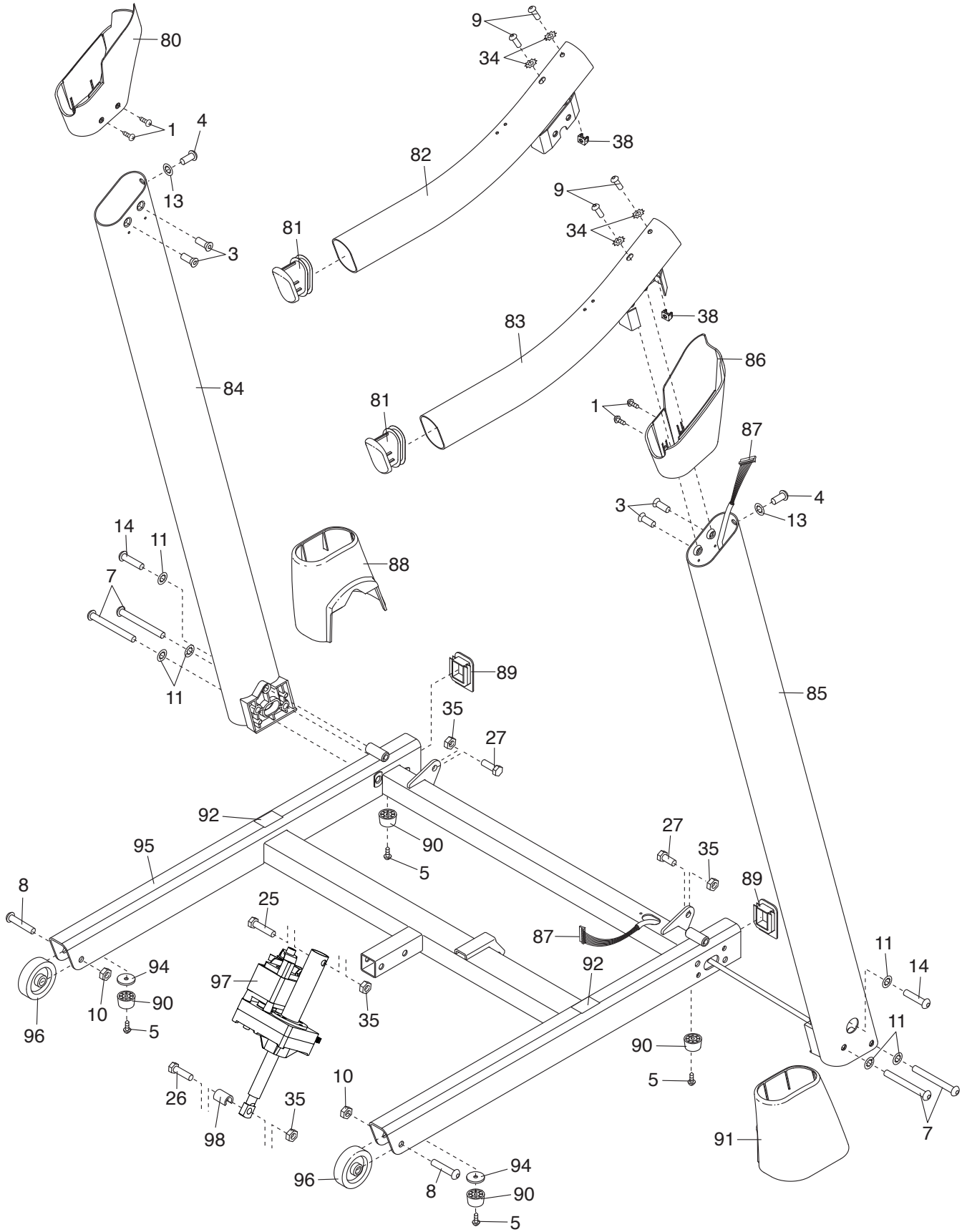

EXPLODED DRAWING D

Model No. PFTL49612.0 R0612A

