

EXPLODED DRAWING A

Model No. PFTL49616.0 R0816B

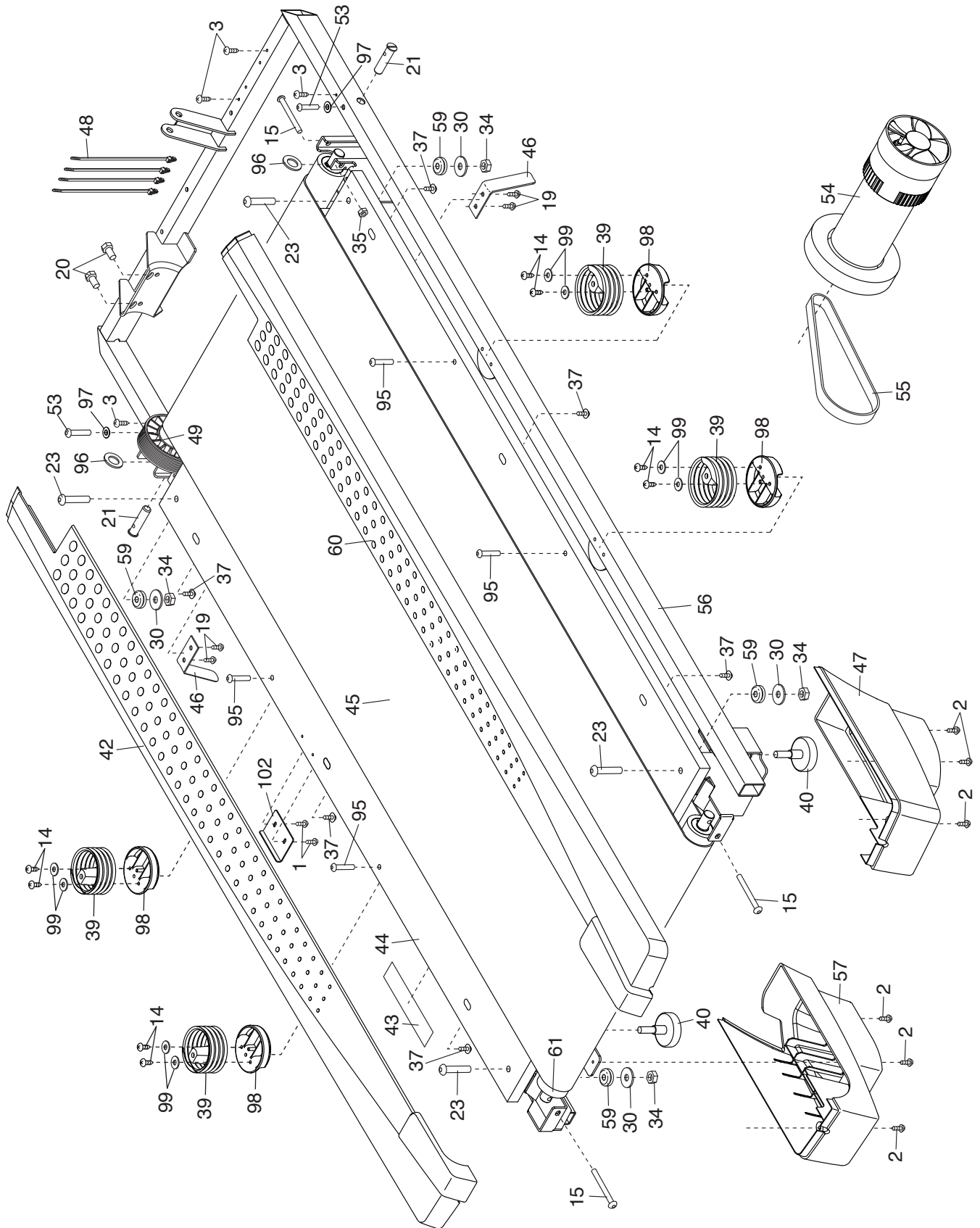

EXPLODED DRAWING B

Model No. PFTL49616.0 R0816B

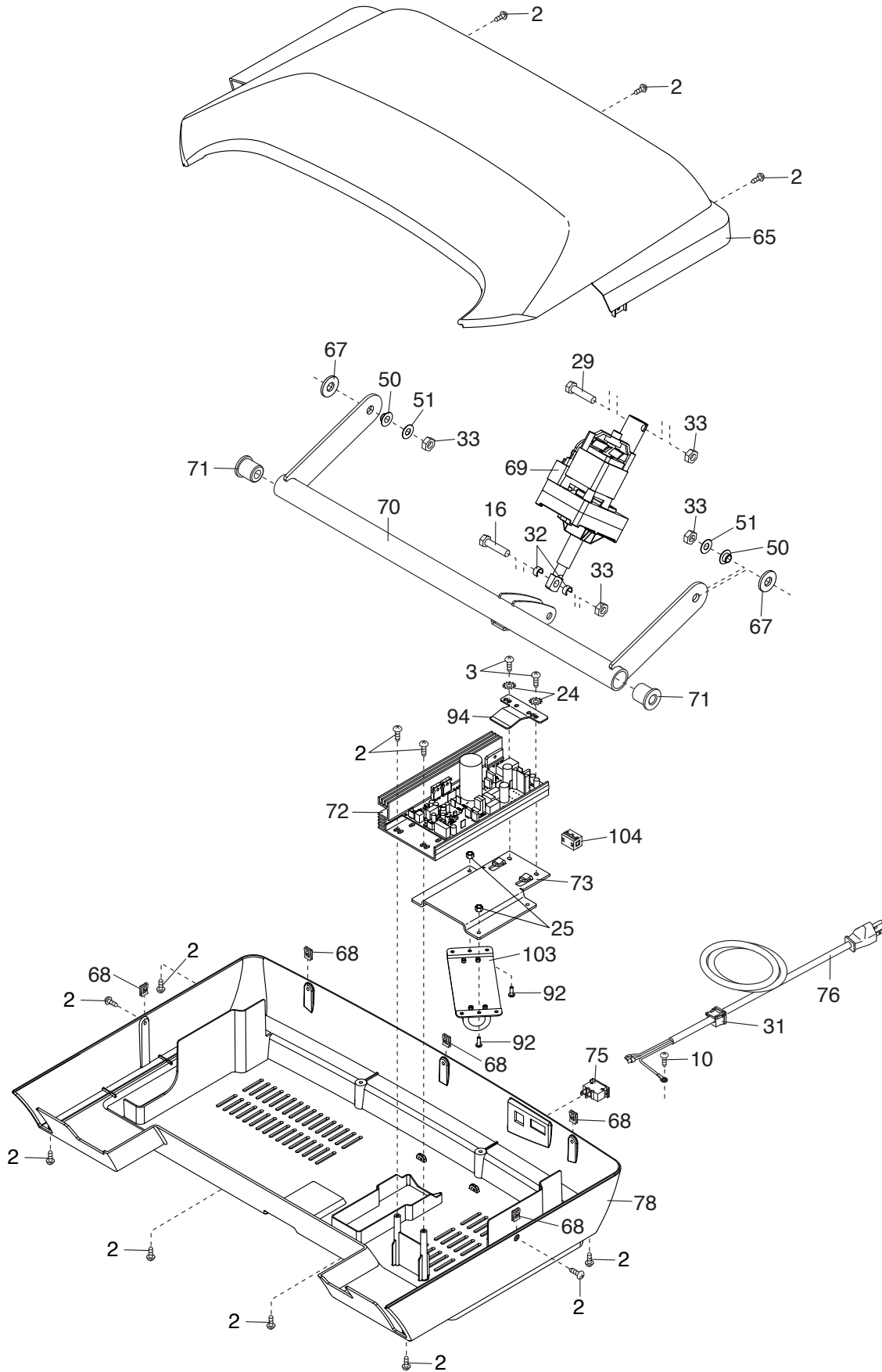

EXPLODED DRAWING C

Model No. PFTL49616.0 R0816B

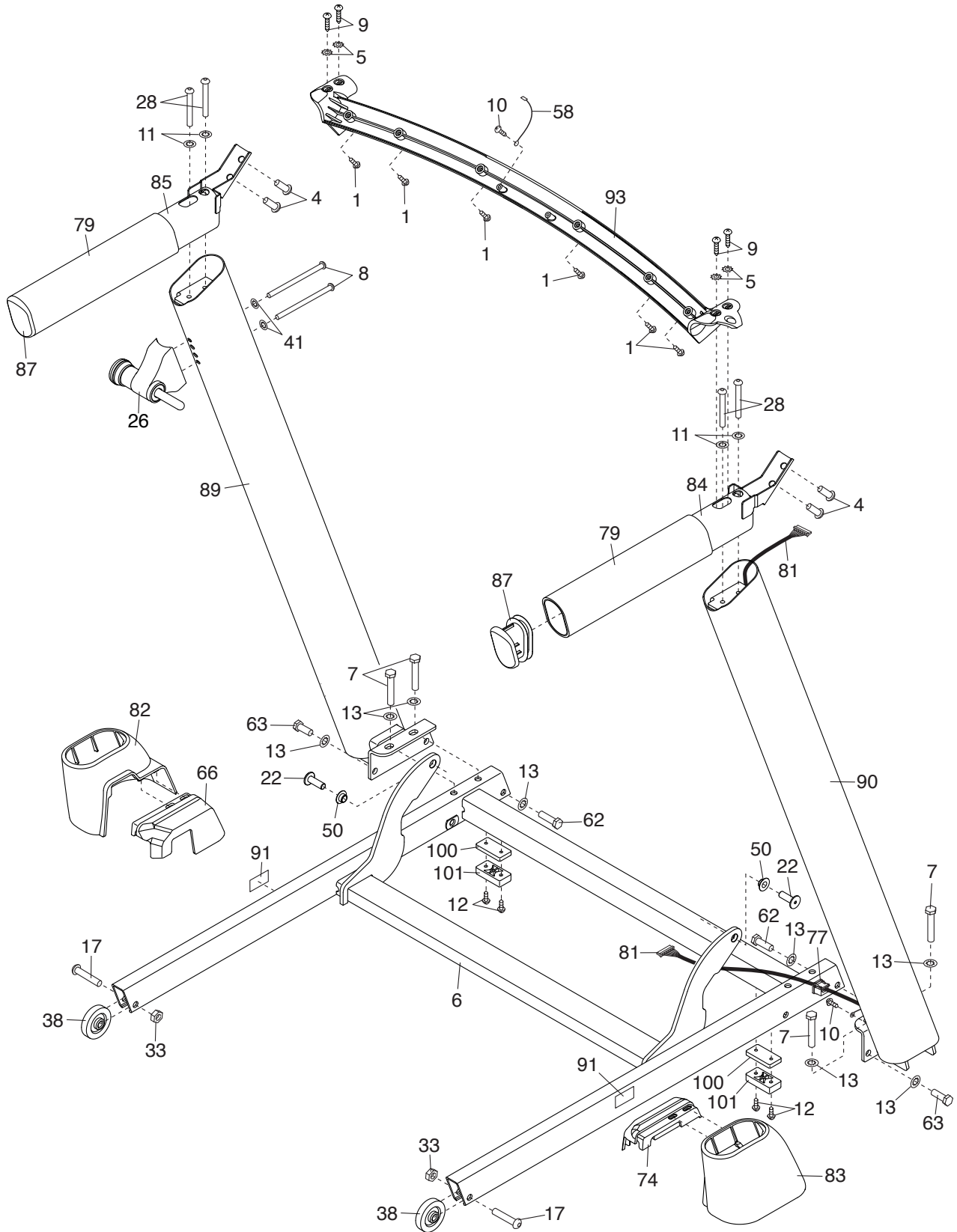

EXPLODED DRAWING D

Model No. PFTL49616.0 R0816B

