

EXPLODED DRAWING A

Model No. PFTL49617.3 R1118A

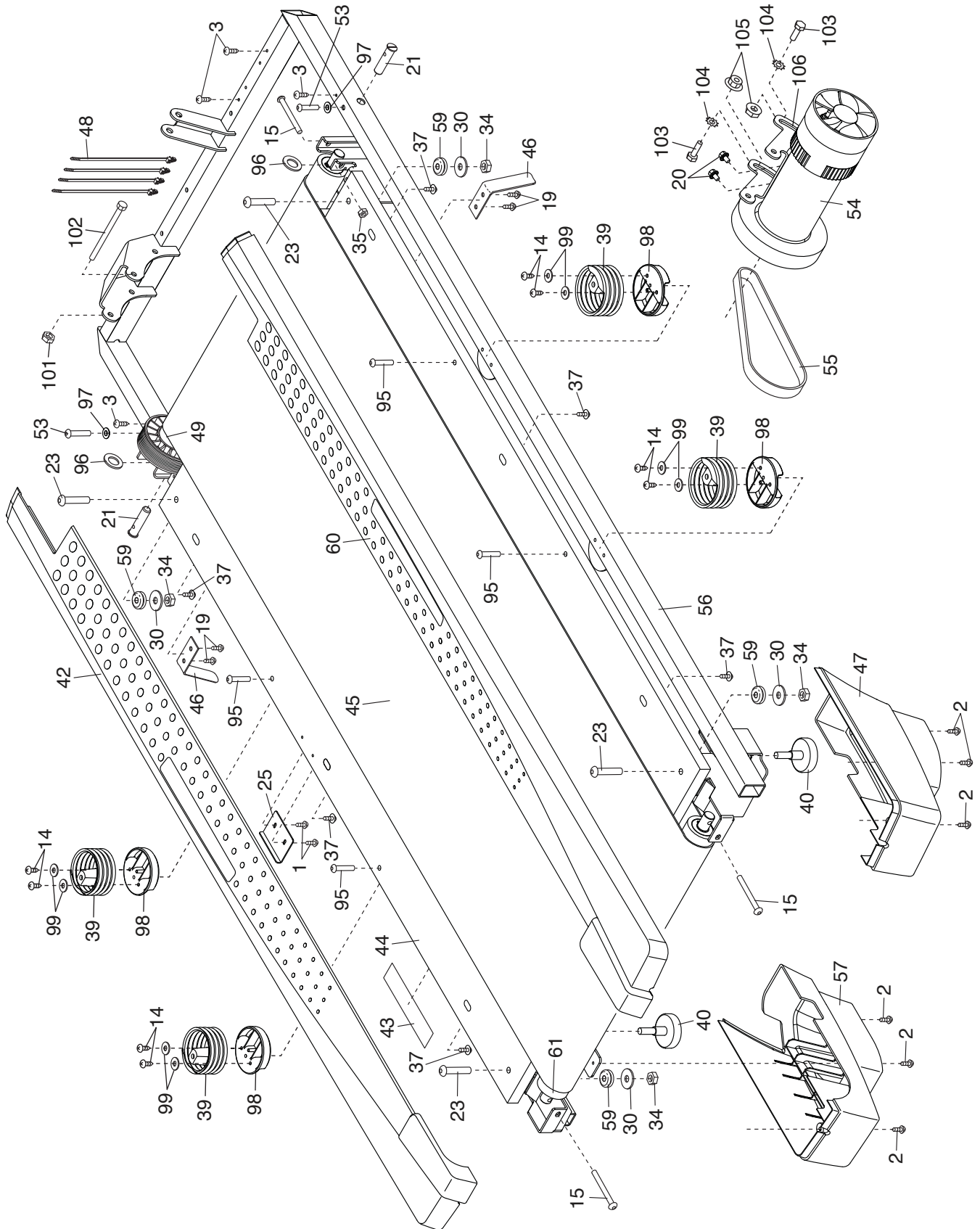

EXPLODED DRAWING B

Model No. PFTL49617.3 R1118A

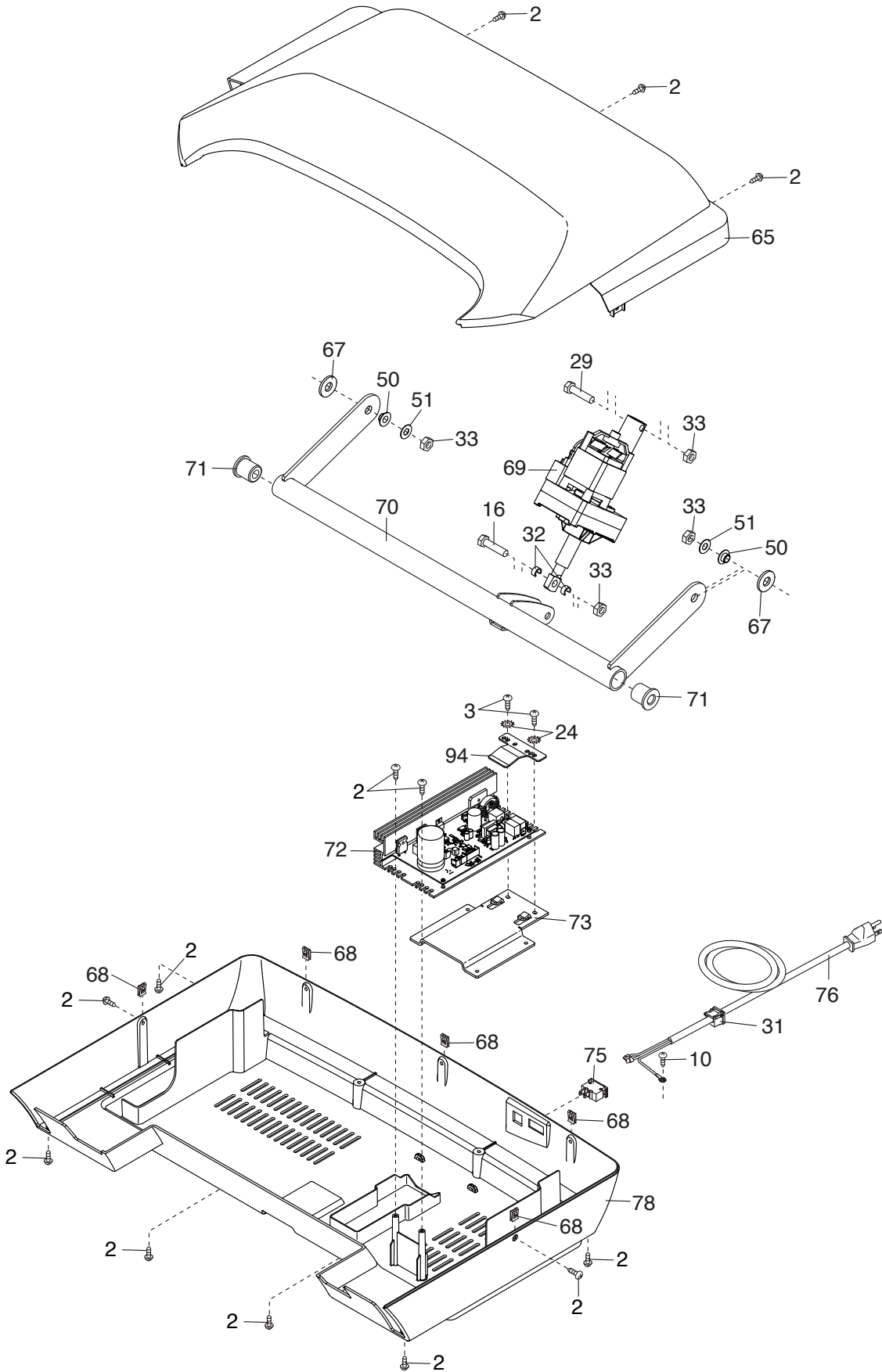

EXPLODED DRAWING C

Model No. PFTL49617.3 R1118A

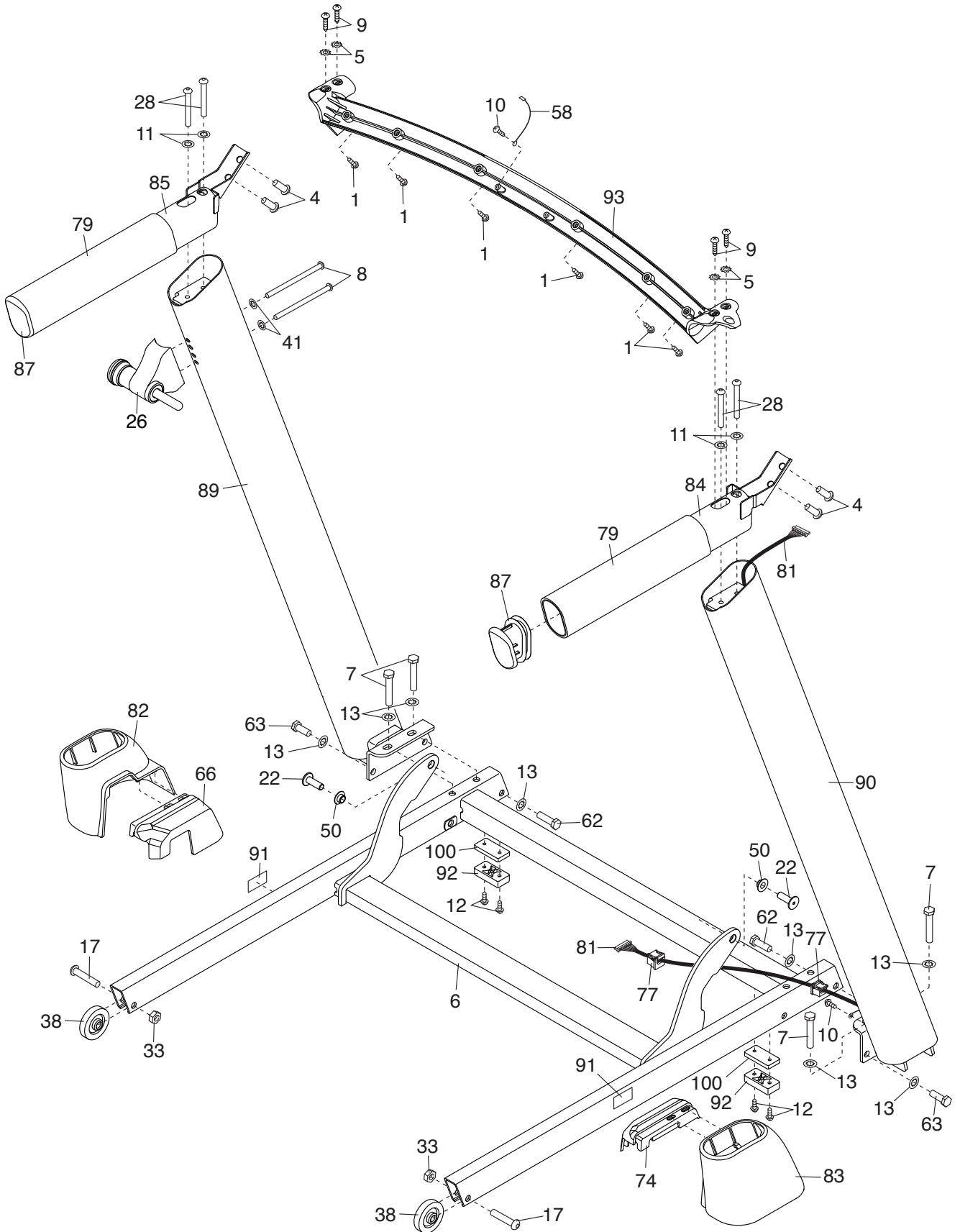

EXPLODED DRAWING D

Model No. PFTL49617.3 R1118A

