

EXPLODED DRAWING A

Model No. PFTL49617.4 R0319A

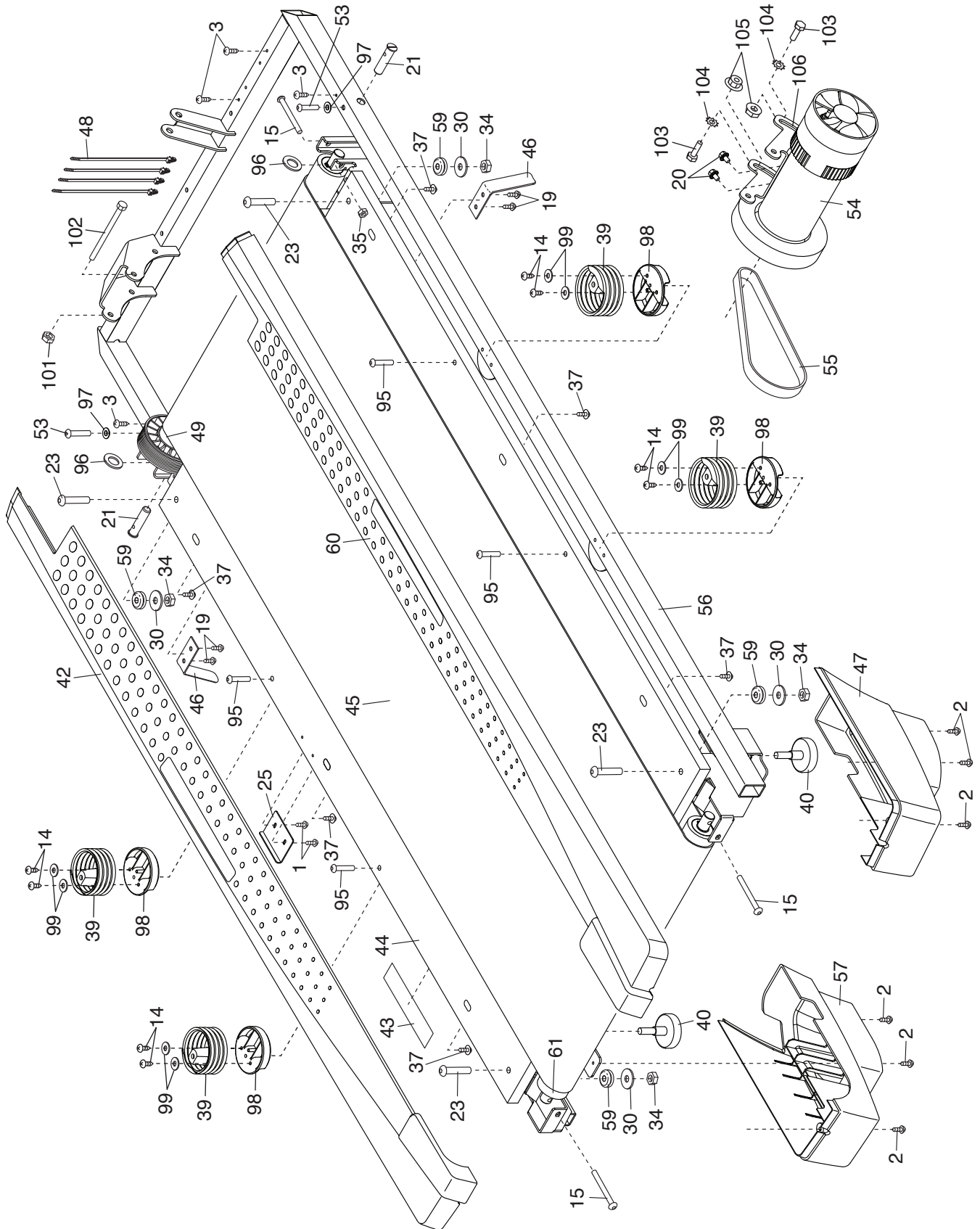

EXPLODED DRAWING B

Model No. PFTL49617.4 R0319A

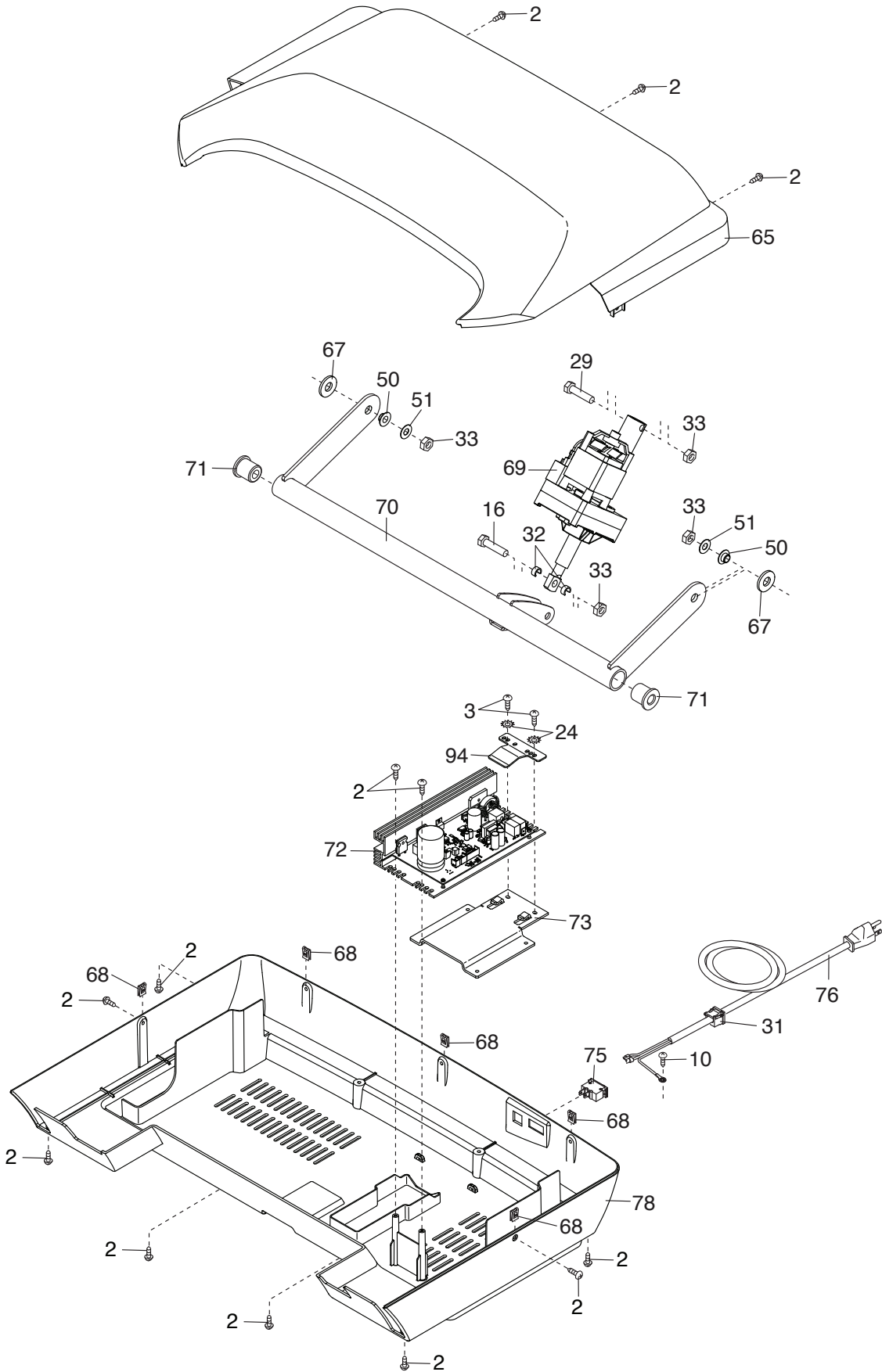

EXPLODED DRAWING C

Model No. PFTL49617.4 R0319A

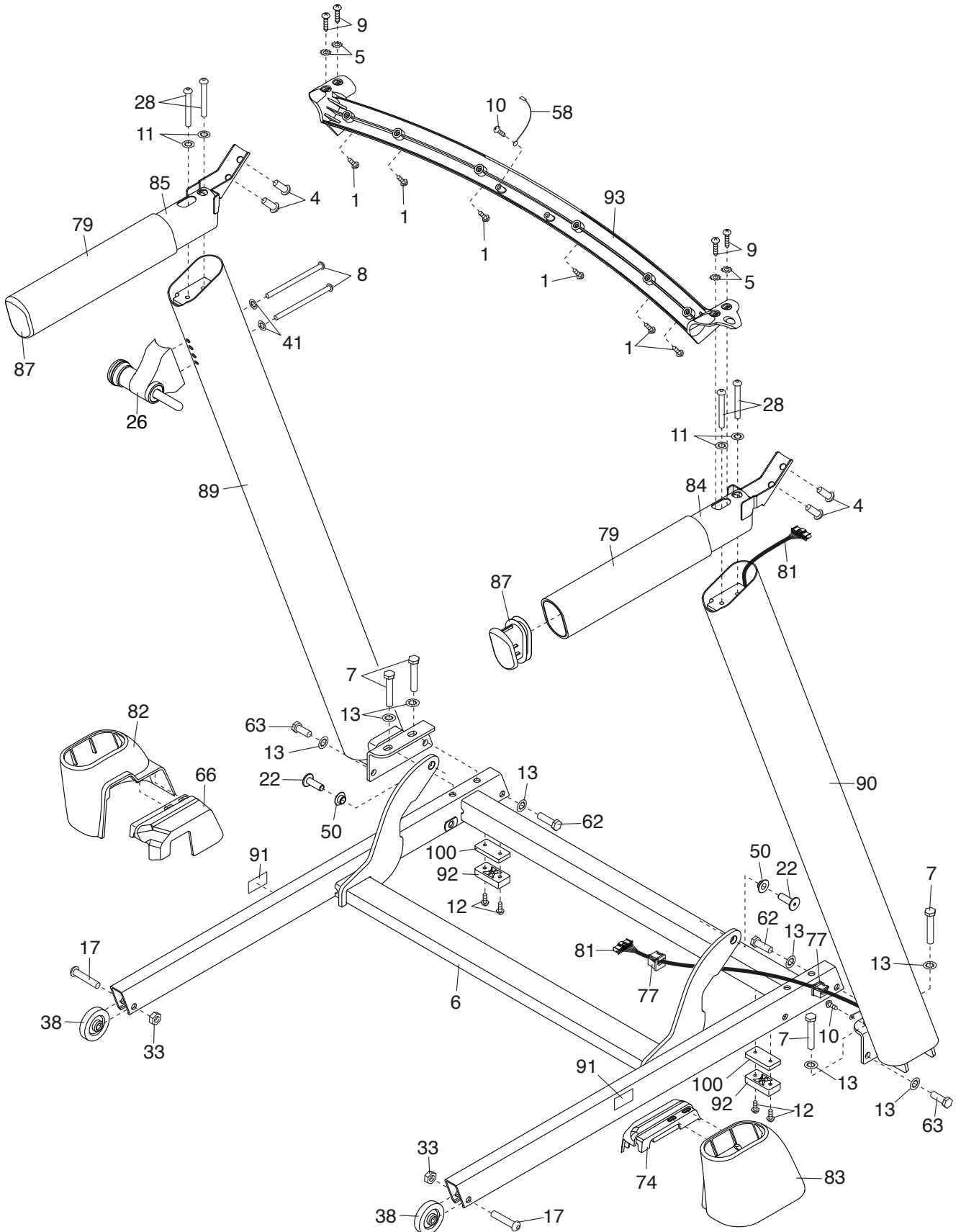

EXPLODED DRAWING D

Model No. PFTL49617.4 R0319A

