

EXPLODED DRAWING A

Model No. PFTL49621.0 R0711A

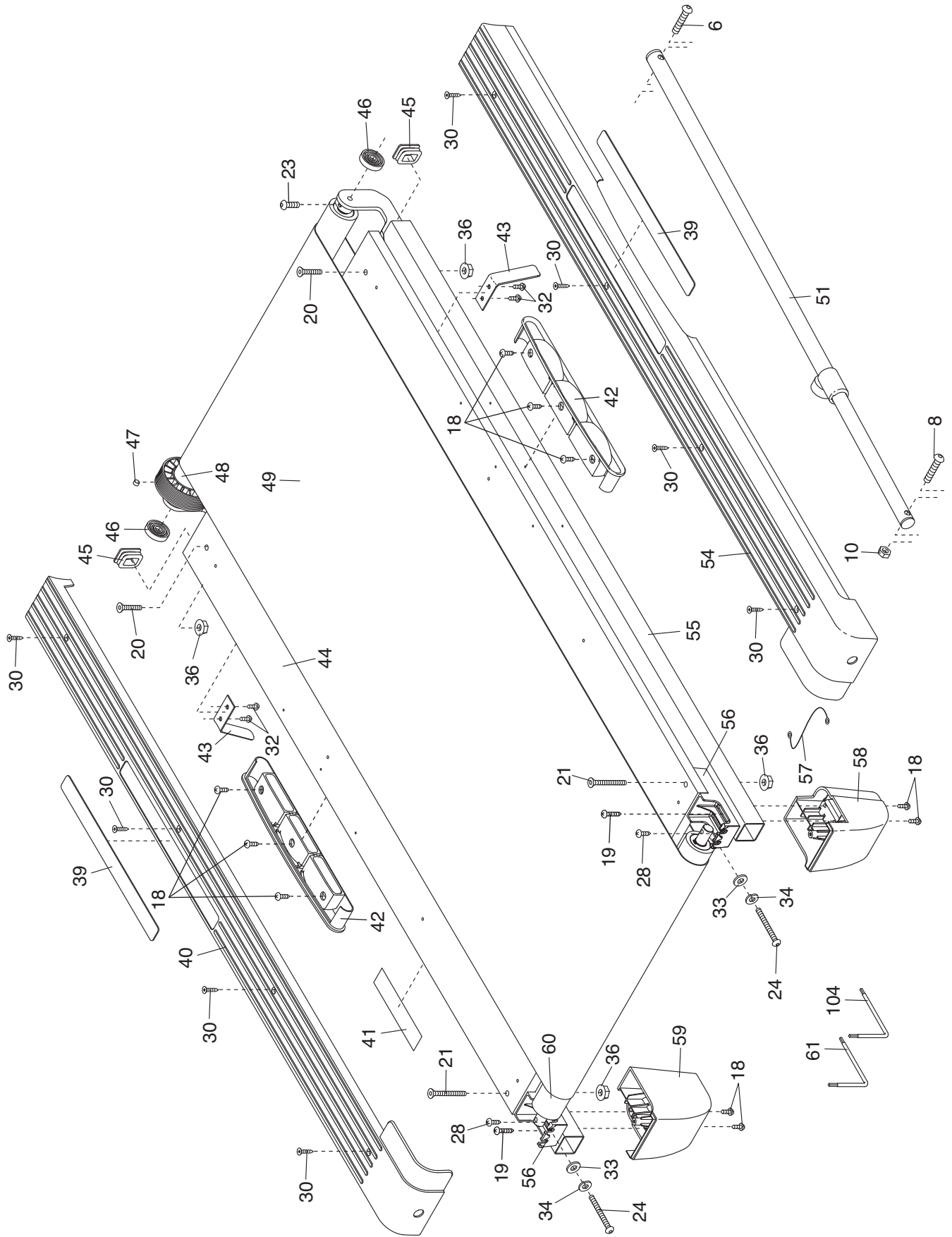

EXPLODED DRAWING B

Model No. PFTL49621.0 R0711A

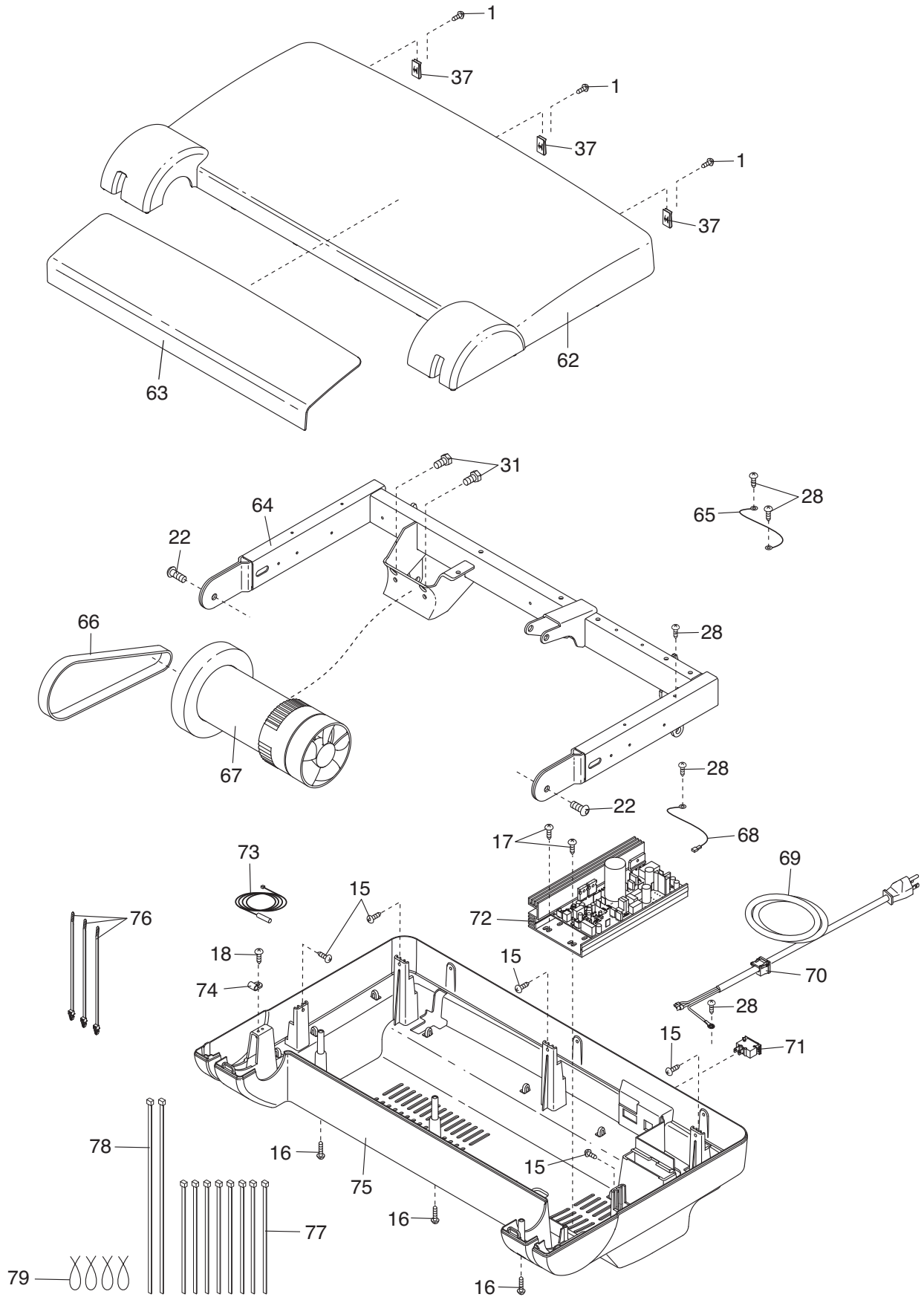

EXPLODED DRAWING C

Model No. PFTL49621.0 R0711A

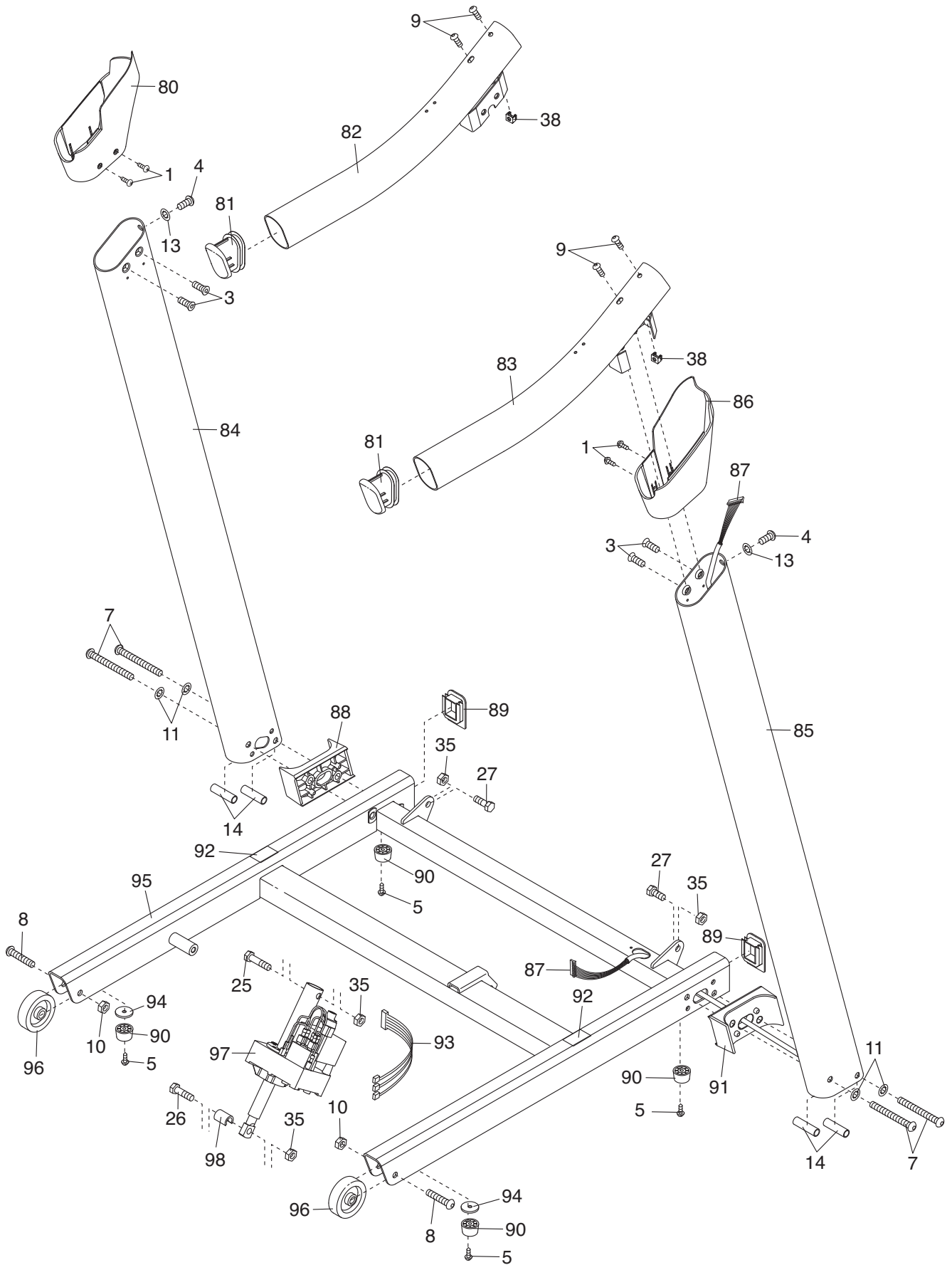

EXPLODED DRAWING D

Model No. PFTL49621.0 R0711A

