

EXPLODED DRAWING A—Model No. PFTL49807.0

R0707A

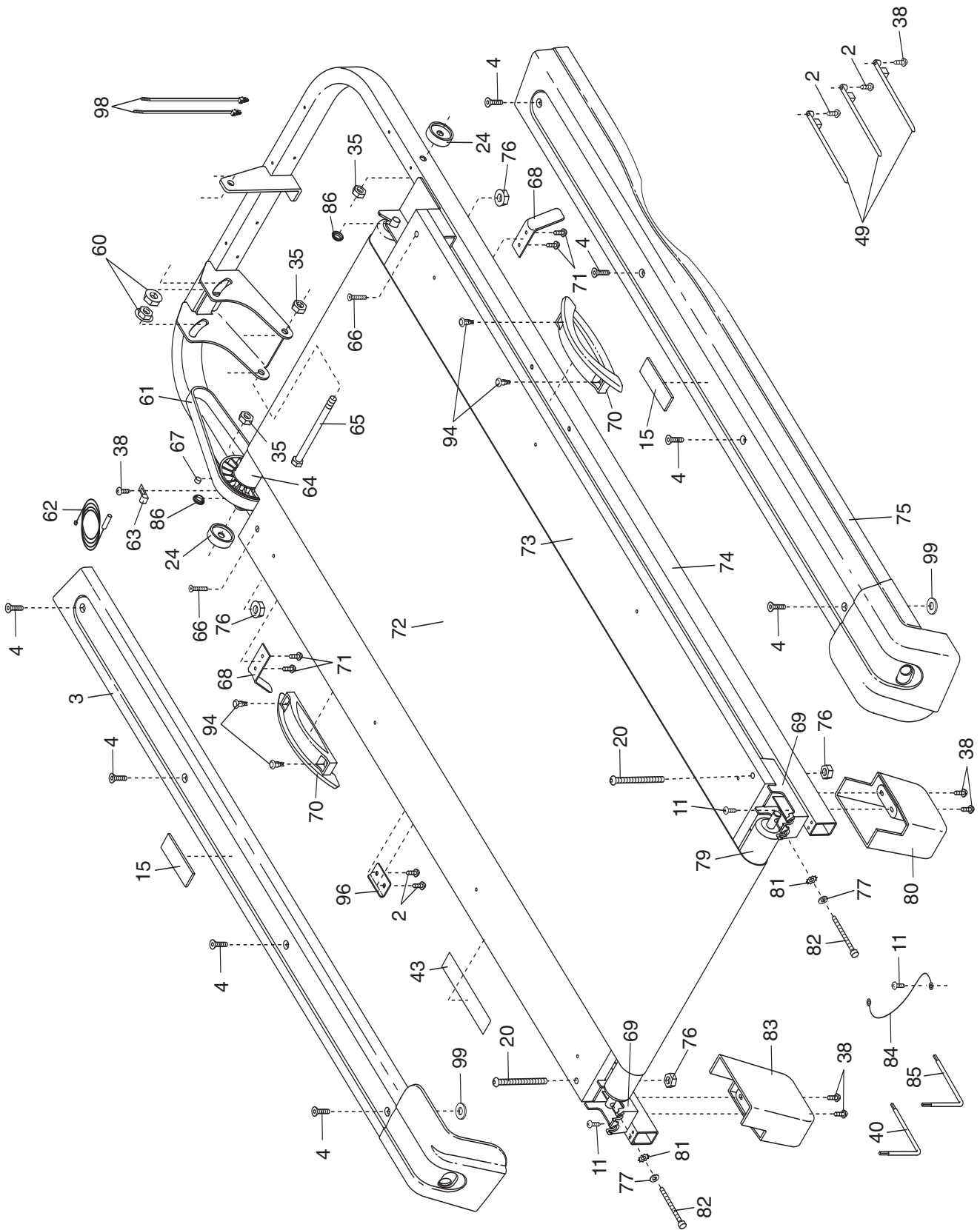

EXPLODED DRAWING B—Model No. PFTL49807.0

R0707A

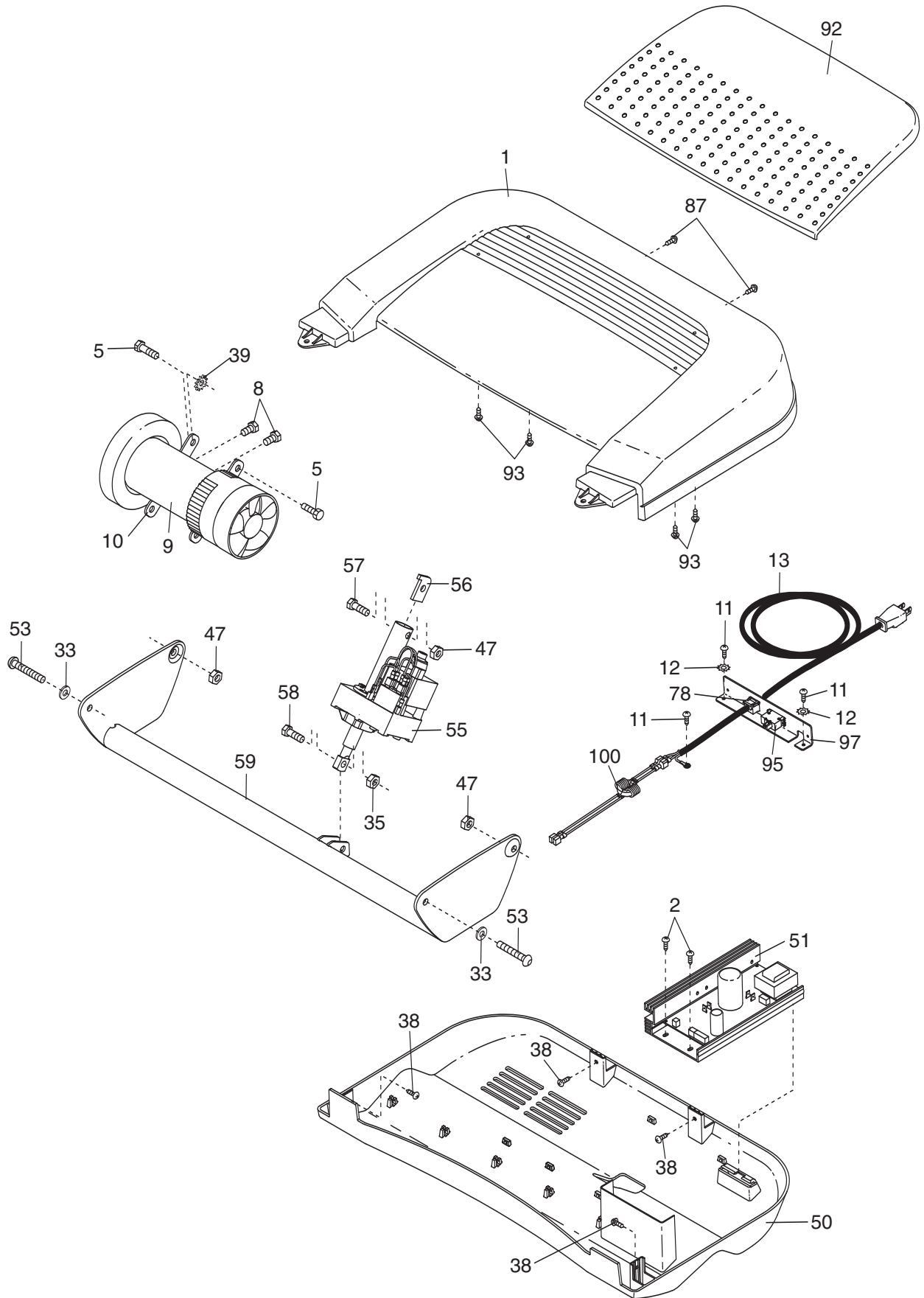

EXPLODED DRAWING C—Model No. PFTL49807.0

R0707A

