

# EXPLODED DRAWING A—Model No. PFTL49906.0

R1106A

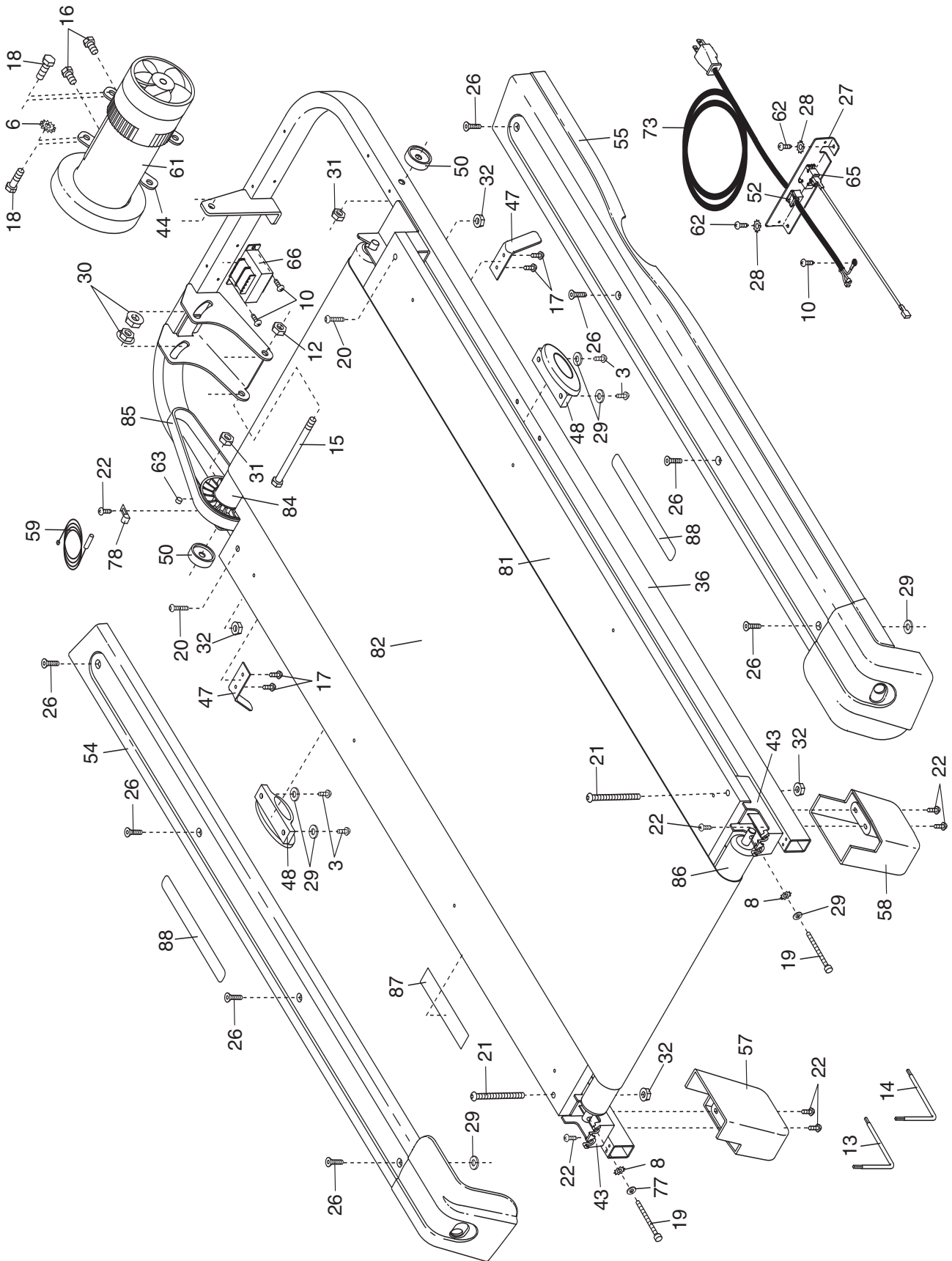

# EXPLODED DRAWING B—Model No. PFTL49906.0

R1106A

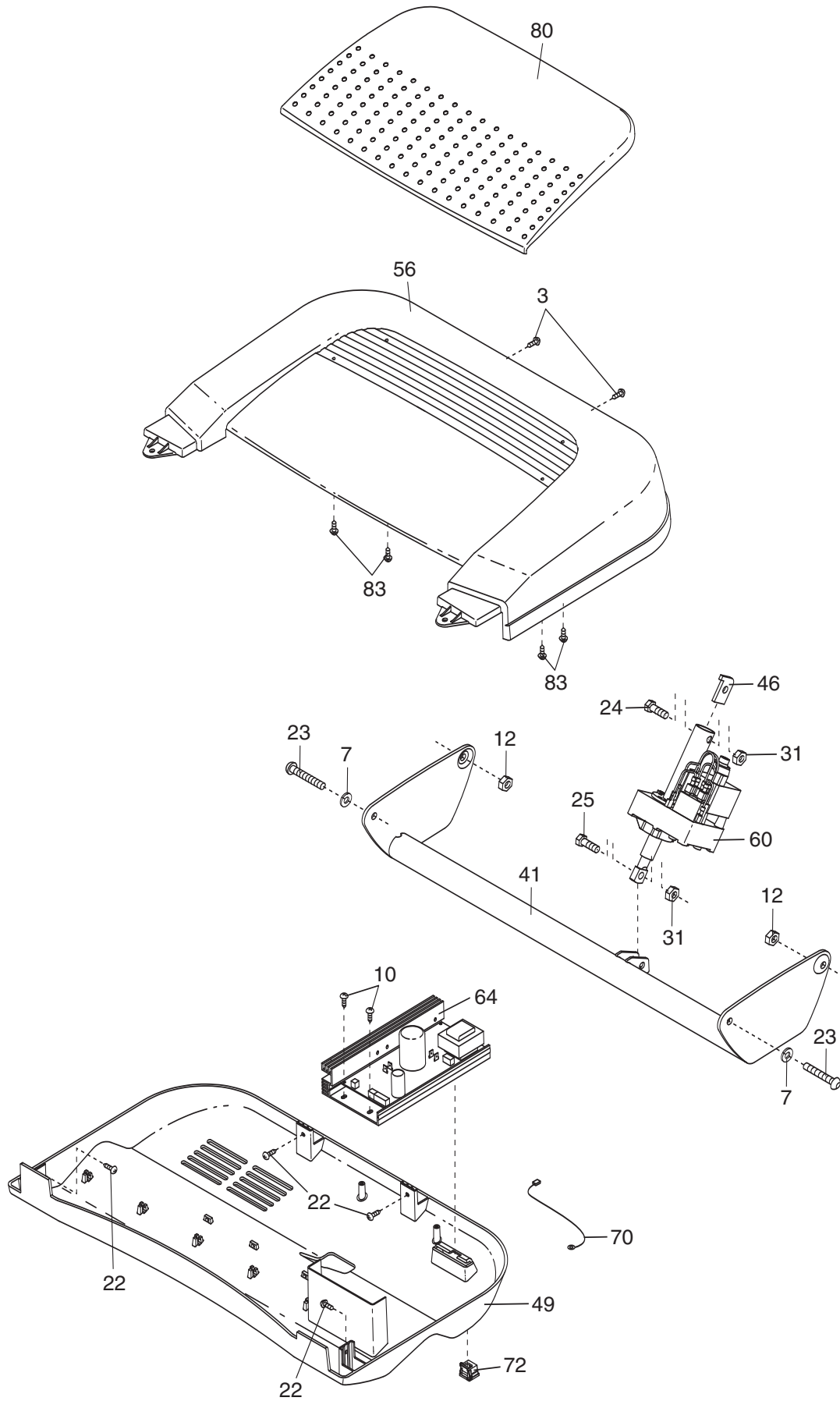

# EXPLODED DRAWING C—Model No. PFTL49906.0

R1106A

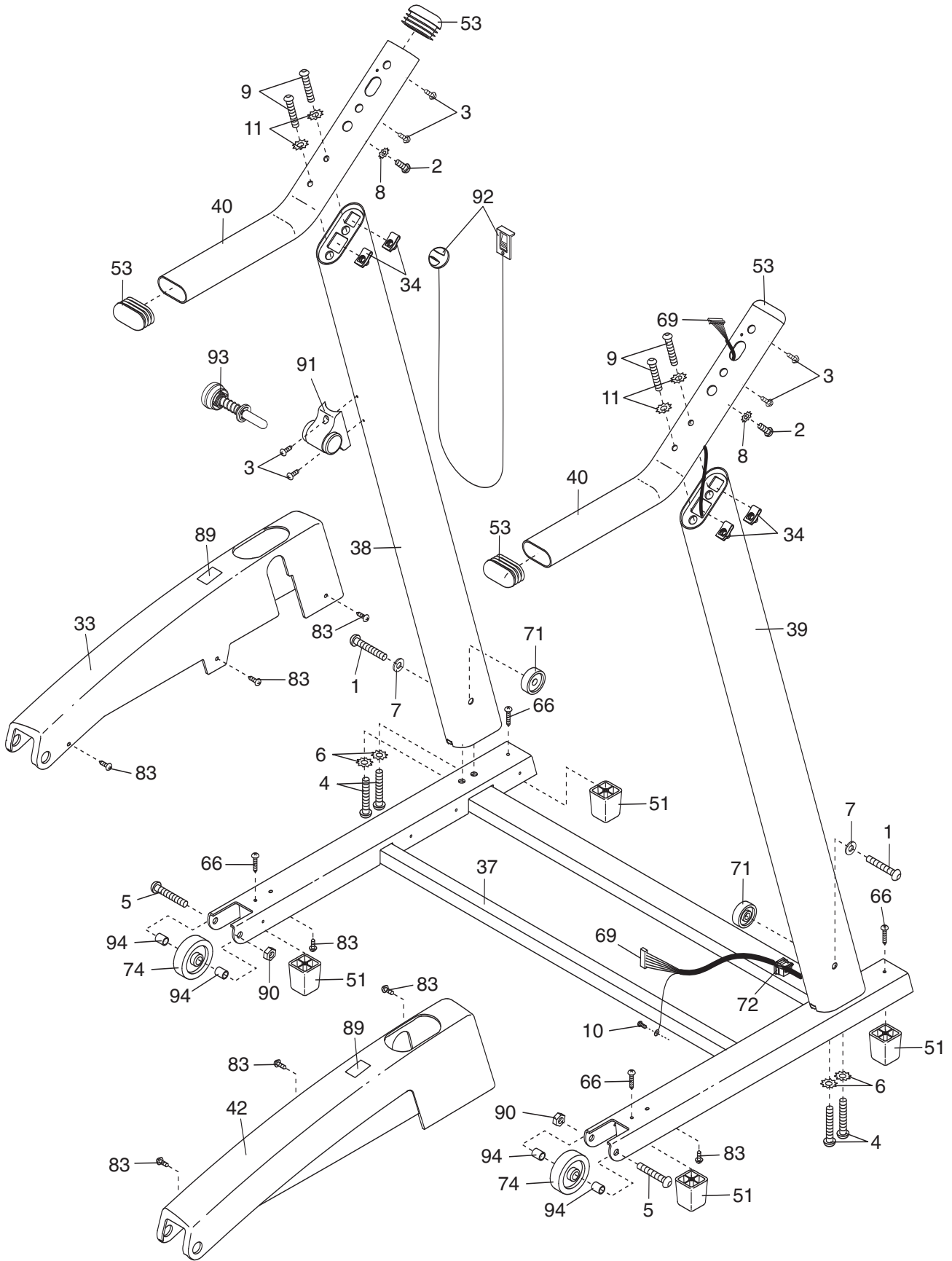

# EXPLODED DRAWING D—Model No. PFTL49906.0

R1106A

