

# EXPLODED DRAWING A—Model No. PFTL49908.0

R1008A

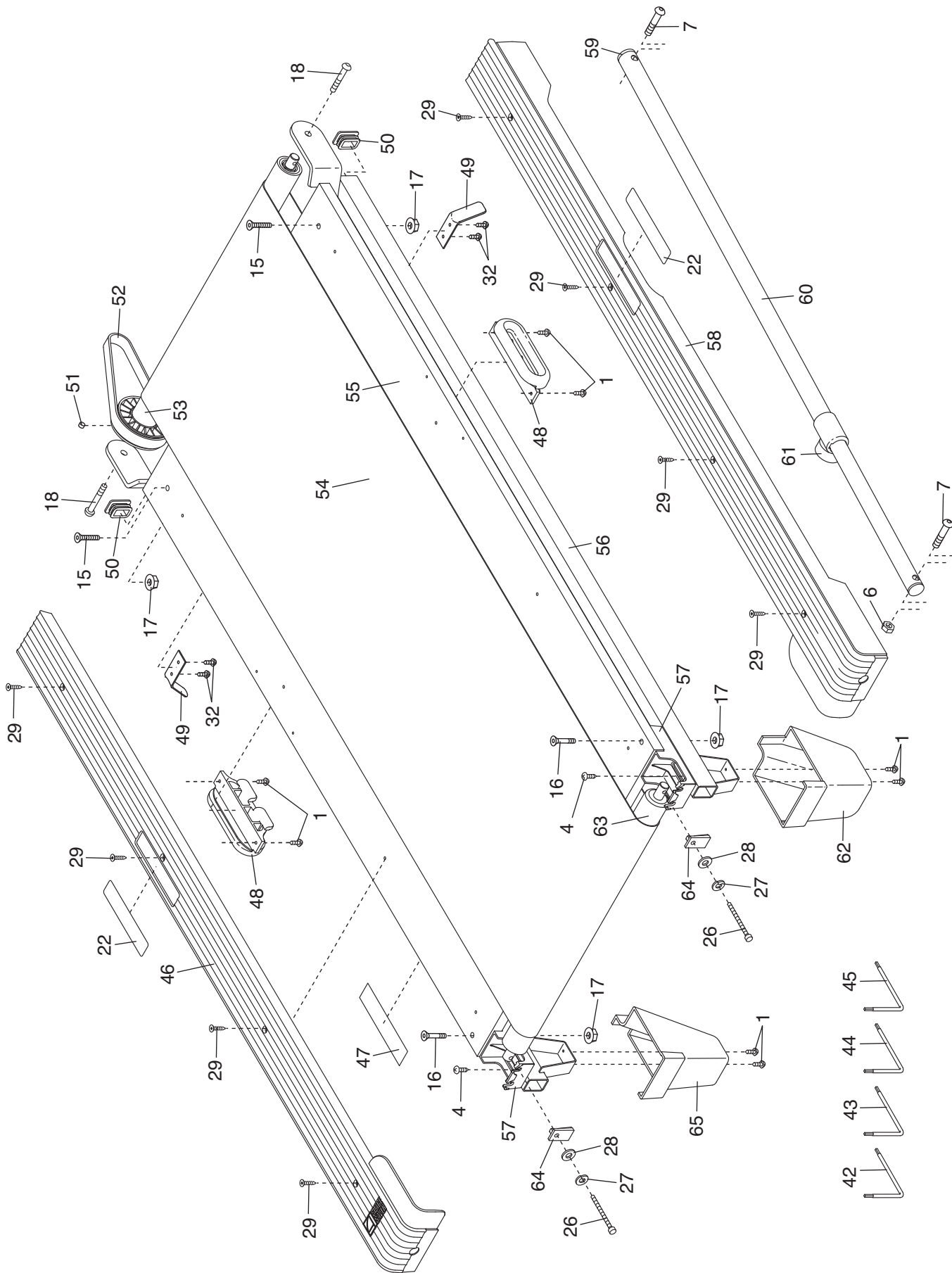

# EXPLODED DRAWING B—Model No. PFTL49908.0

R1008A

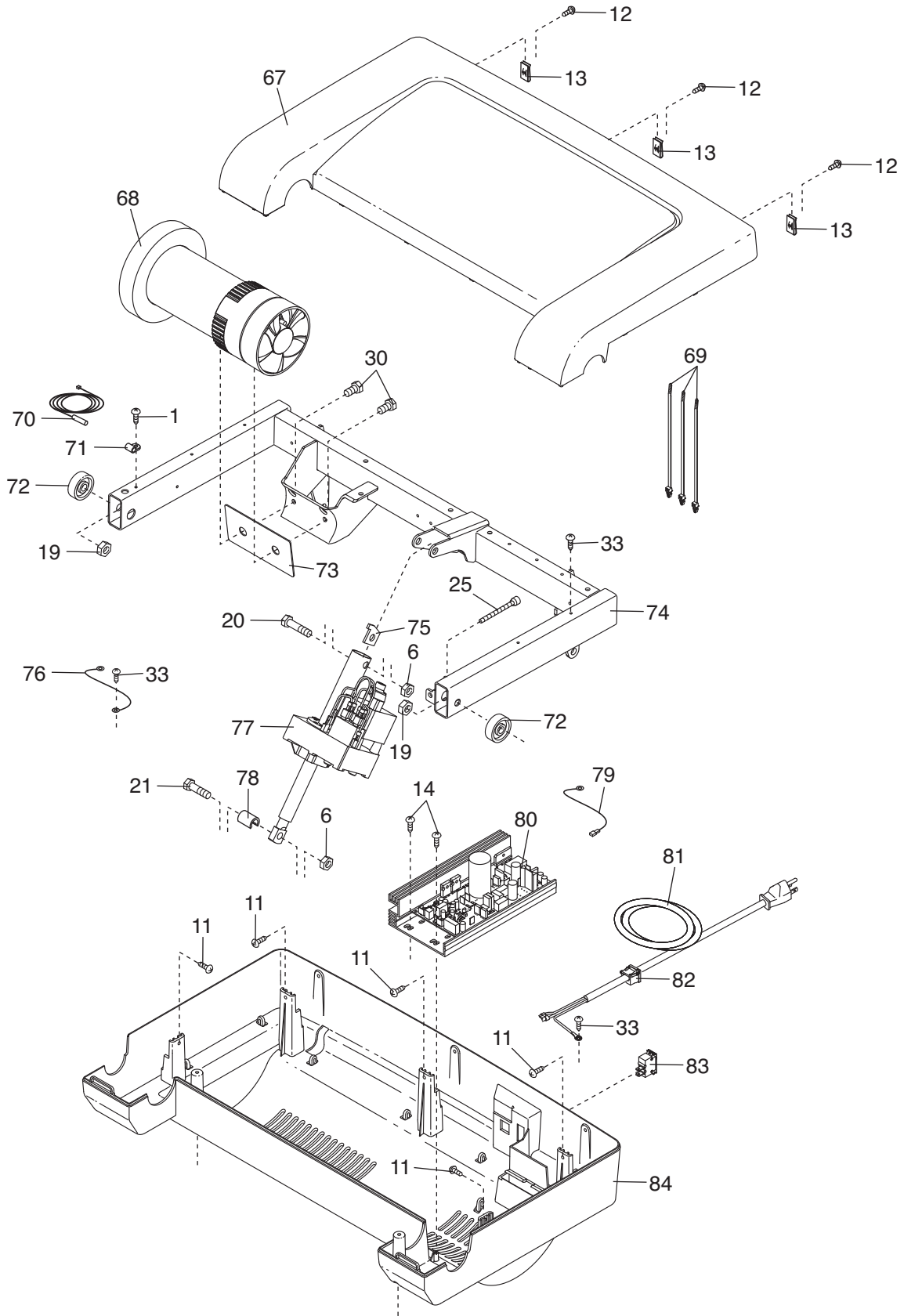

# EXPLODED DRAWING C—Model No. PFTL49908.0

R1008A

