

EXPLODED DRAWING A—Model No. PFTL49908.2

R1208A

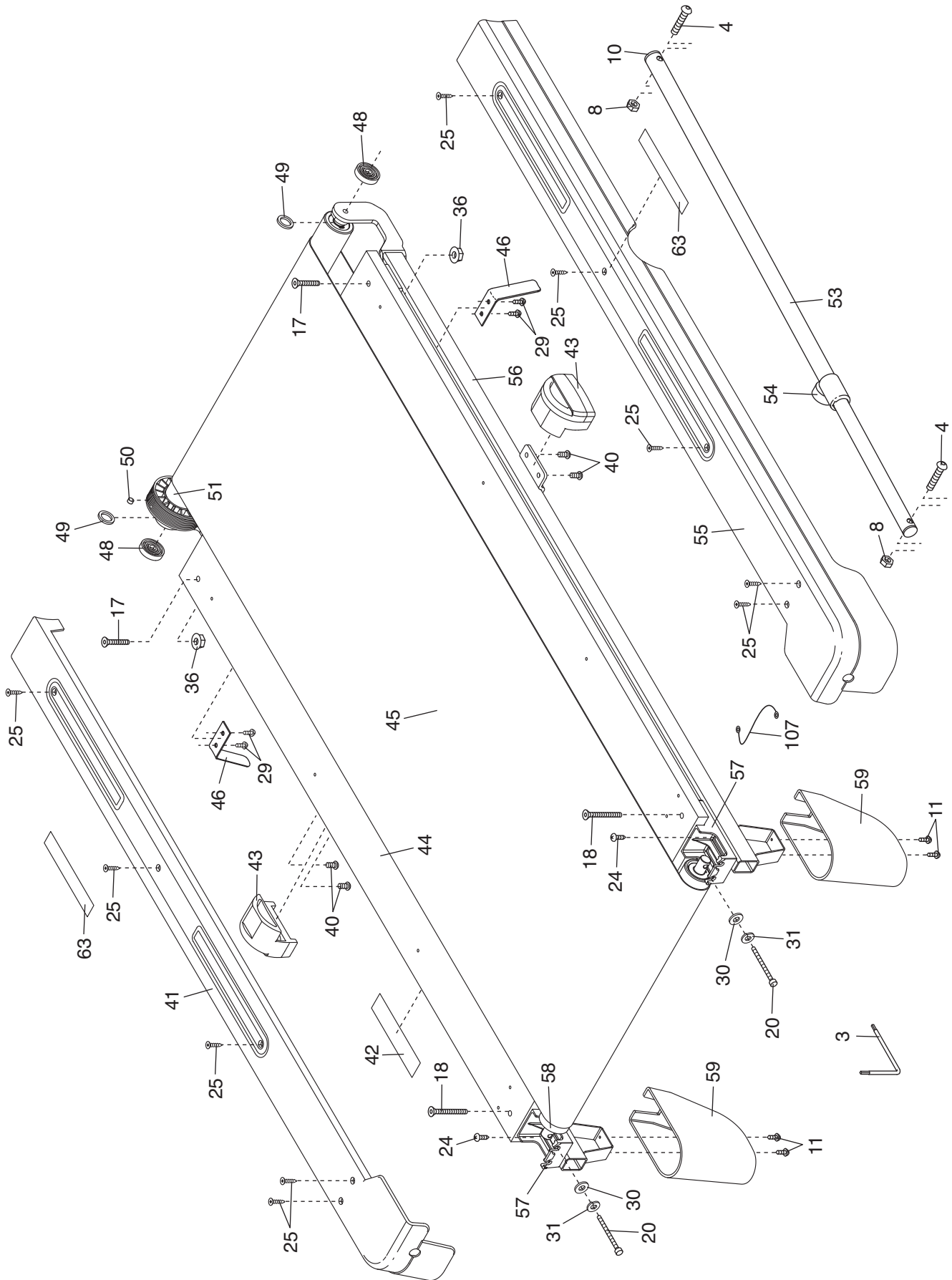

EXPLODED DRAWING B—Model No. PFTL49908.2

R1208A

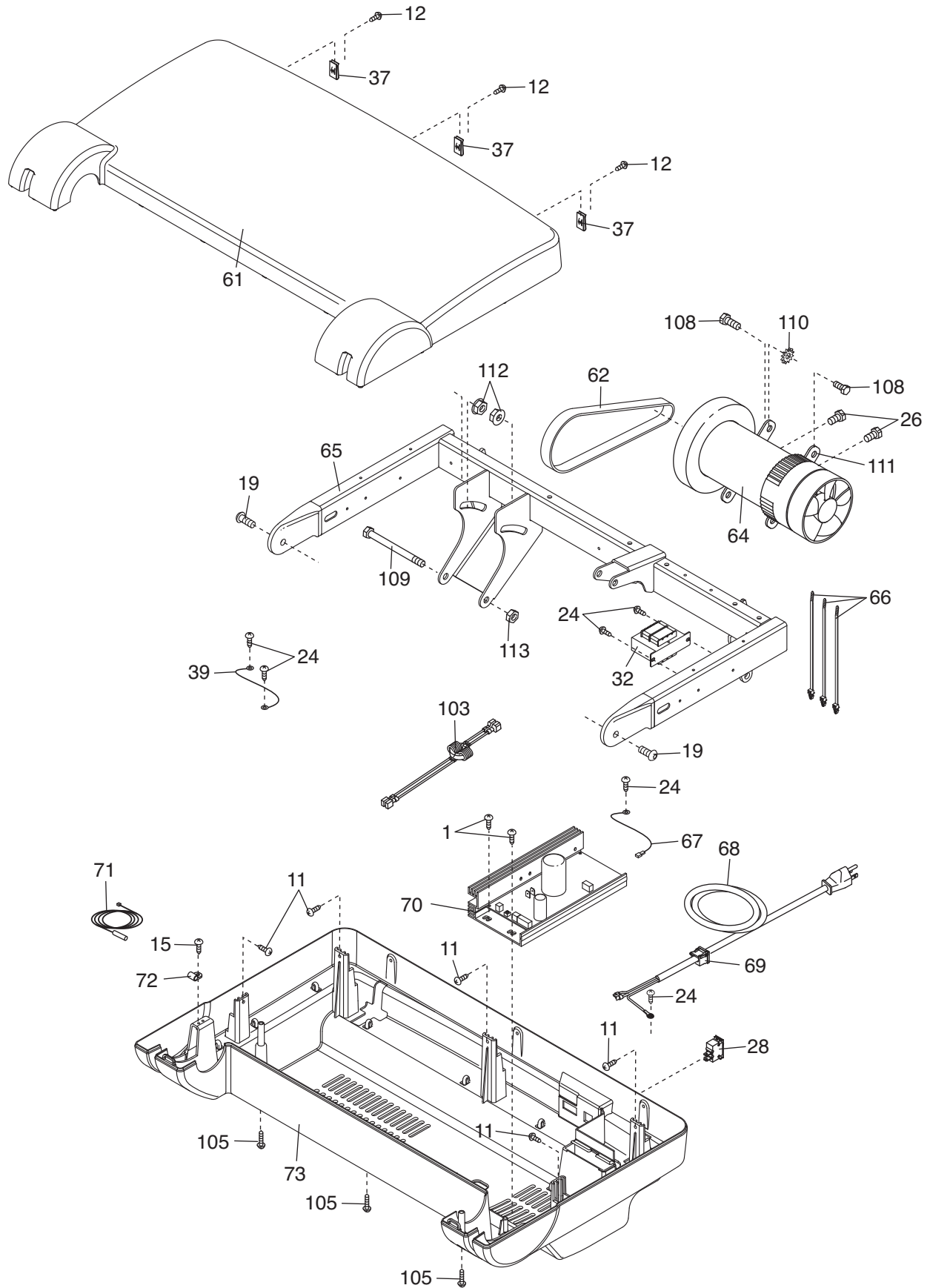

EXPLODED DRAWING C—Model No. PFTL49908.2

R1208A

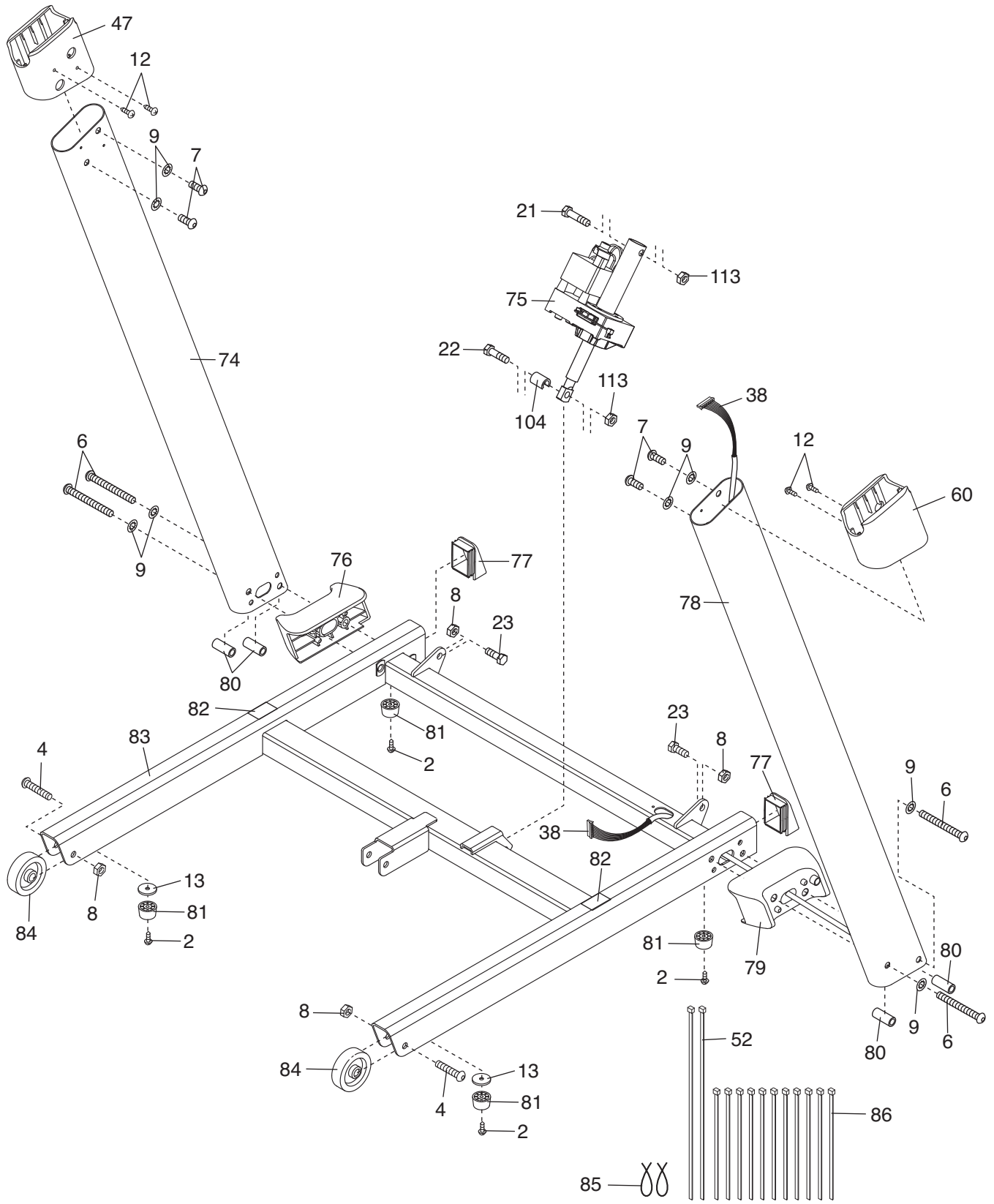

EXPLODED DRAWING D—Model No. PFTL49908.2

R1208A

