

EXPLODED DRAWING—Model No. PFTL51233

R0104A

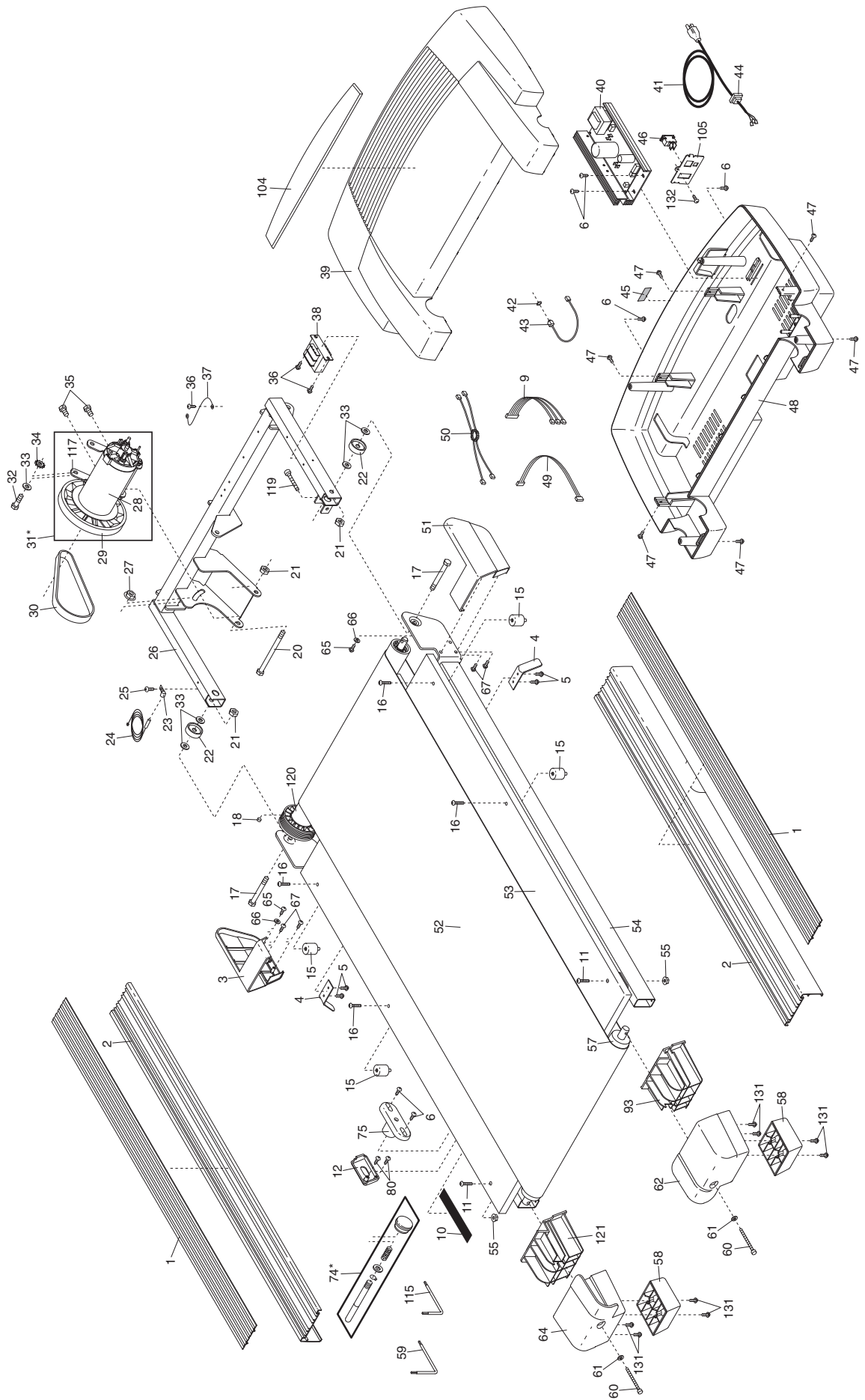

EXPLODED DRAWING—Model No. PFTL51233

R0104A

