

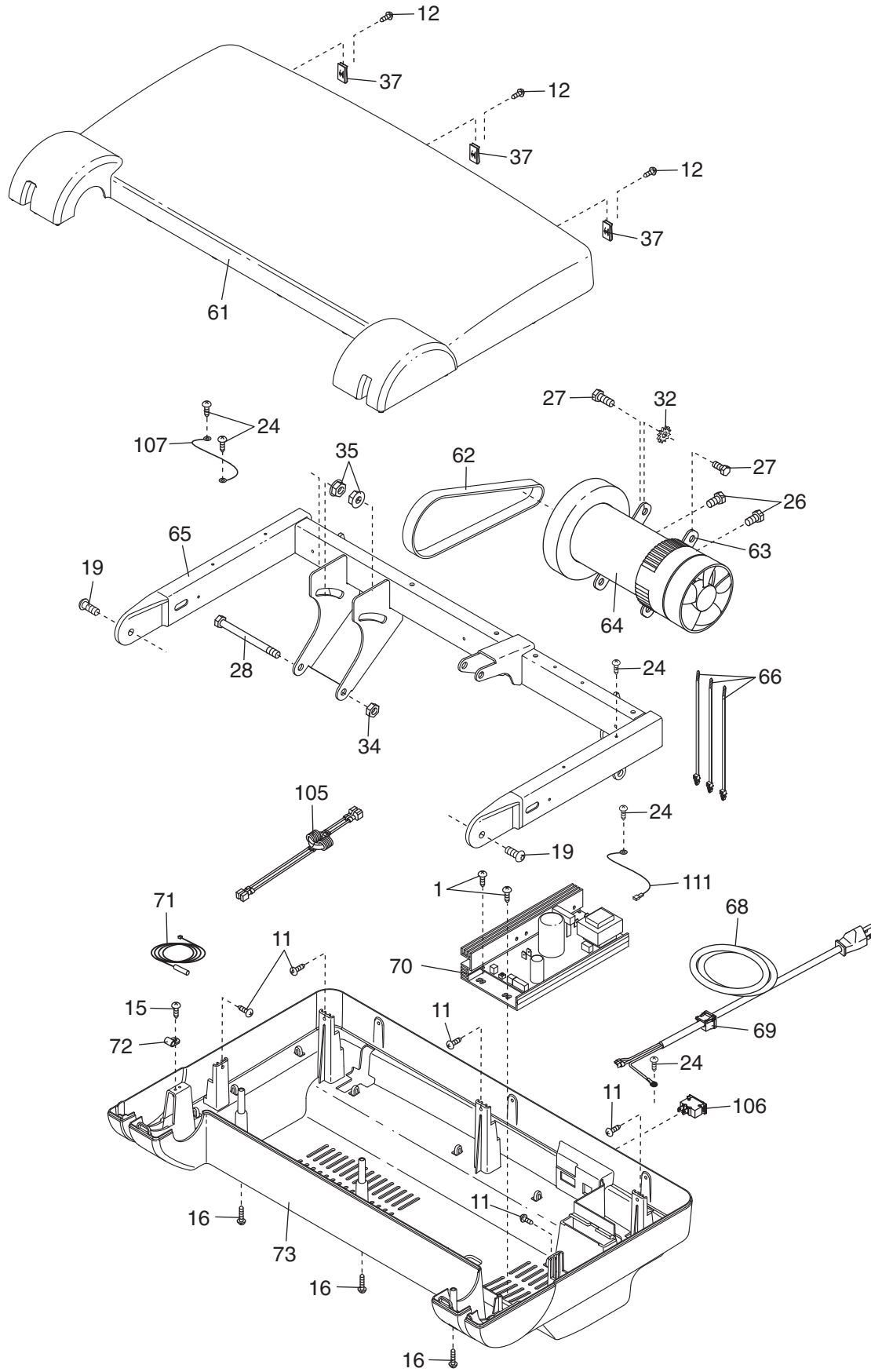

# EXPLODED DRAWING B—Model No. PFTL56507.0

R0308A



# EXPLODED DRAWING C—Model No. PFTL56507.0

R0308A

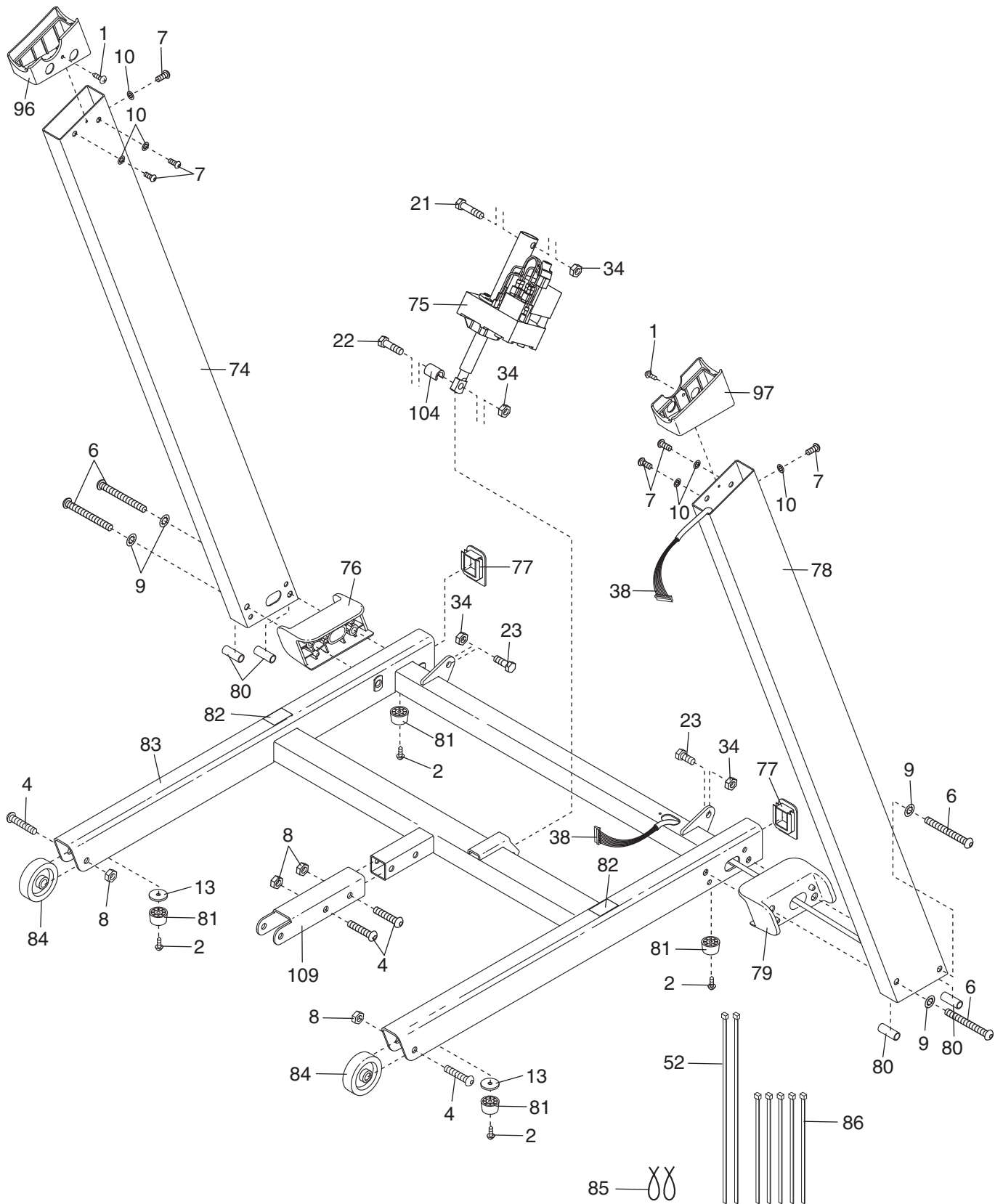

# EXPLODED DRAWING D—Model No. PFTL56507.0

R0308A

