

EXPLODED DRAWING A—Model No. PFTL56507.1

R0409A

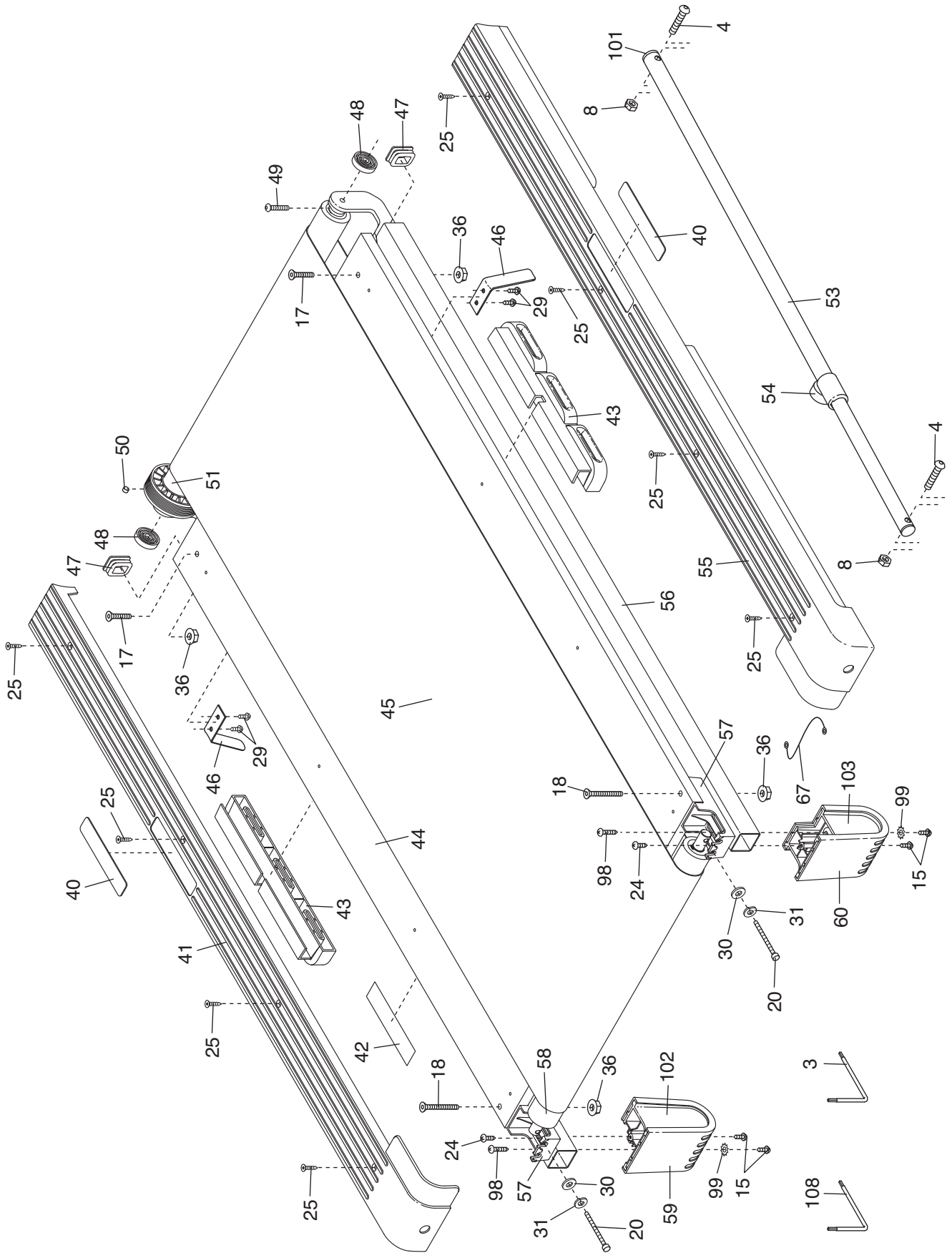

EXPLODED DRAWING B—Model No. PFTL56507.1

R0409A

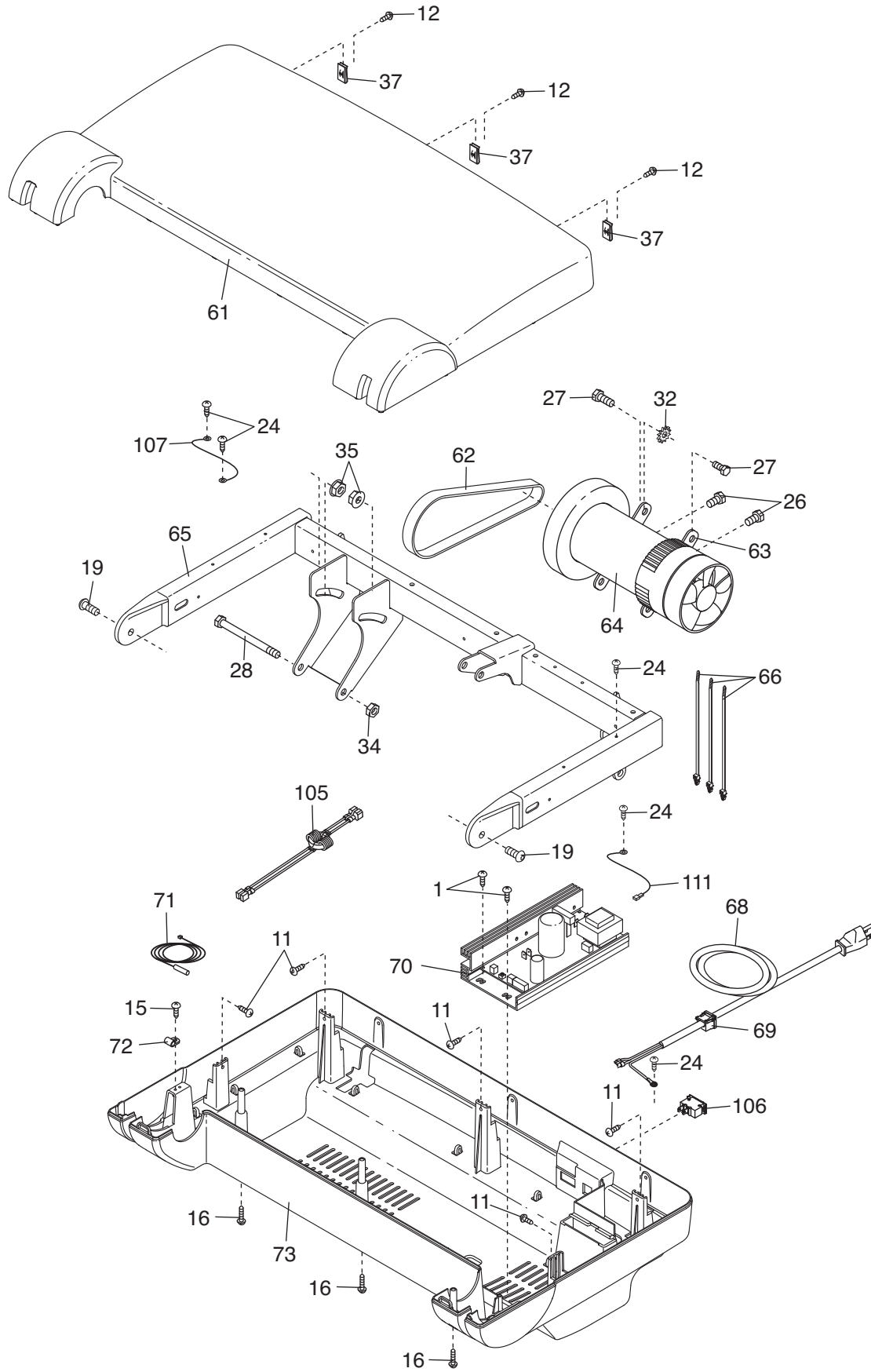

EXPLODED DRAWING C—Model No. PFTL56507.1

R0409A

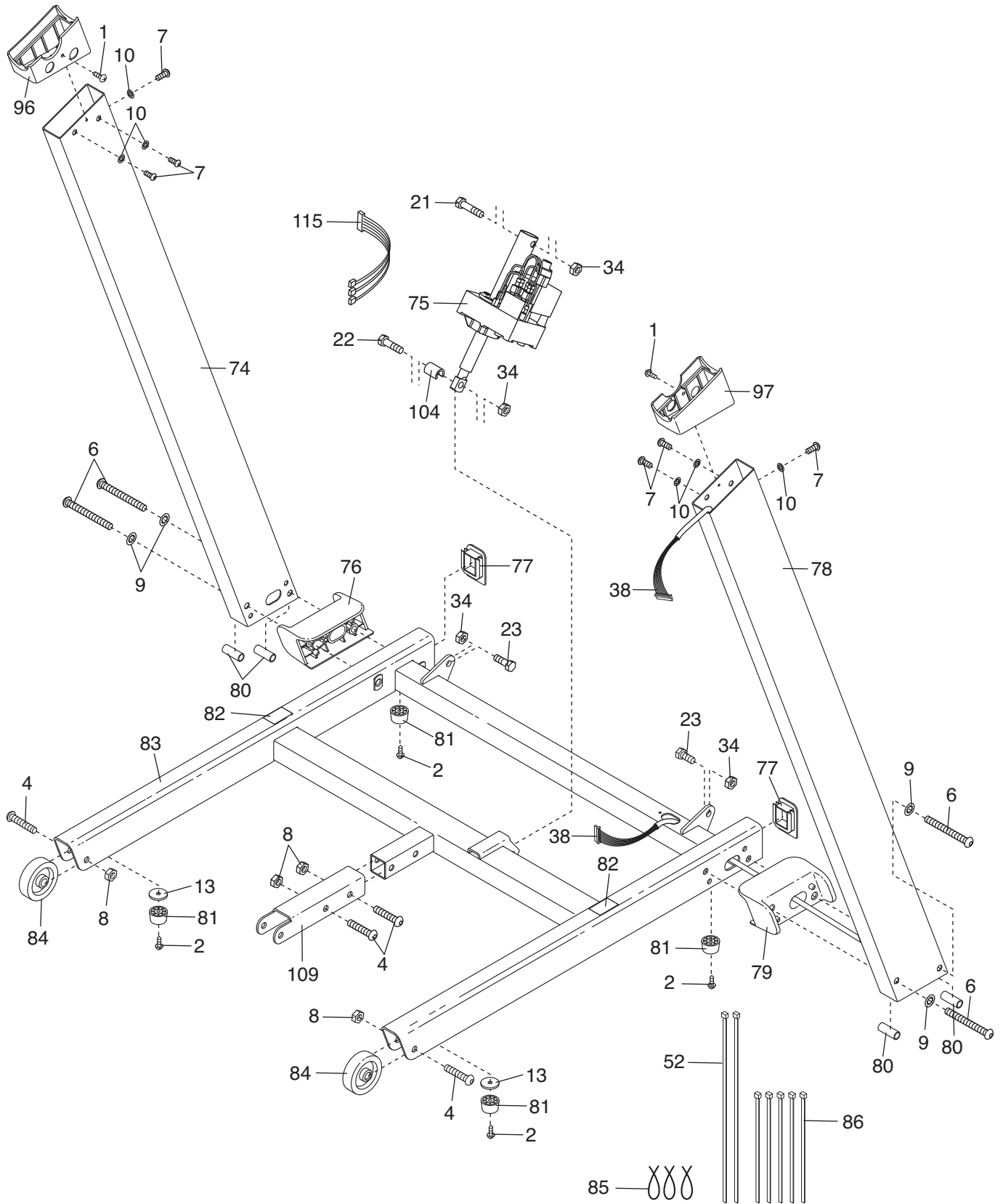

EXPLODED DRAWING D—Model No. PFTL56507.1

R0409A

