

EXPLODED DRAWING A—Model No. PFTL57706.0

R0807A

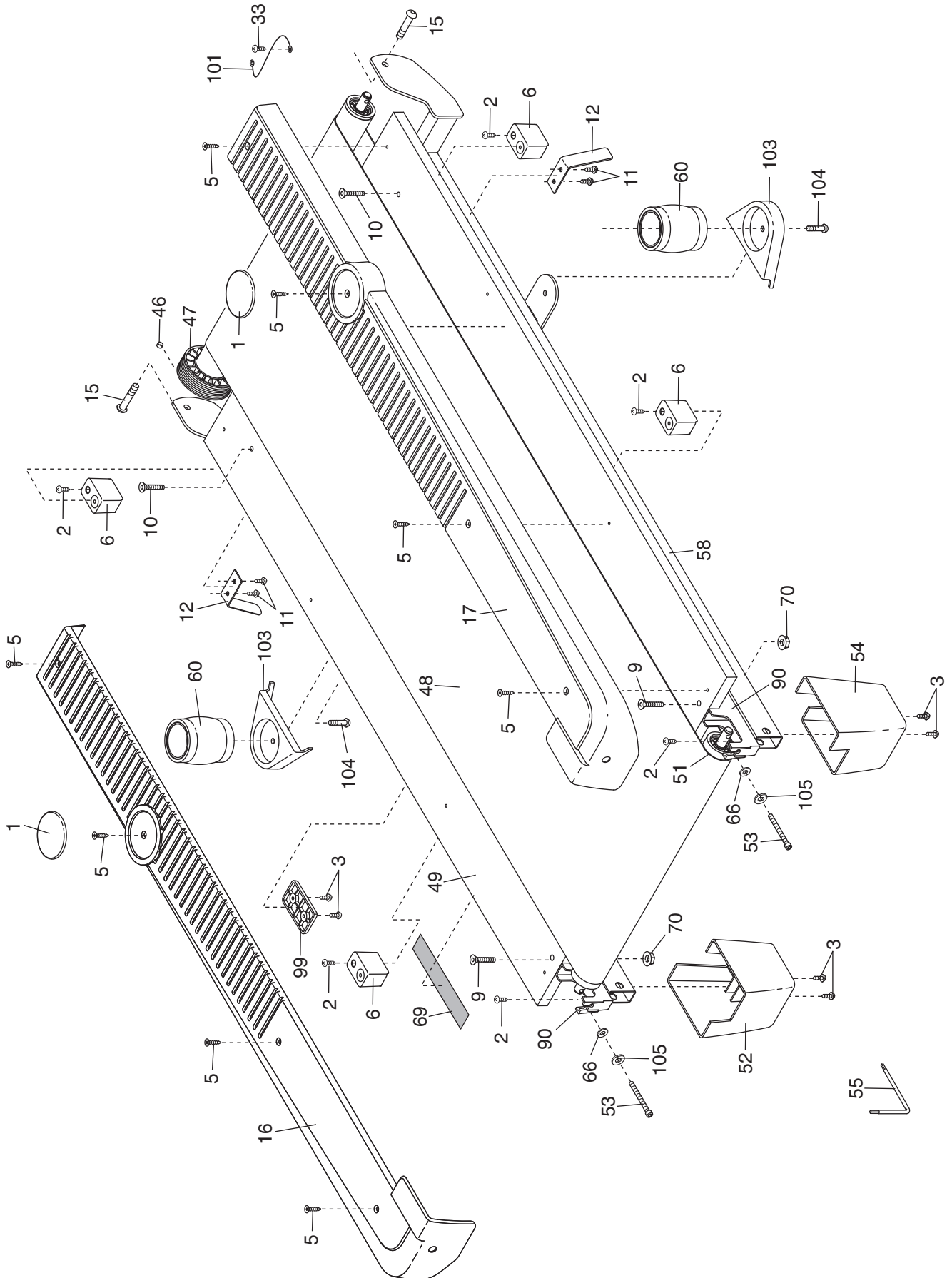

EXPLODED DRAWING B—Model No. PFTL57706.0

R0807A

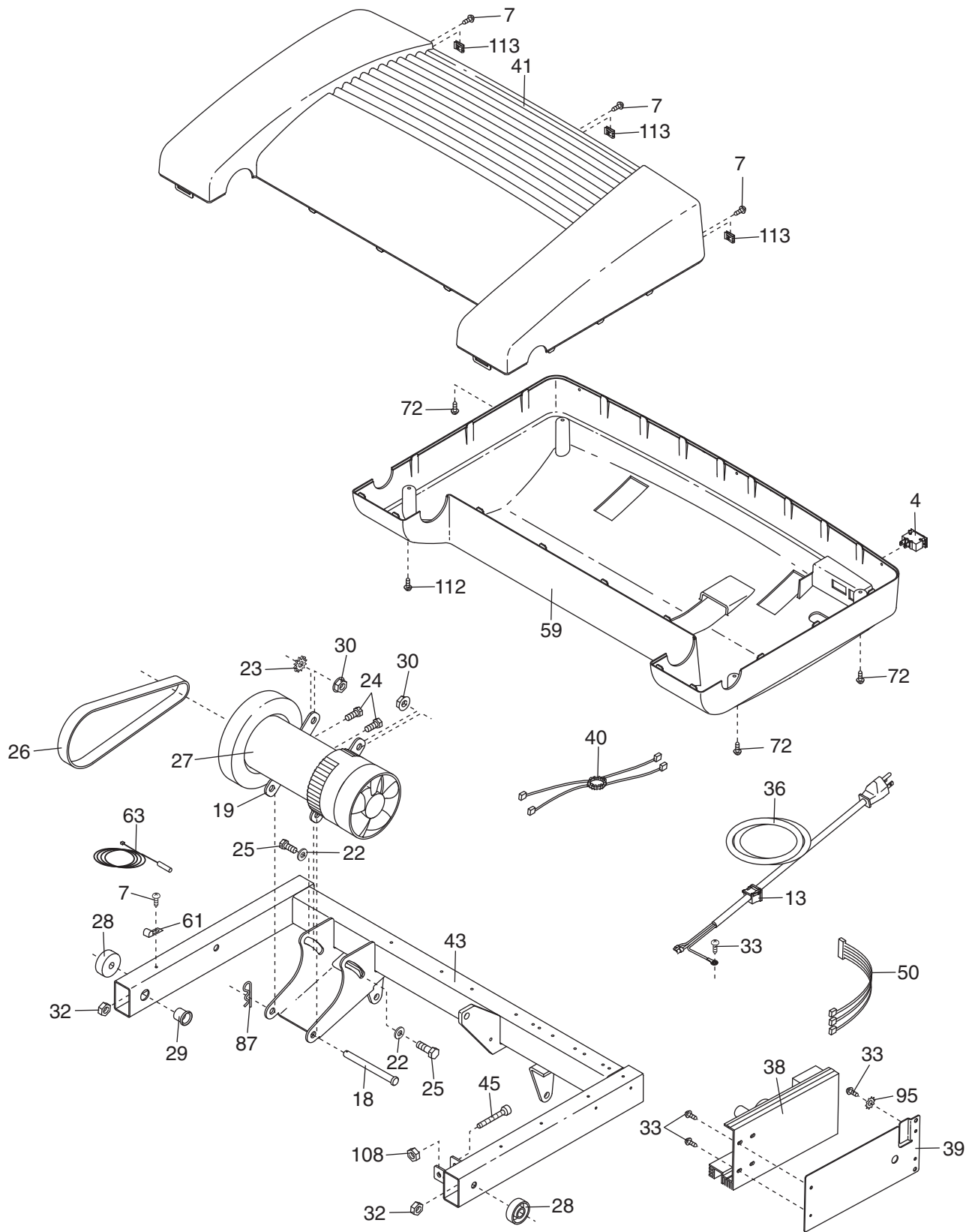

EXPLODED DRAWING C—Model No. PFTL57706.0

R0807A

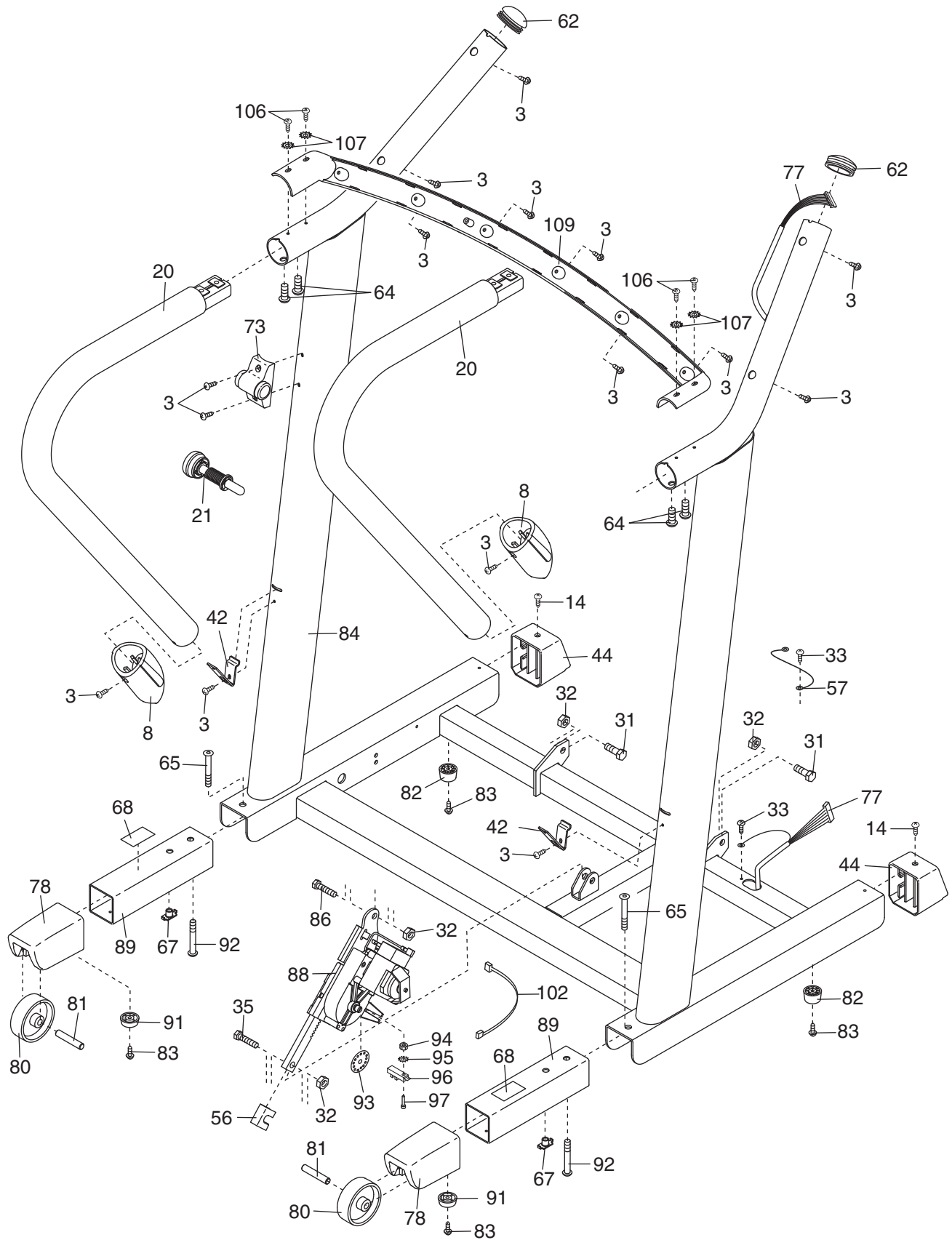

EXPLODED DRAWING D—Model No. PFTL57706.0

R0807A

