

# EXPLODED DRAWING A—Model No. PFTL57706.1

R0508A

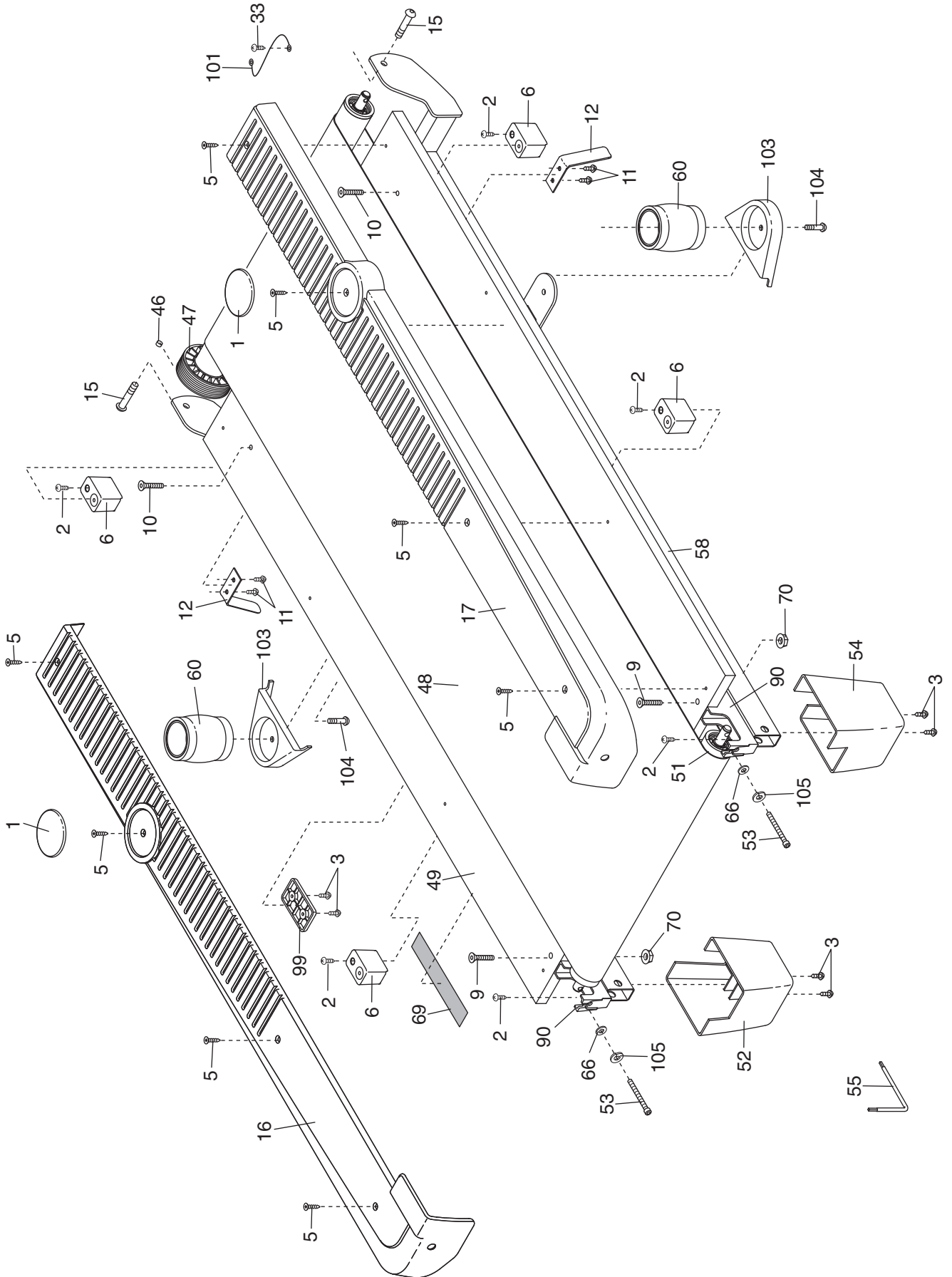

# EXPLODED DRAWING B—Model No. PFTL57706.1

R0508A

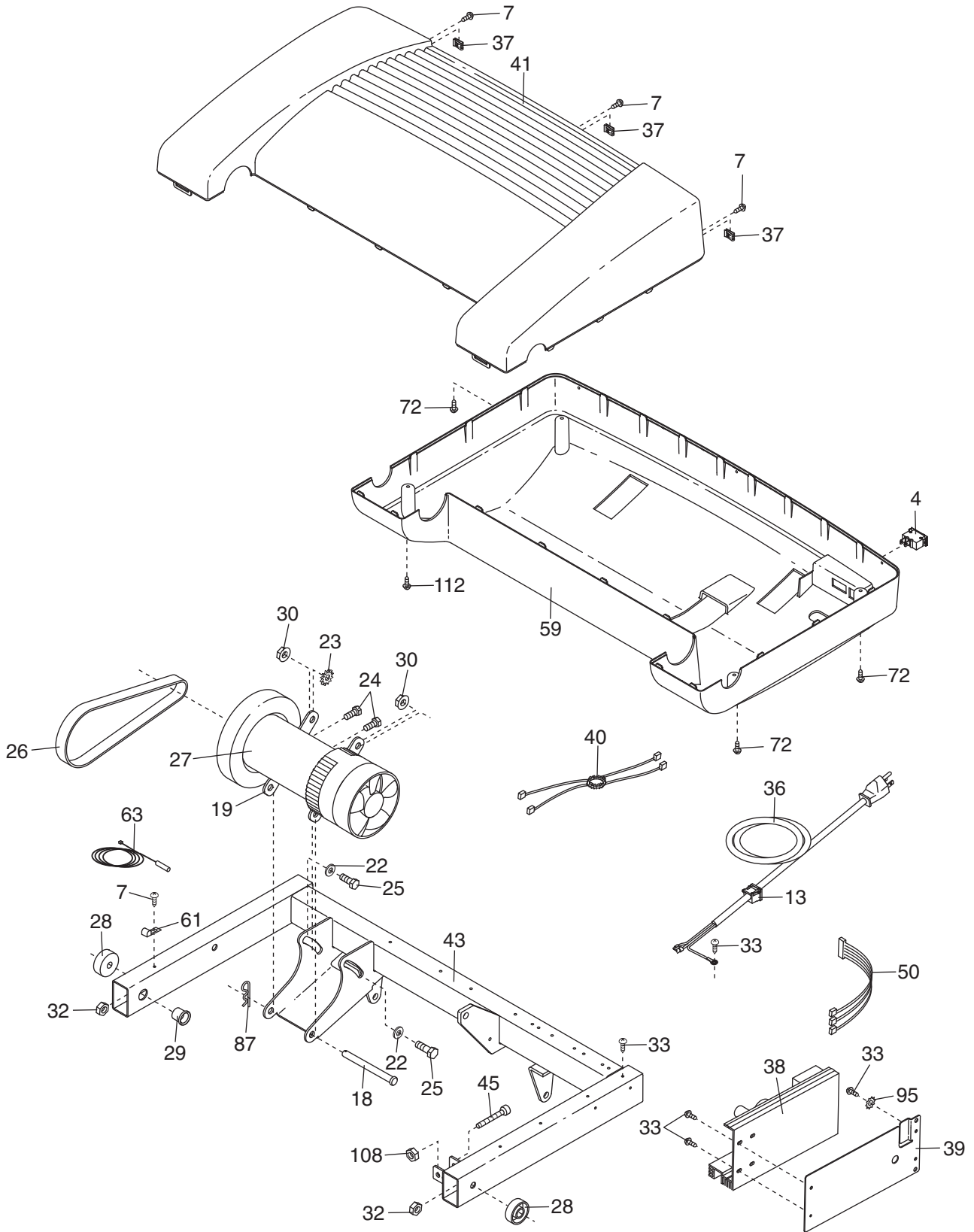

# EXPLODED DRAWING C—Model No. PFTL57706.1

R0508A

