

EXPLODED DRAWING A—Model No. PFTL57809.0

R1109A

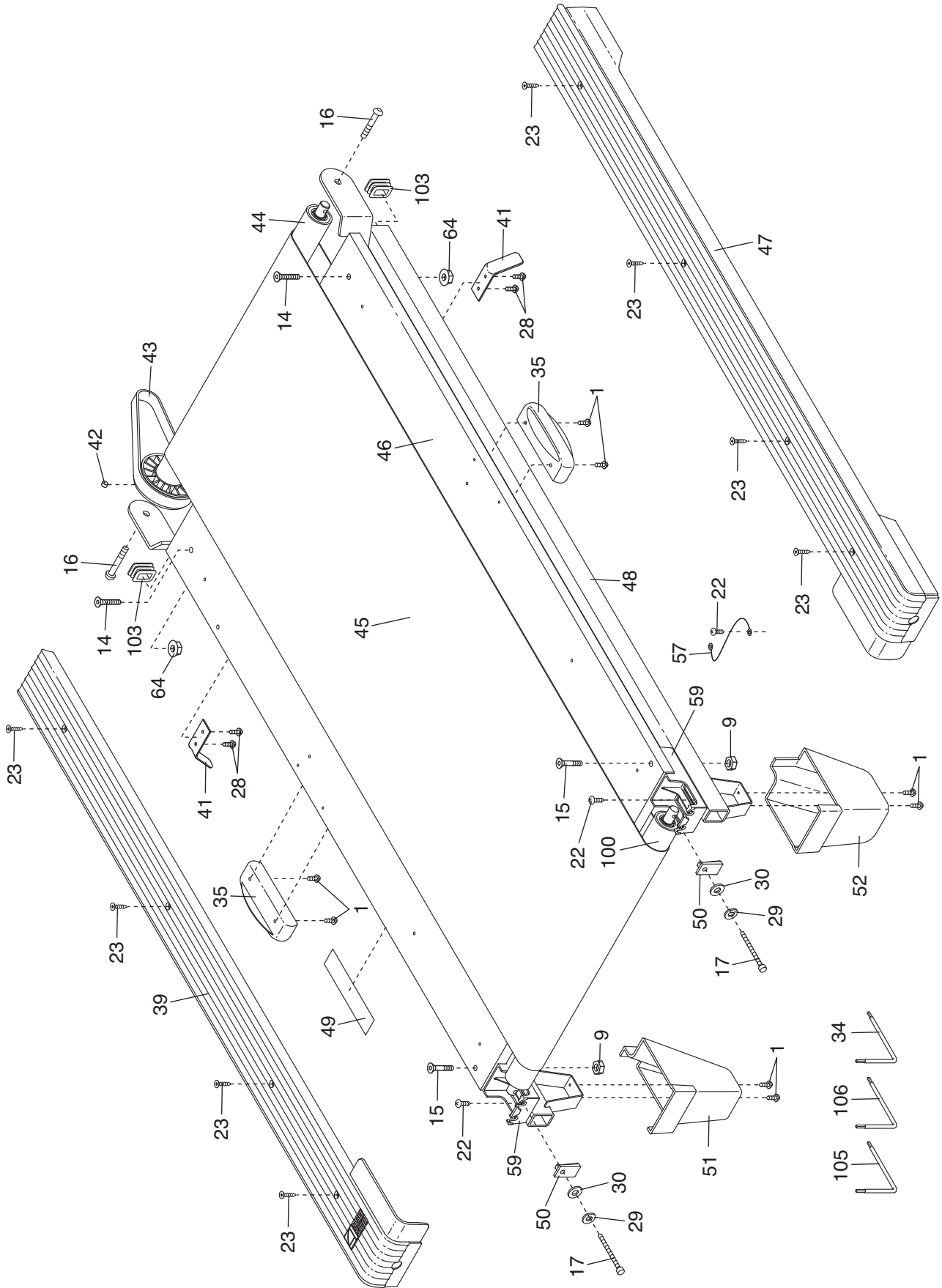

EXPLODED DRAWING B—Model No. PFTL57809.0

R1109A

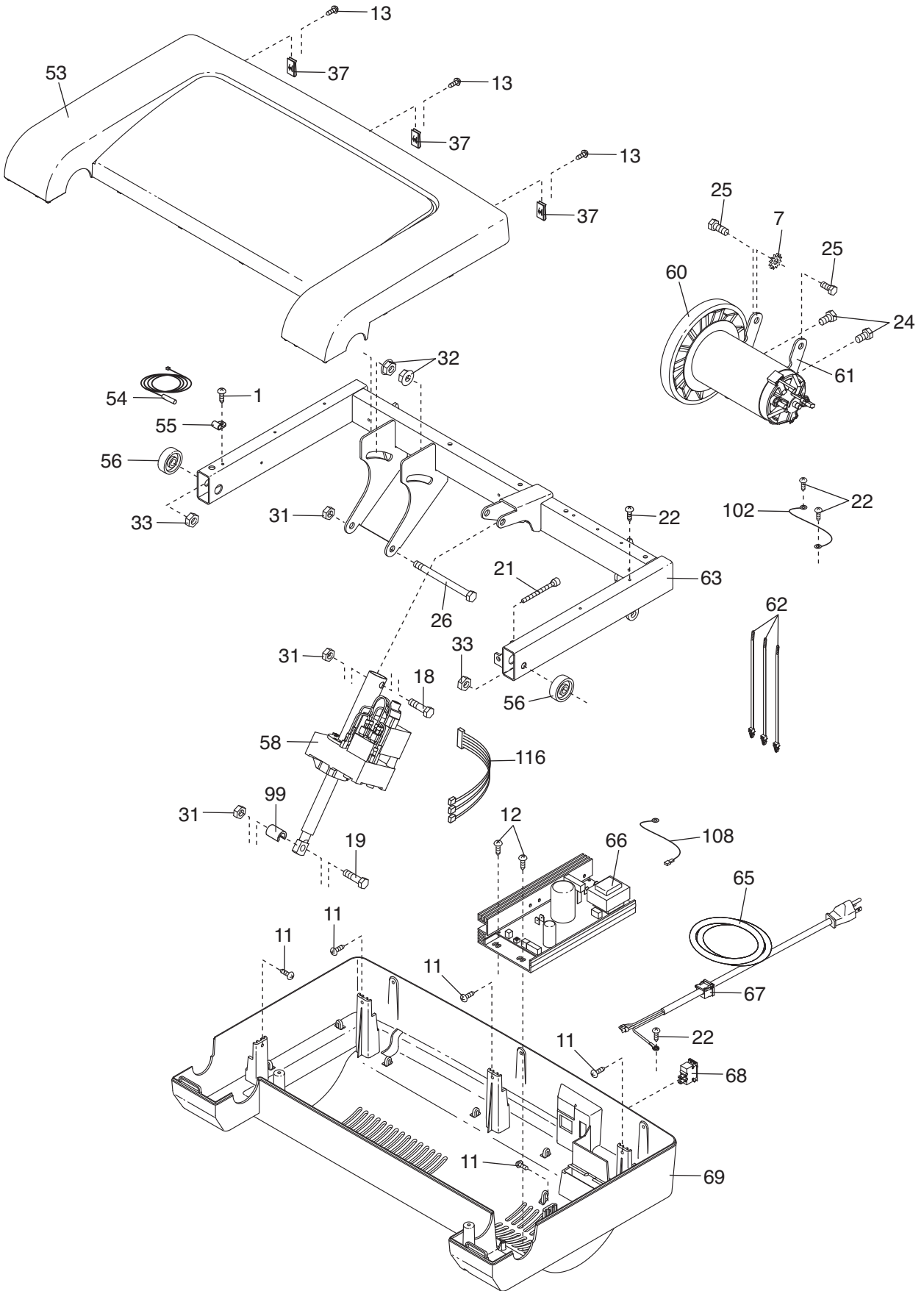

EXPLODED DRAWING C—Model No. PFTL57809.0

R1109A

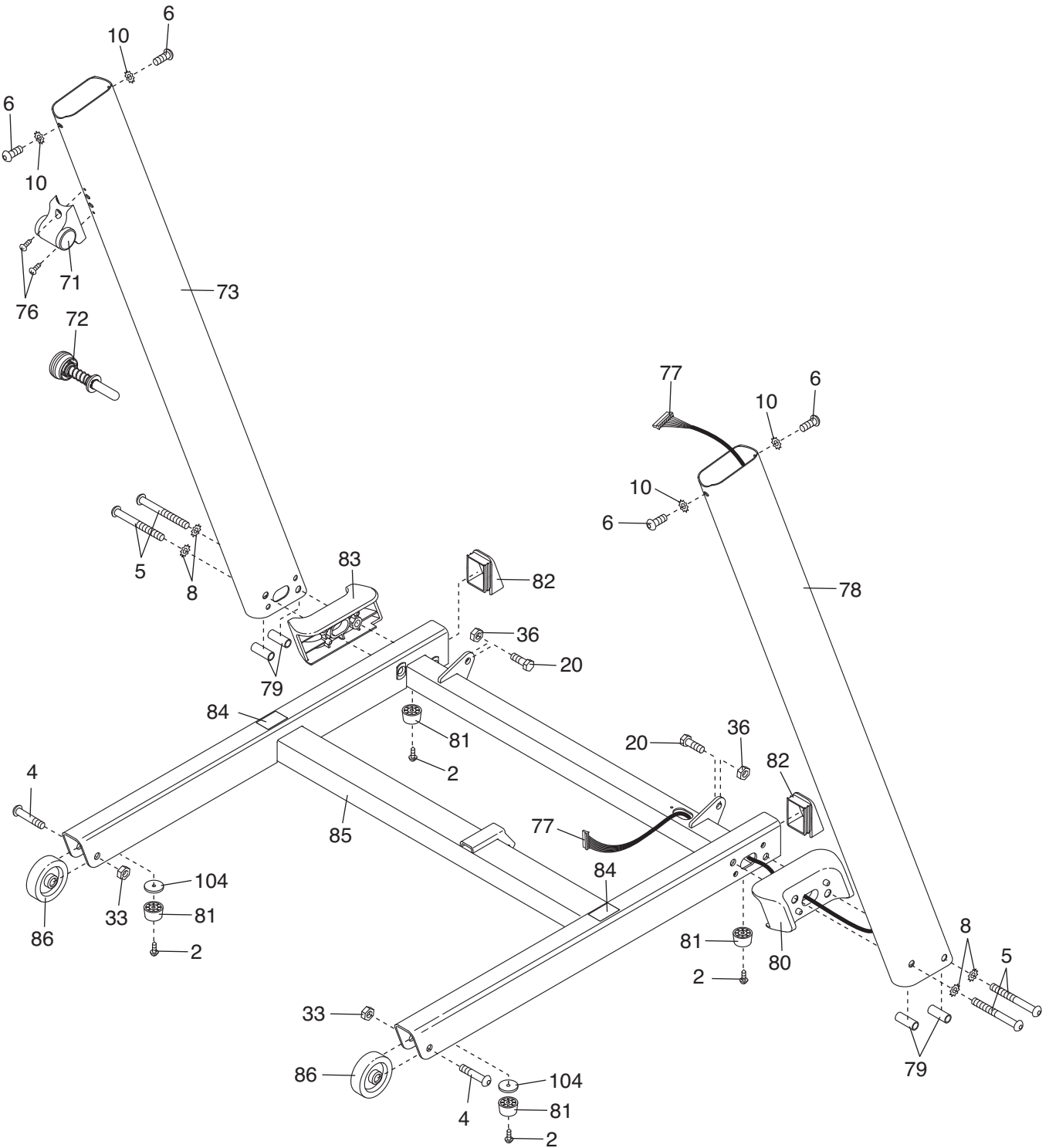

EXPLODED DRAWING D—Model No. PFTL57809.0

R1109A

