

EXPLODED DRAWING A—Model No. PFTL57908.2

R0709A

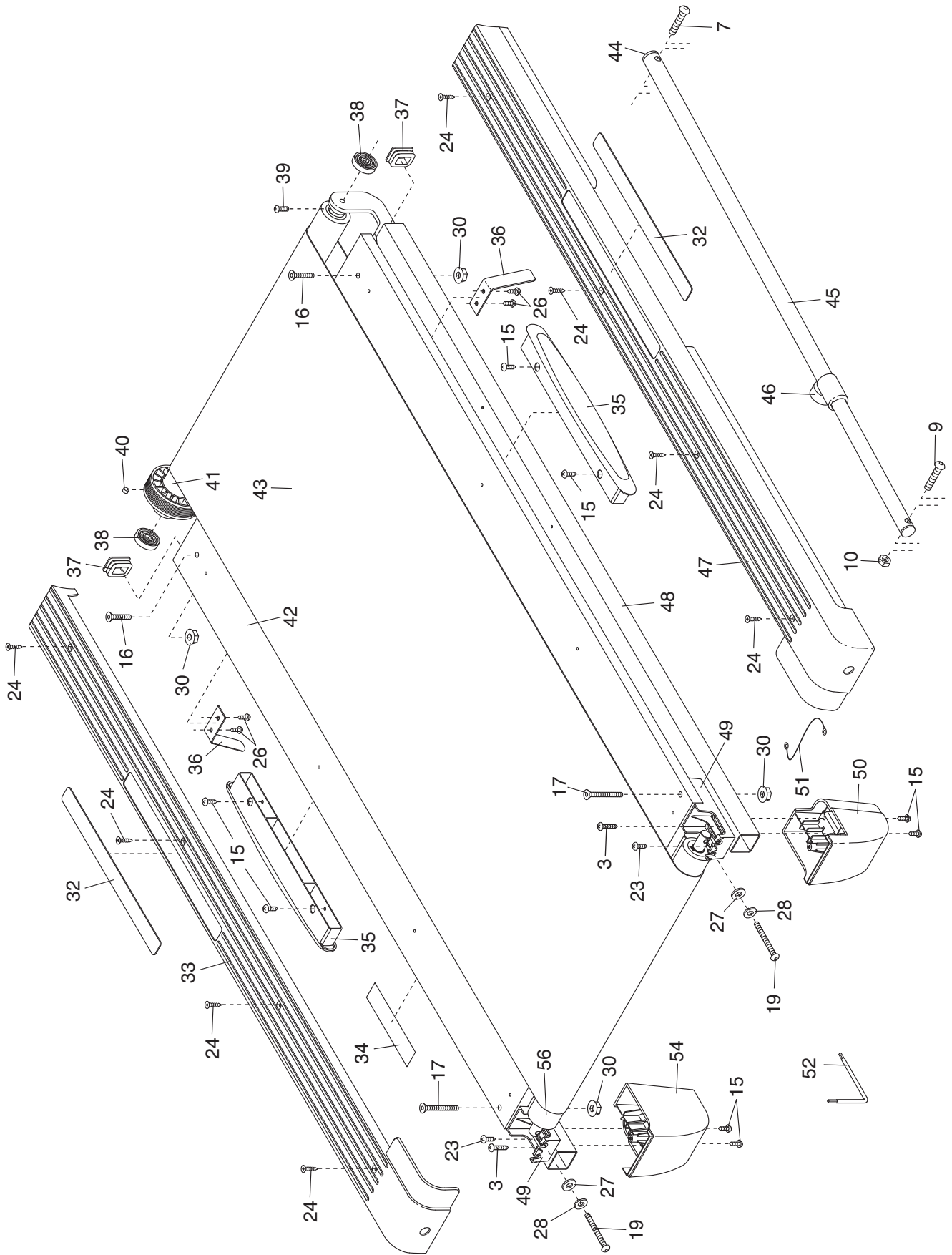

EXPLODED DRAWING B—Model No. PFTL57908.2

R0709A

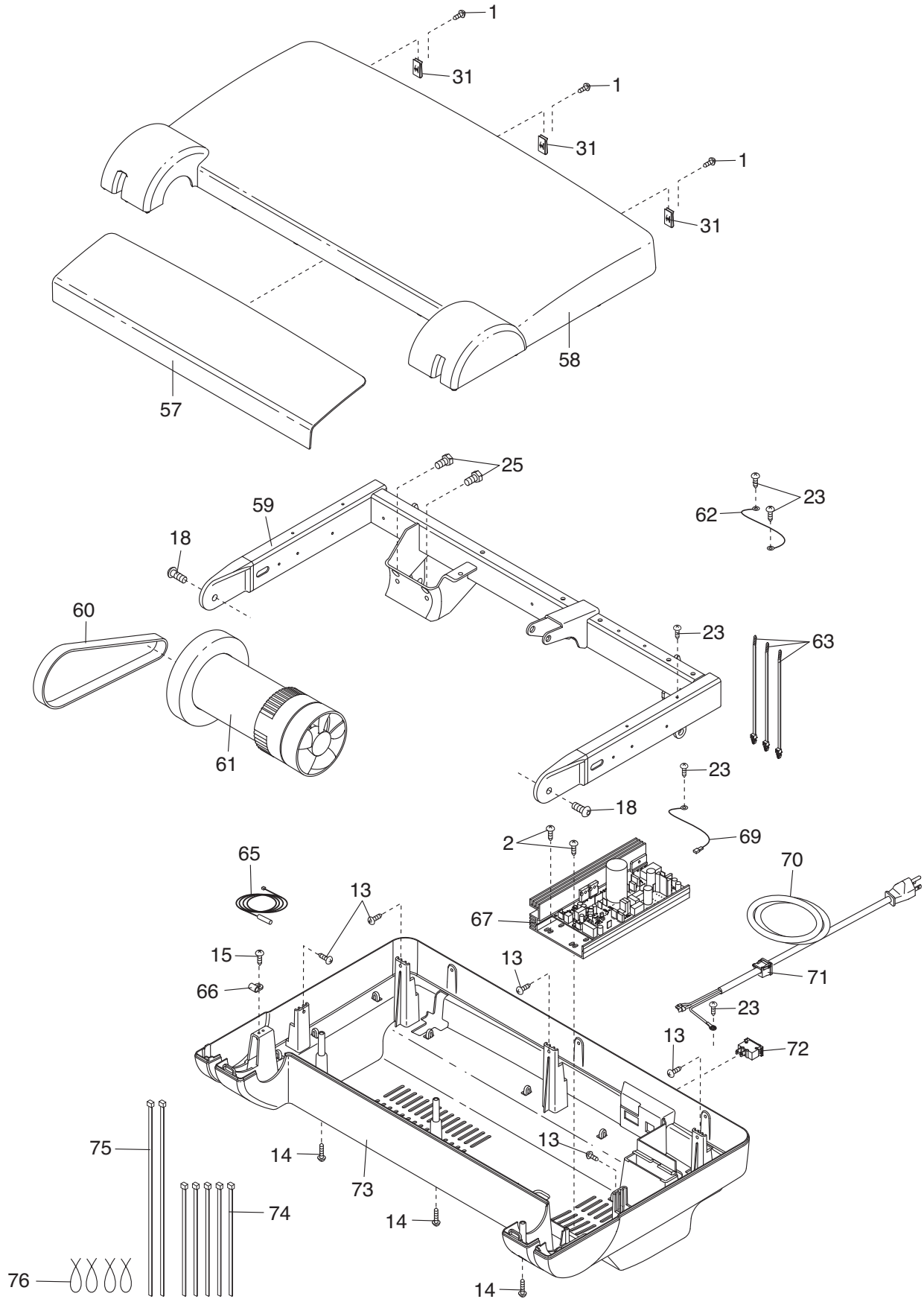

EXPLODED DRAWING C—Model No. PFTL57908.2

R0709A

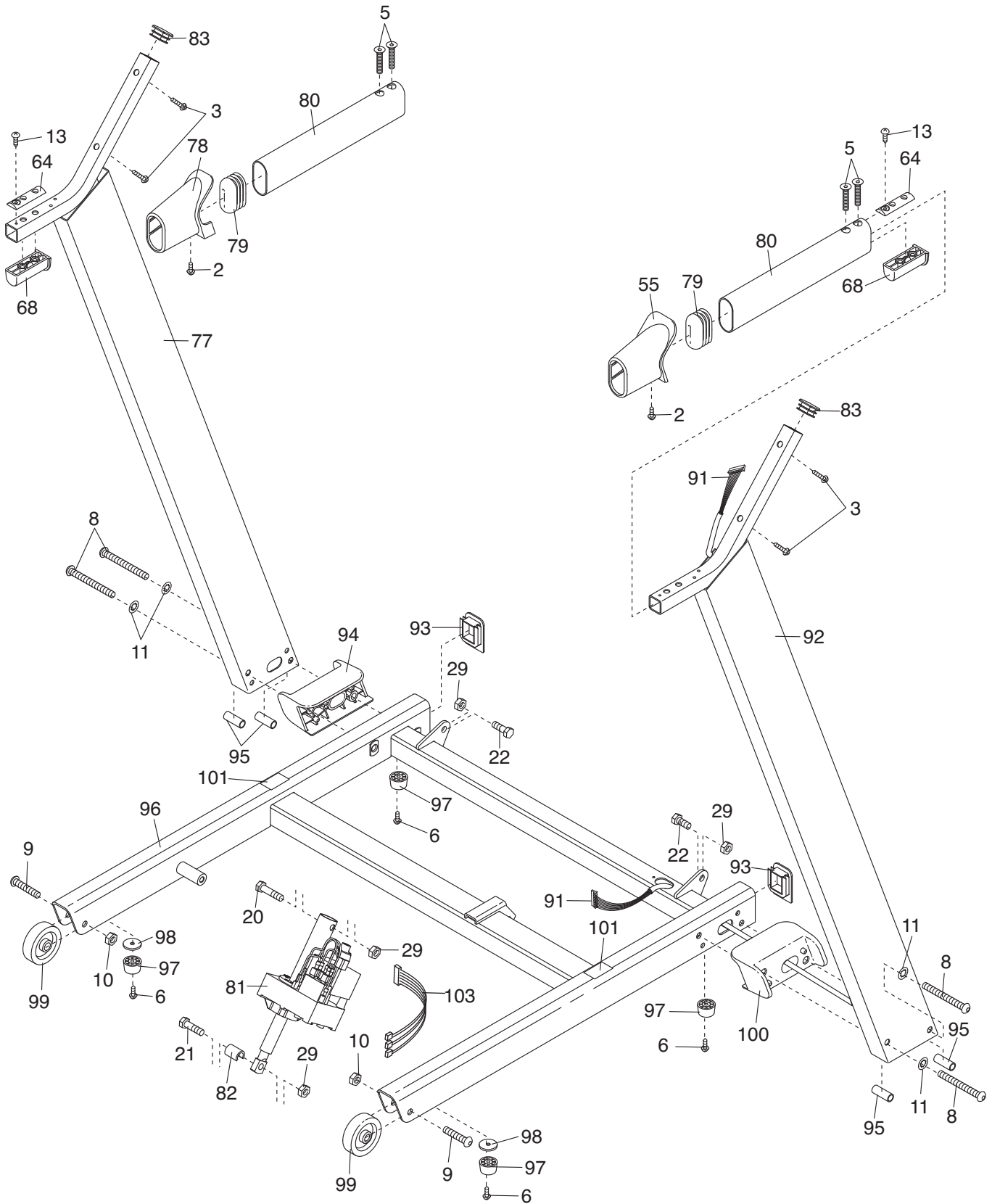

EXPLODED DRAWING D—Model No. PFTL57908.2

R0709A

