

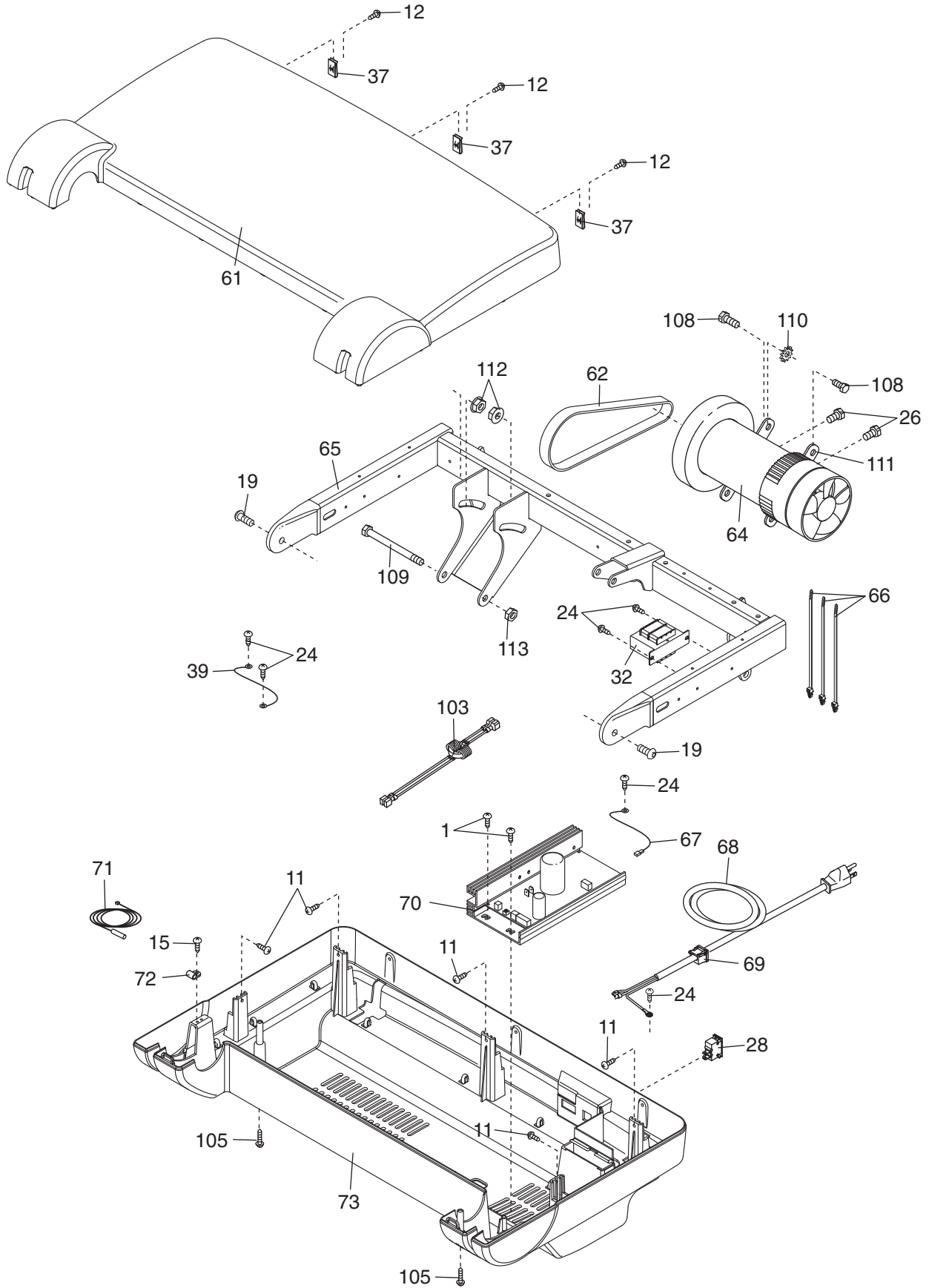

# EXPLODED DRAWING B—Model No. PFTL58007.1

R1107A



# EXPLODED DRAWING C—Model No. PFTL58007.1

R1107A

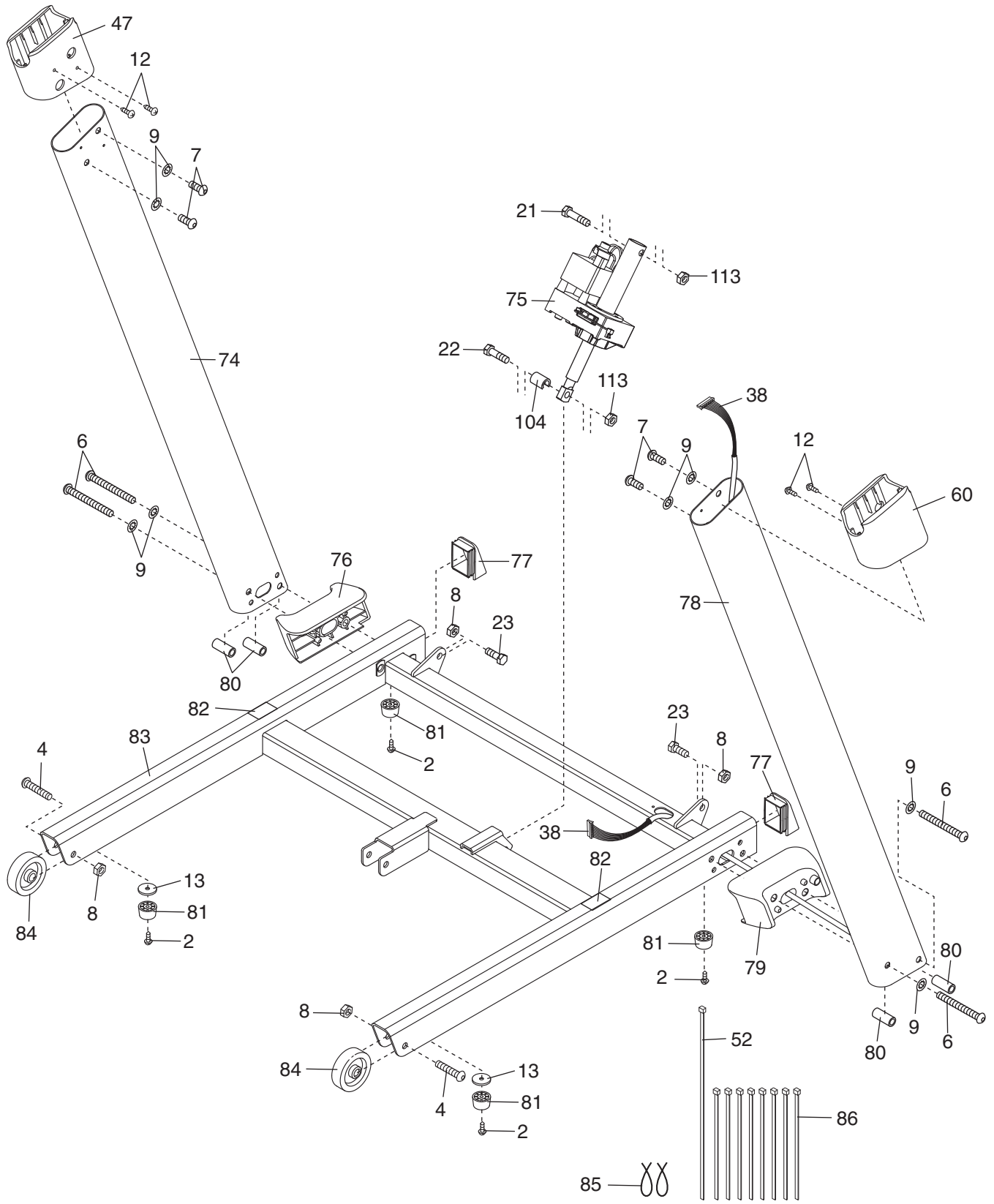

# EXPLODED DRAWING D—Model No. PFTL58007.1

R1107A

