

EXPLODED DRAWING B—Model No. PFTL59007.0

R0707A

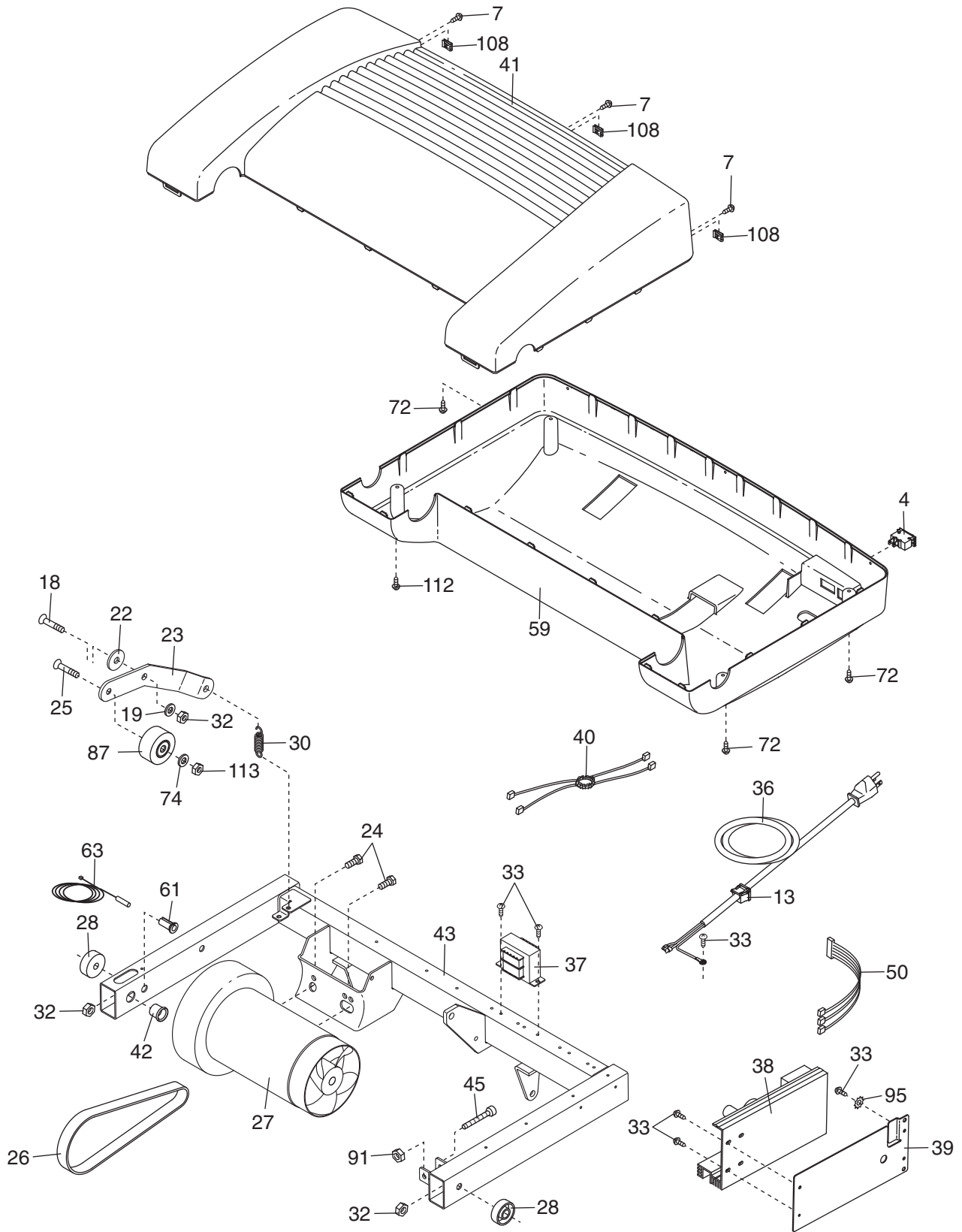

EXPLODED DRAWING D—Model No. PFTL59007.0

R0707A

