

EXPLODED DRAWING A—Model No. PFTL59009.0

R1009A

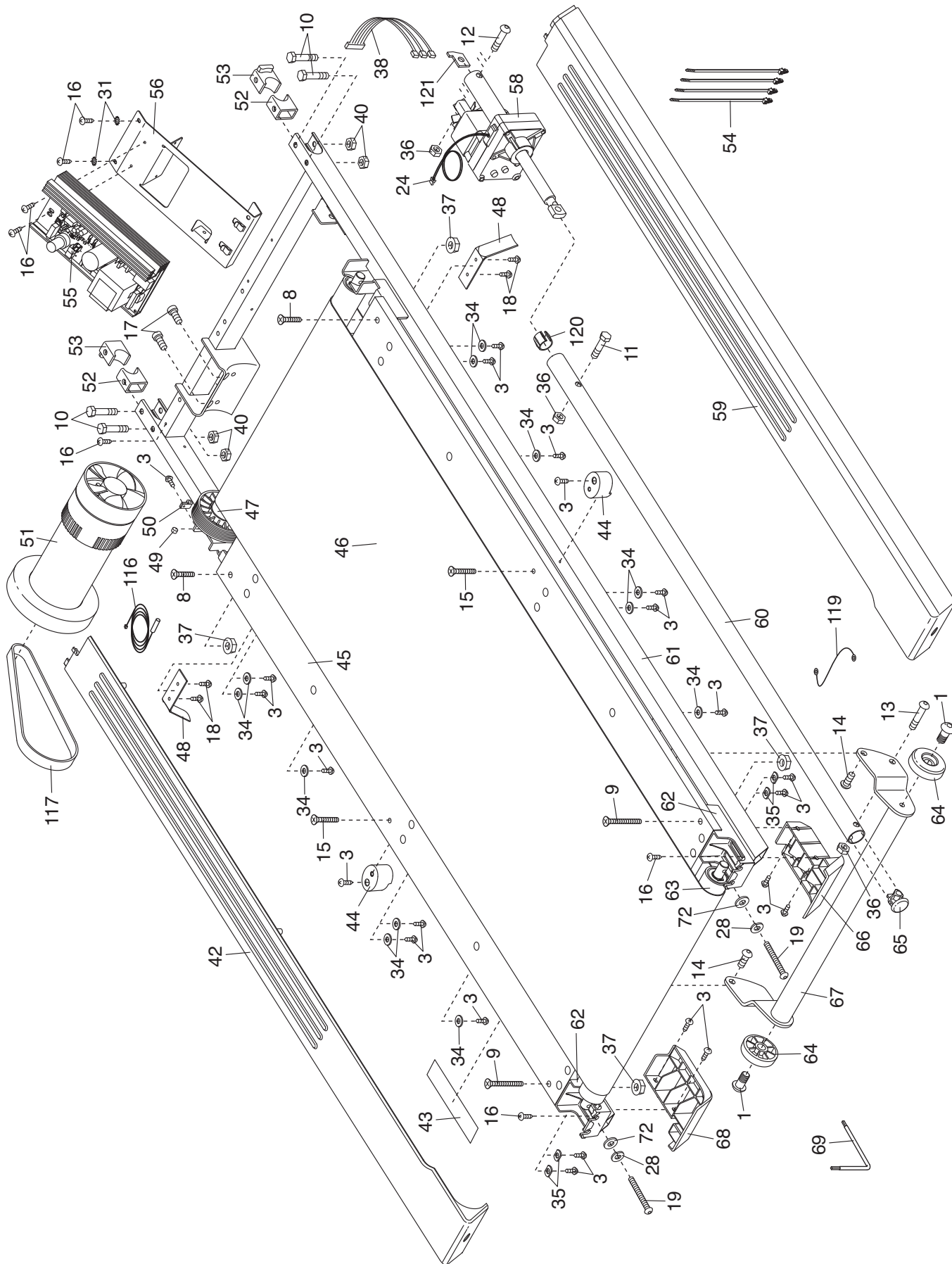

EXPLODED DRAWING B—Model No. PFTL59009.0

R1009A

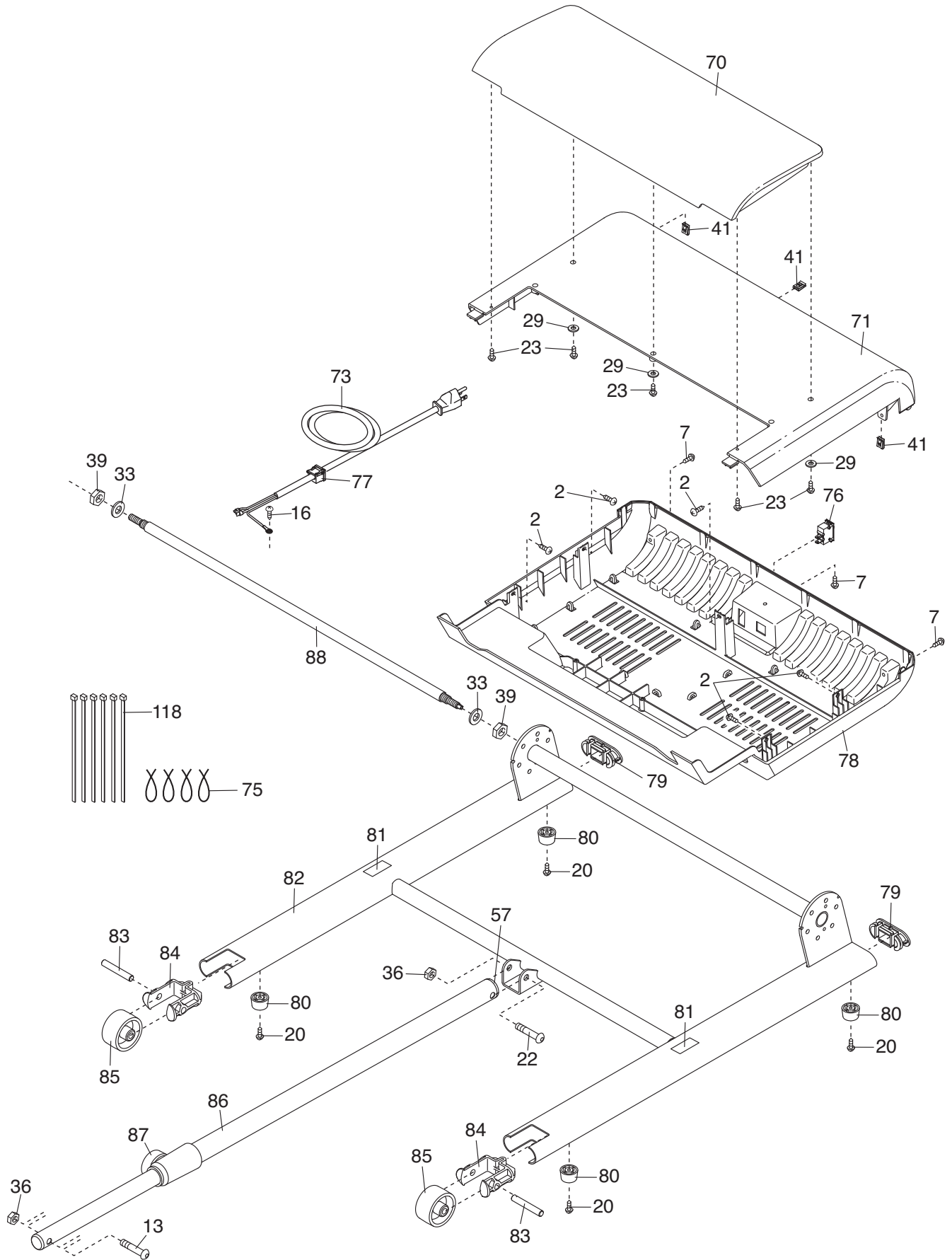

EXPLODED DRAWING C—Model No. PFTL59009.0

R1009A

