

EXPLODED DRAWING B

Model No. PFTL59010.0 R0113A

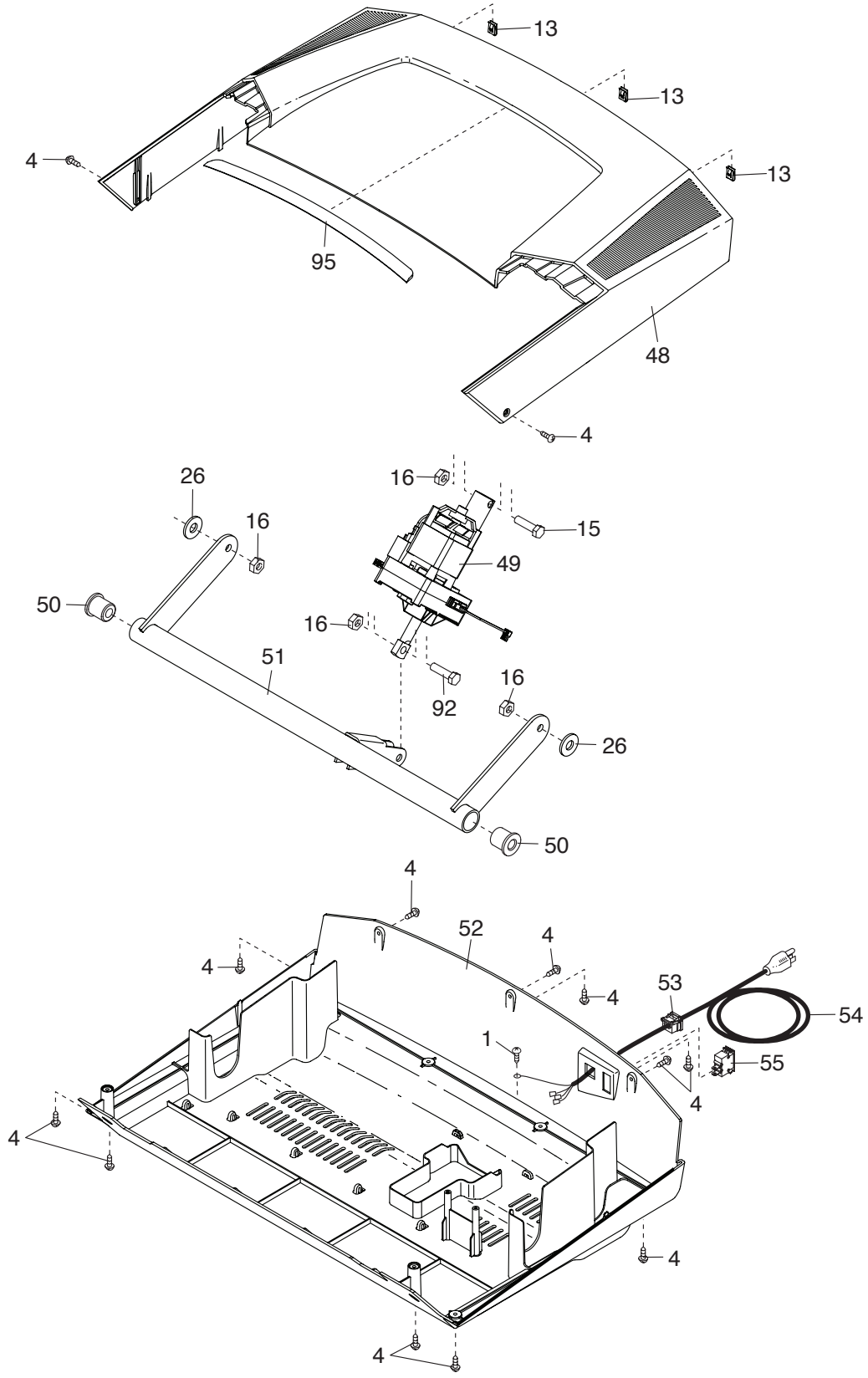

EXPLODED DRAWING C

Model No. PFTL59010.0 R0113A

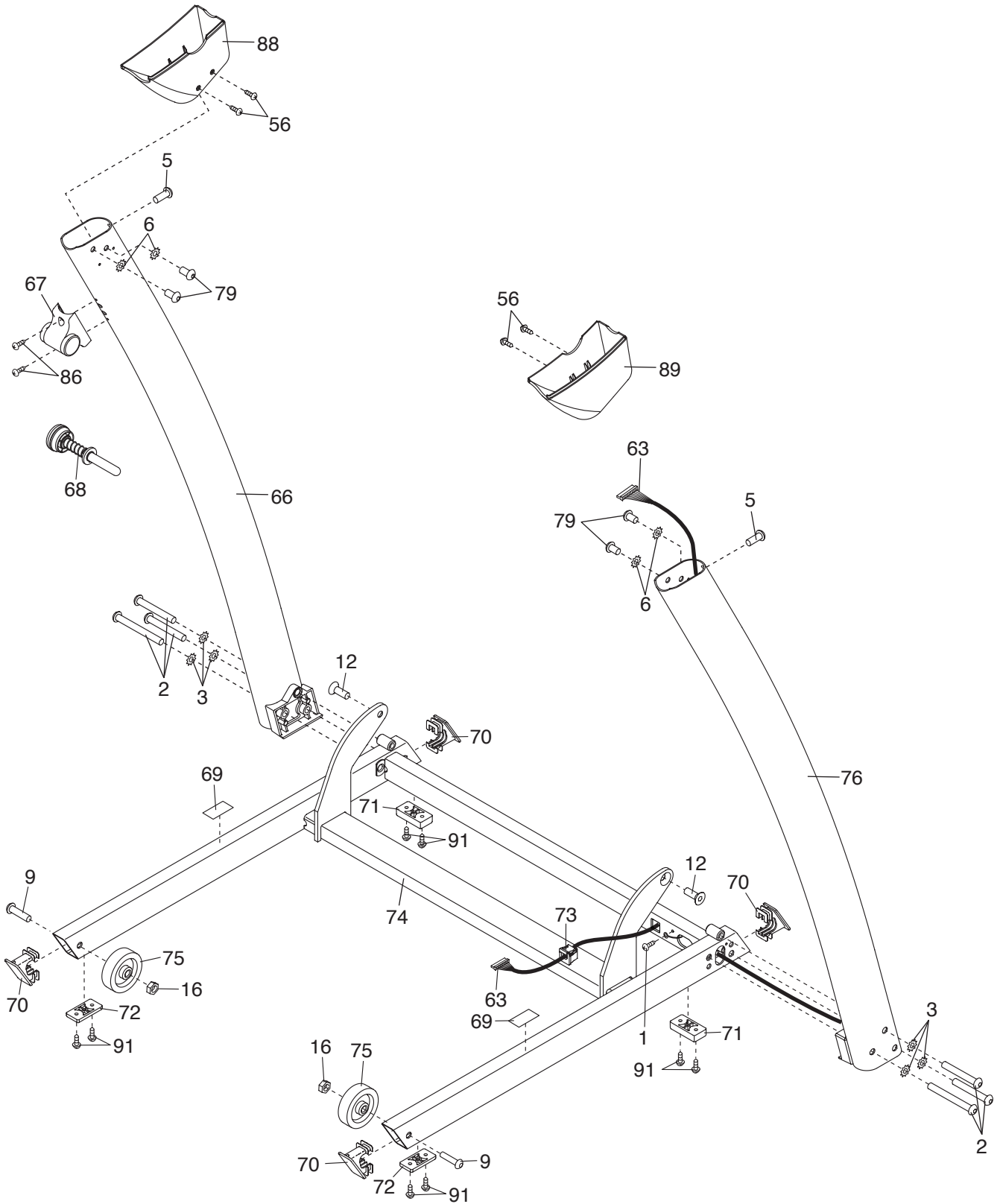

EXPLODED DRAWING D

Model No. PFTL59010.0 R0113A

