

# EXPLODED DRAWING A

Model No. PFTL59010.1 R0914A

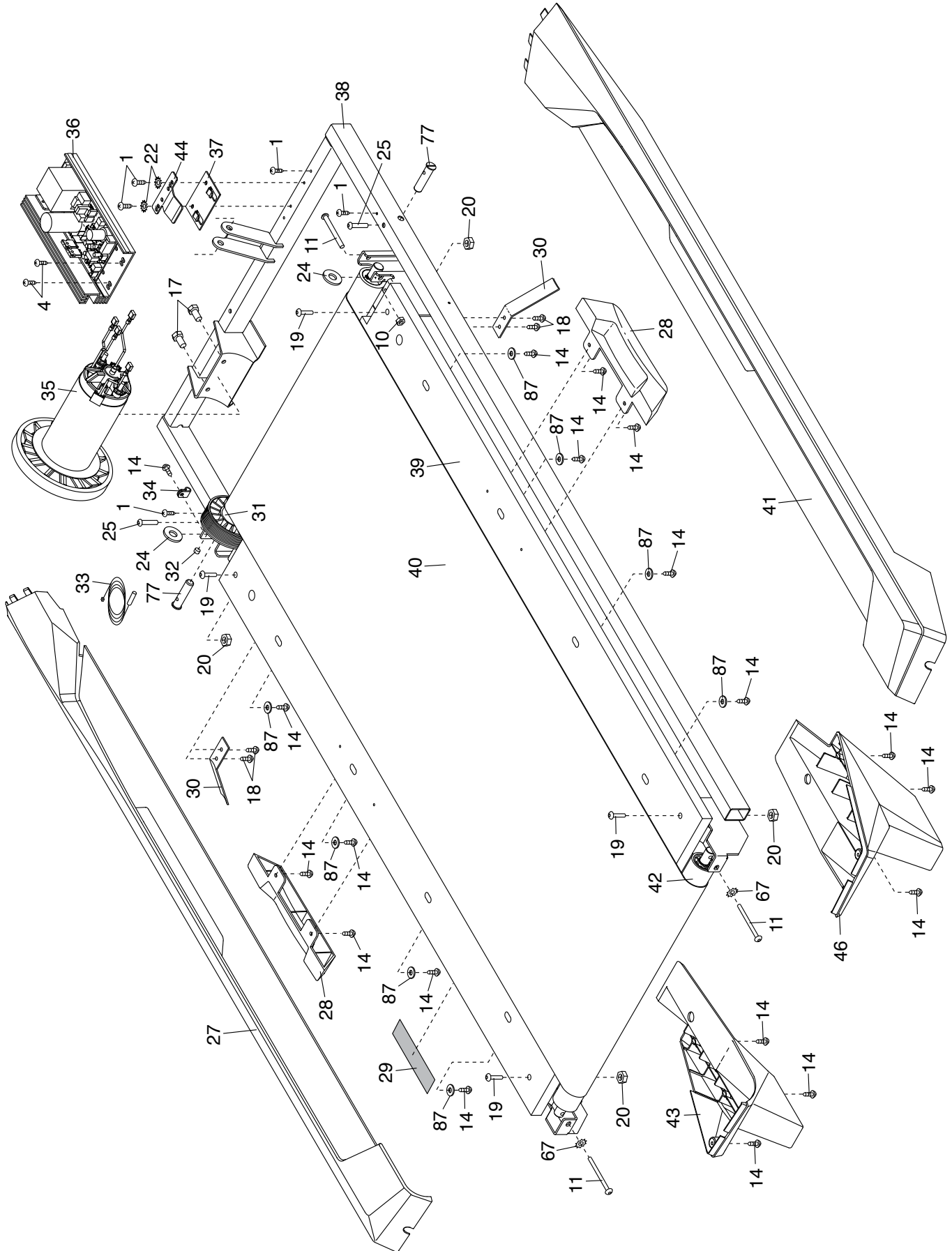

# EXPLODED DRAWING B

Model No. PFTL59010.1 R0914A

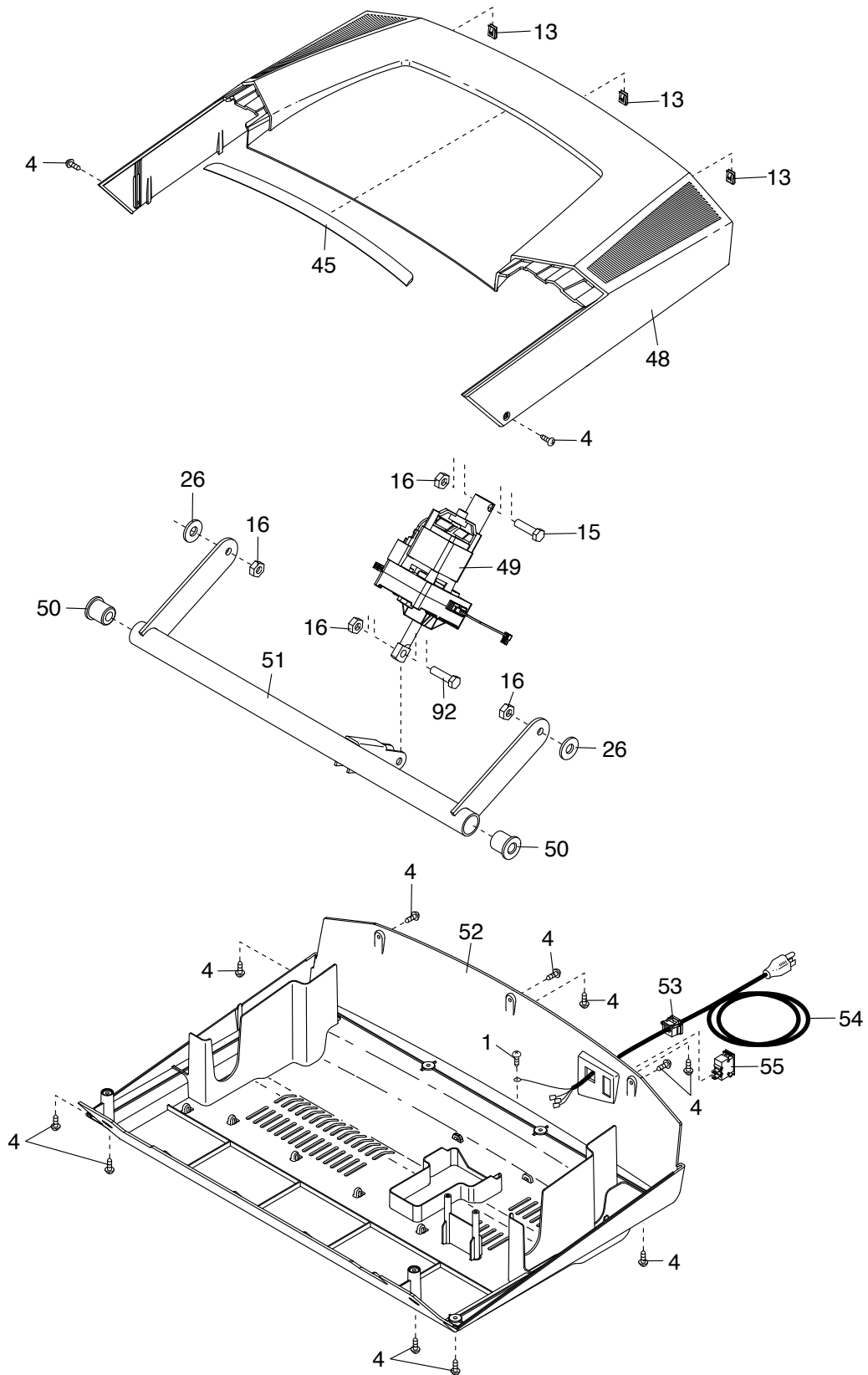



# EXPLODED DRAWING D

Model No. PFTL59010.1 R0914A

