

# EXPLODED DRAWING A

Model No. PFTL59011.0 R0512A

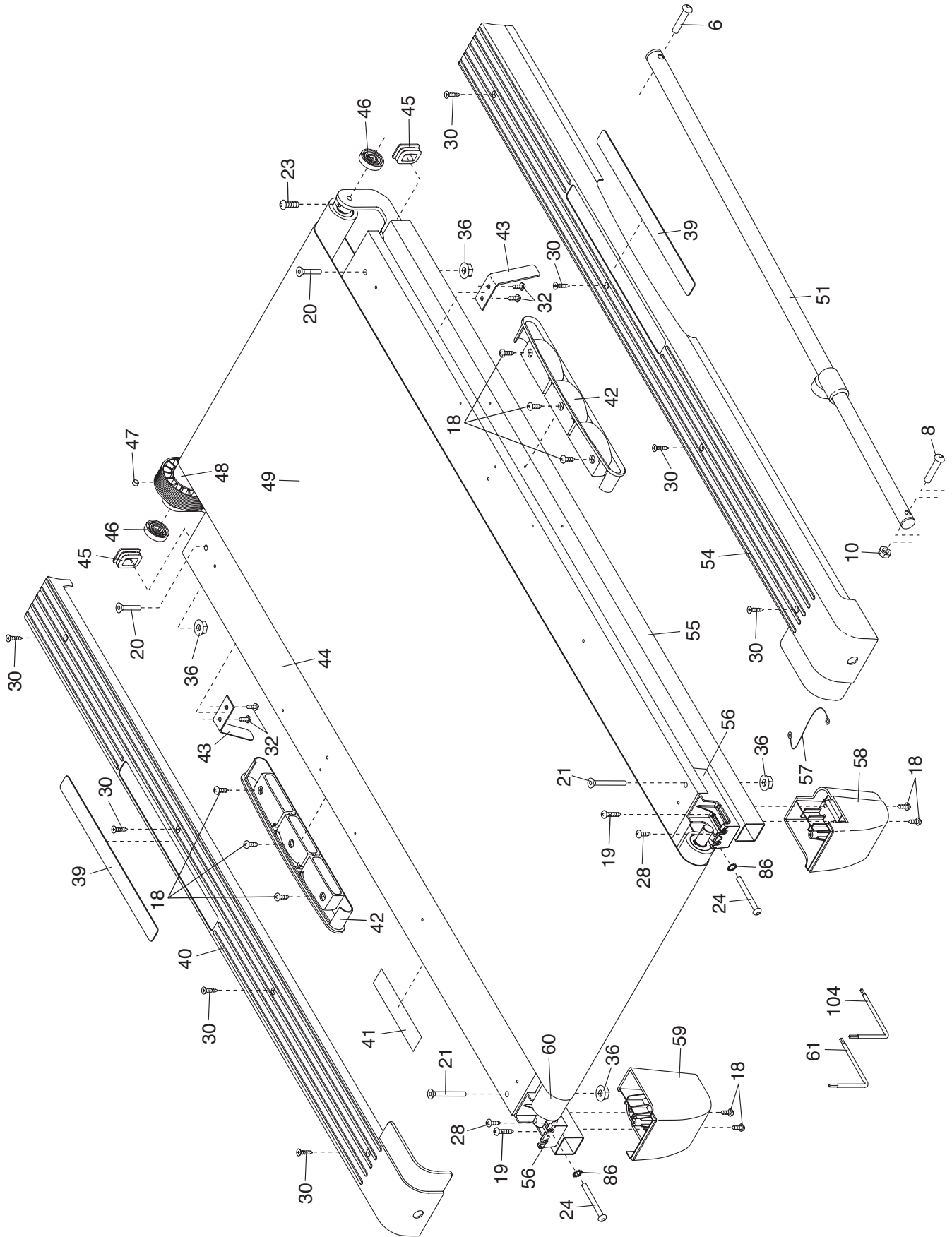

# EXPLODED DRAWING B

Model No. PFTL59011.0 R0512A

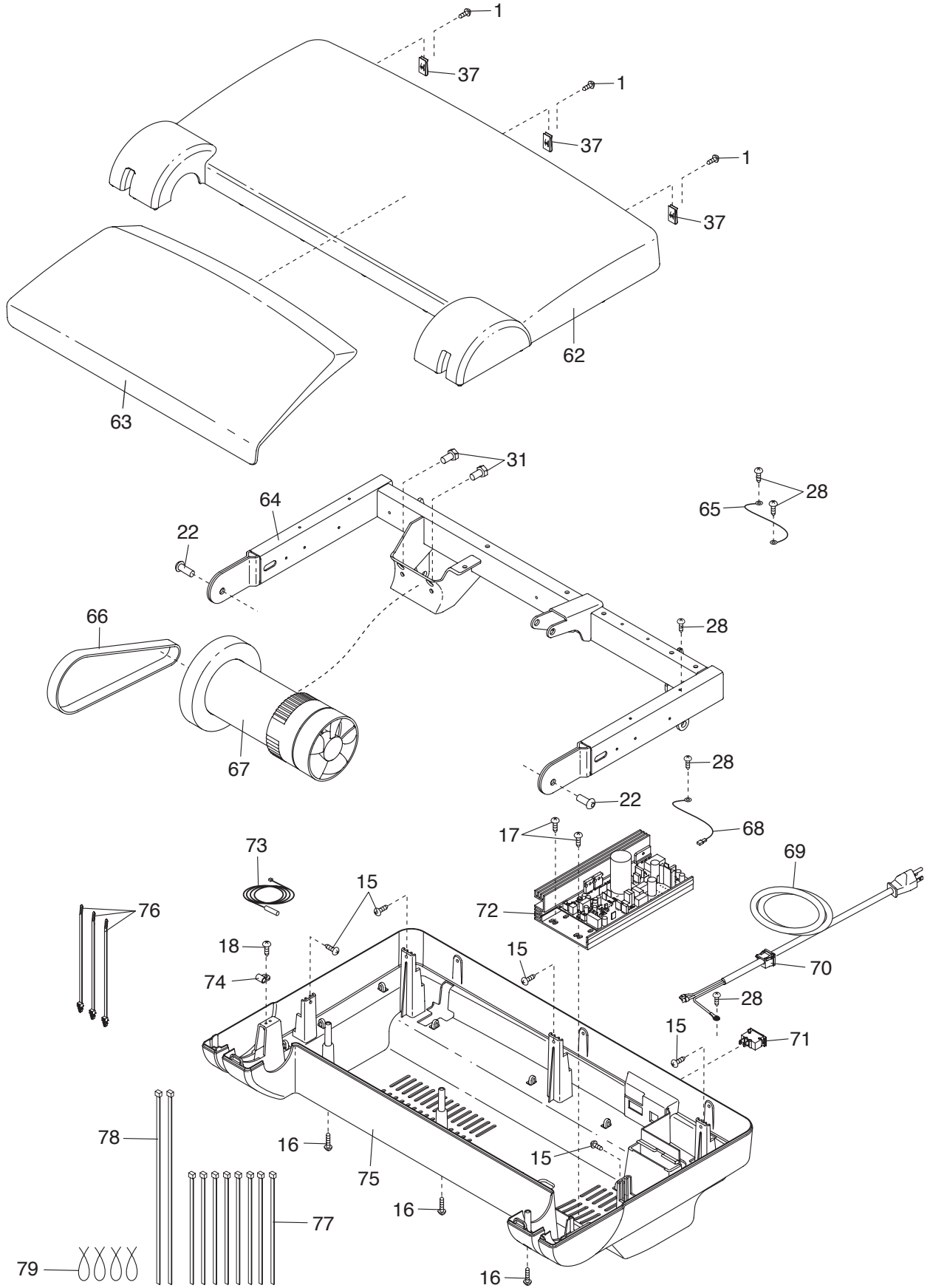

# EXPLODED DRAWING C

Model No. PFTL59011.0 R0512A

