

# EXPLODED DRAWING A

Model No. PFTL59013.3 R1014A

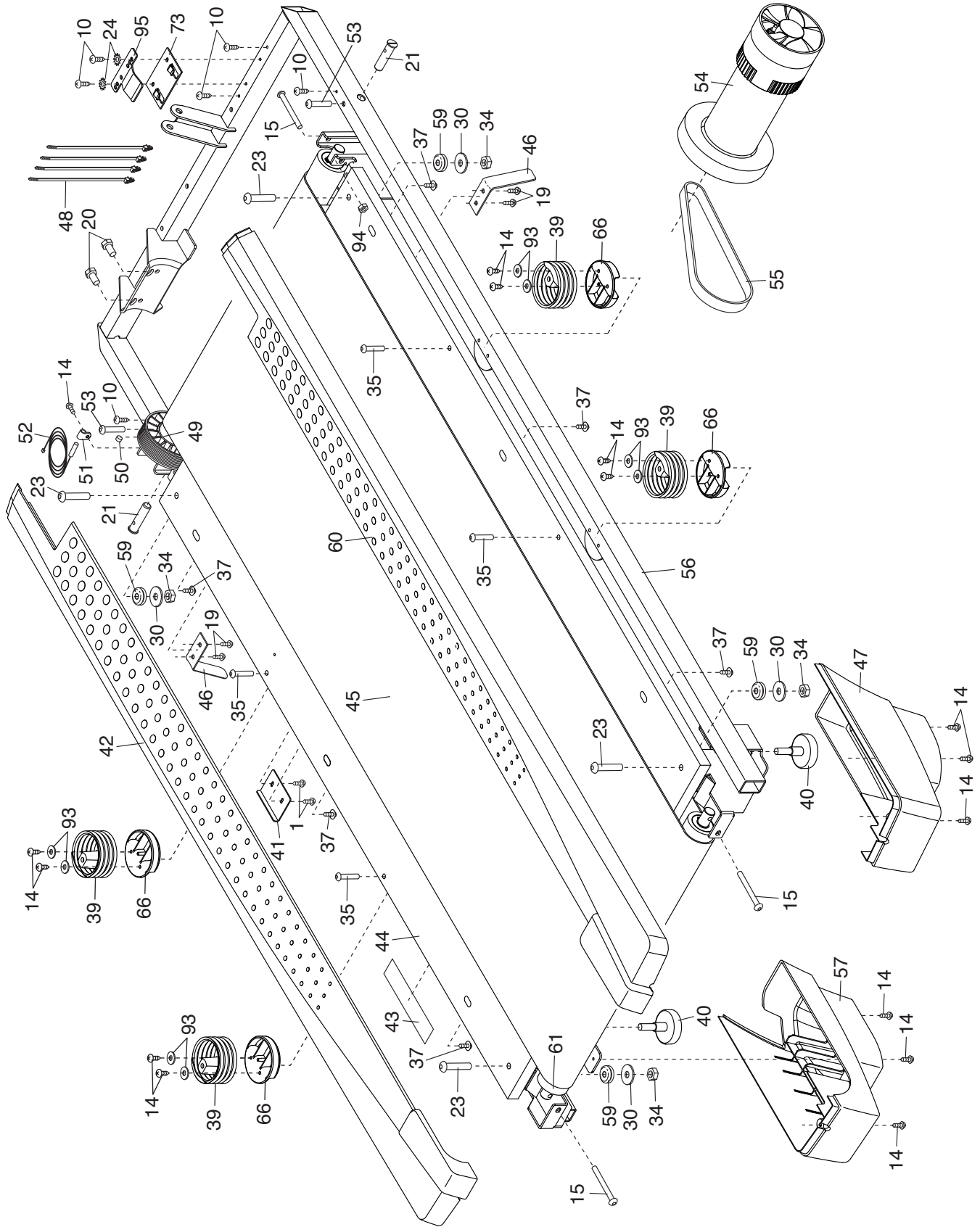

# EXPLODED DRAWING B

Model No. PFTL59013.3 R1014A

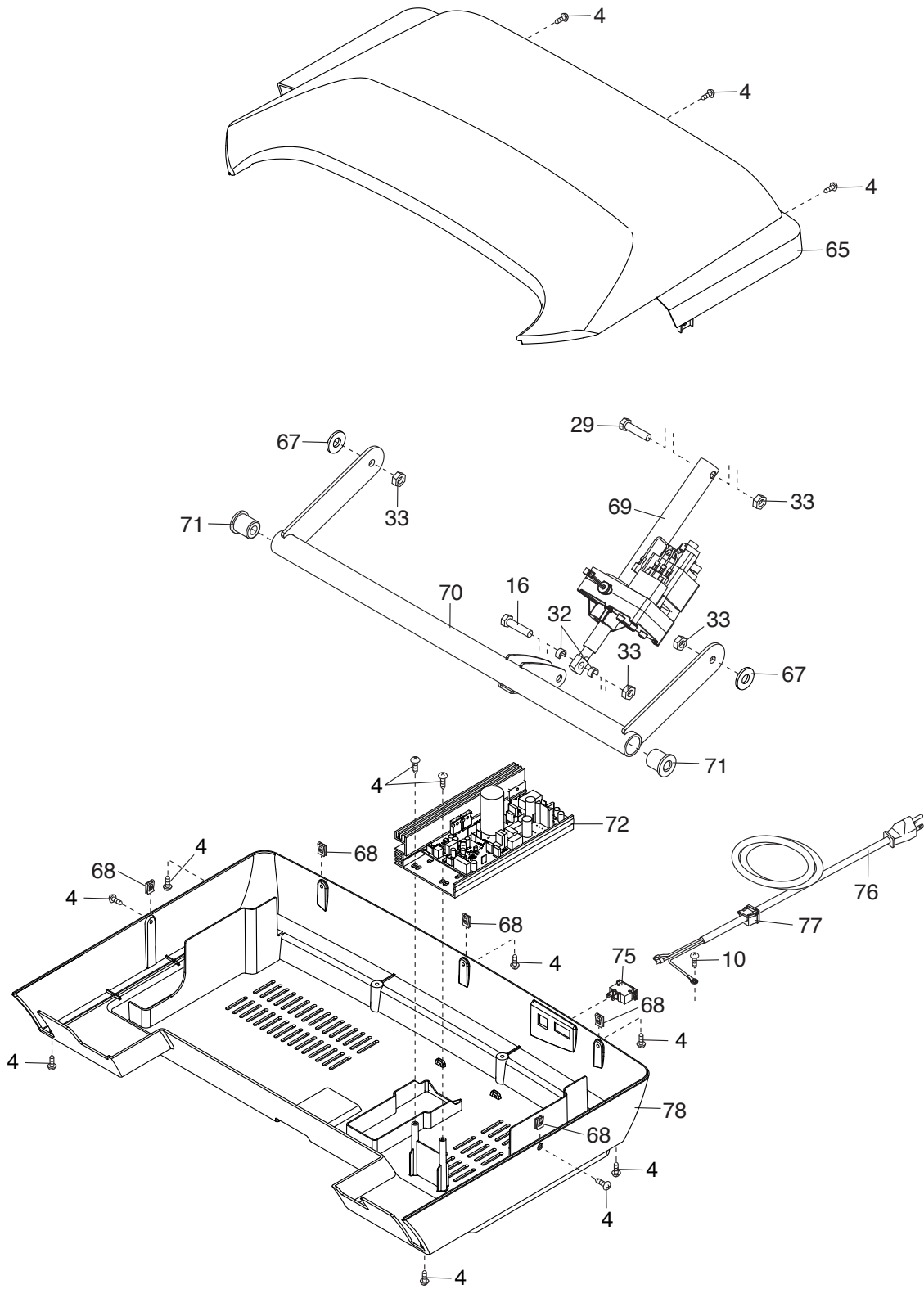

# EXPLODED DRAWING C

Model No. PFTL59013.3 R1014A

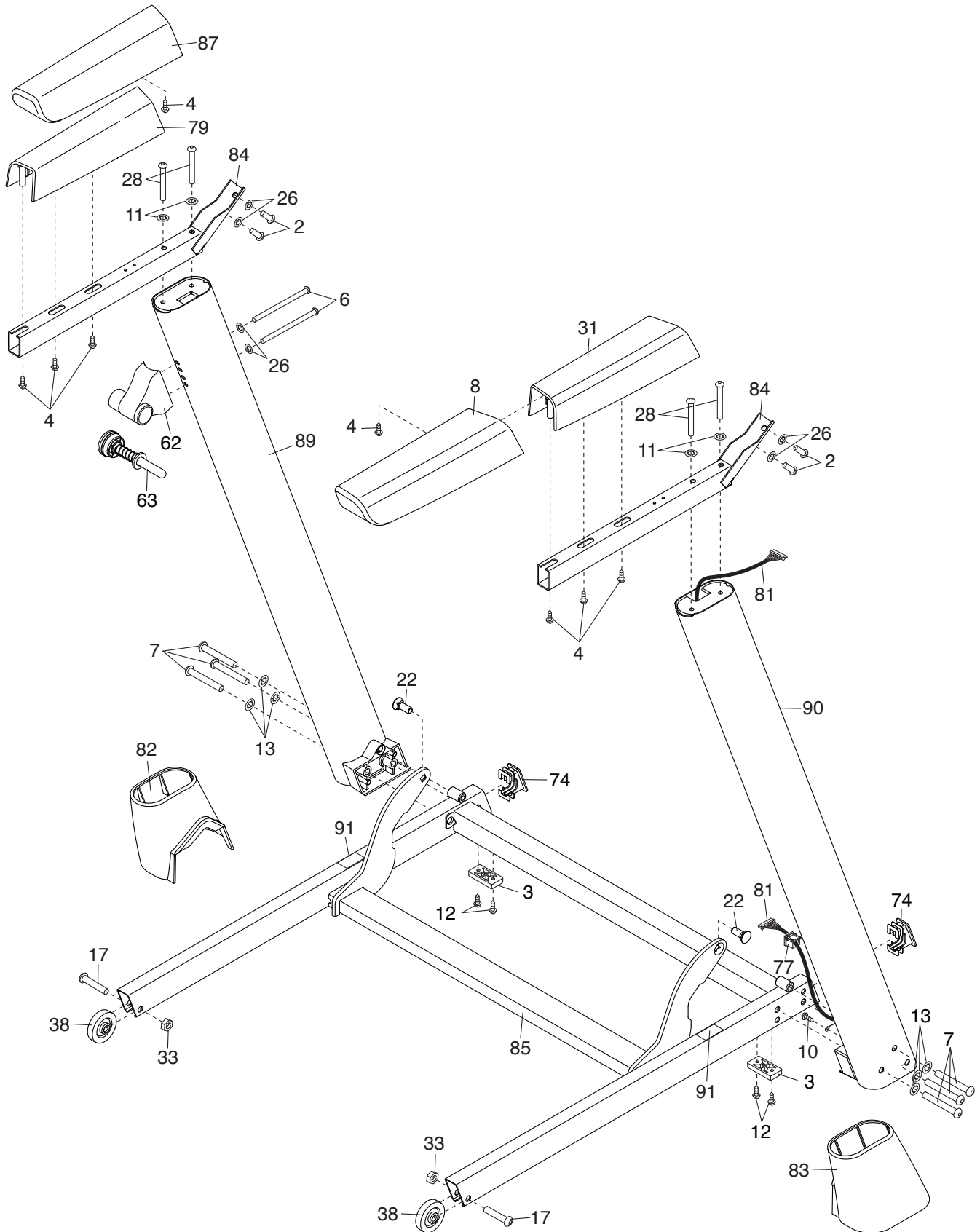

# EXPLODED DRAWING D

Model No. PFTL59013.3 R1014A

