

EXPLODED DRAWING A

Model No. PFTL59014.1 R0914A

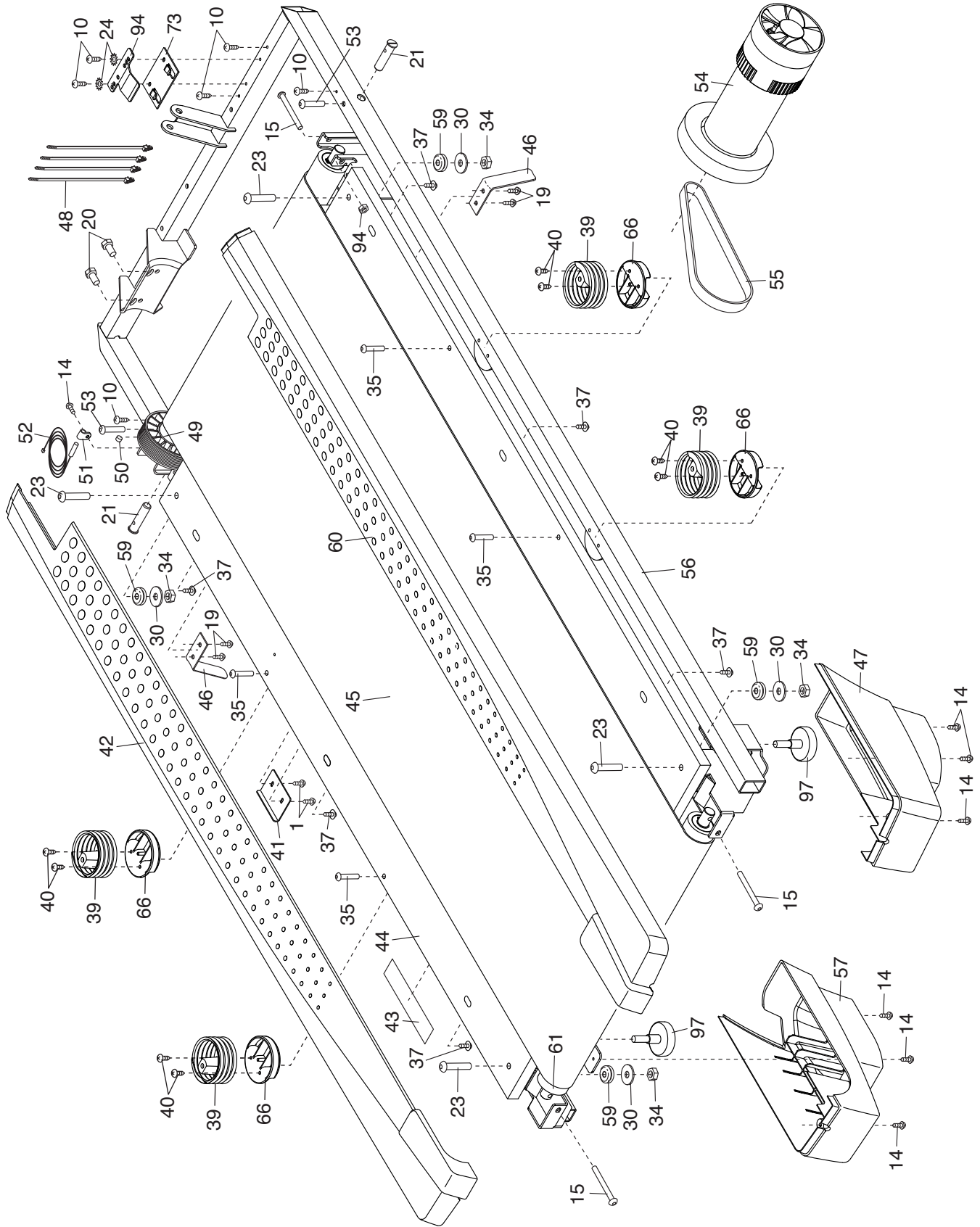

EXPLODED DRAWING B

Model No. PFTL59014.1 R0914A

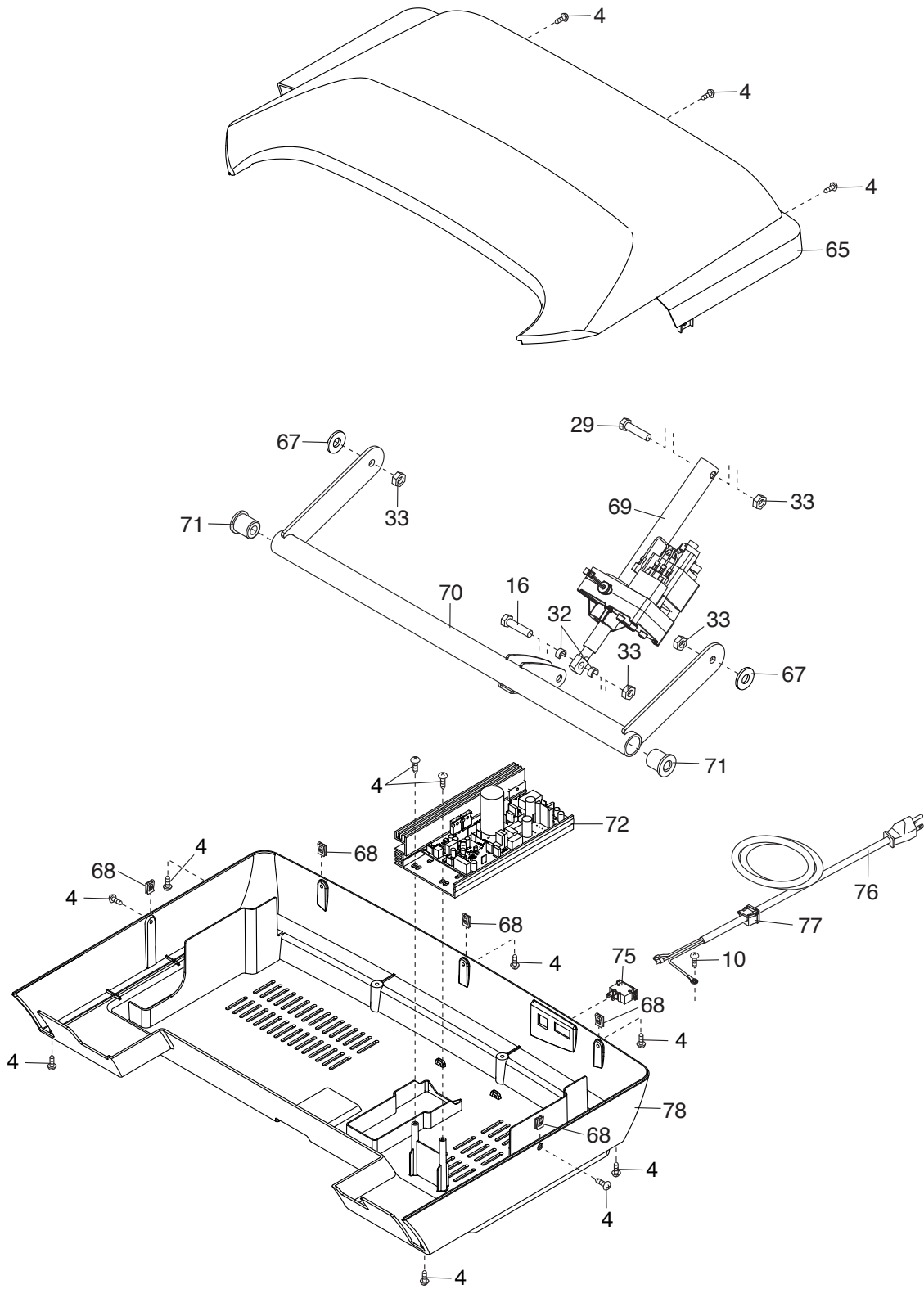

EXPLODED DRAWING C

Model No. PFTL59014.1 R0914A

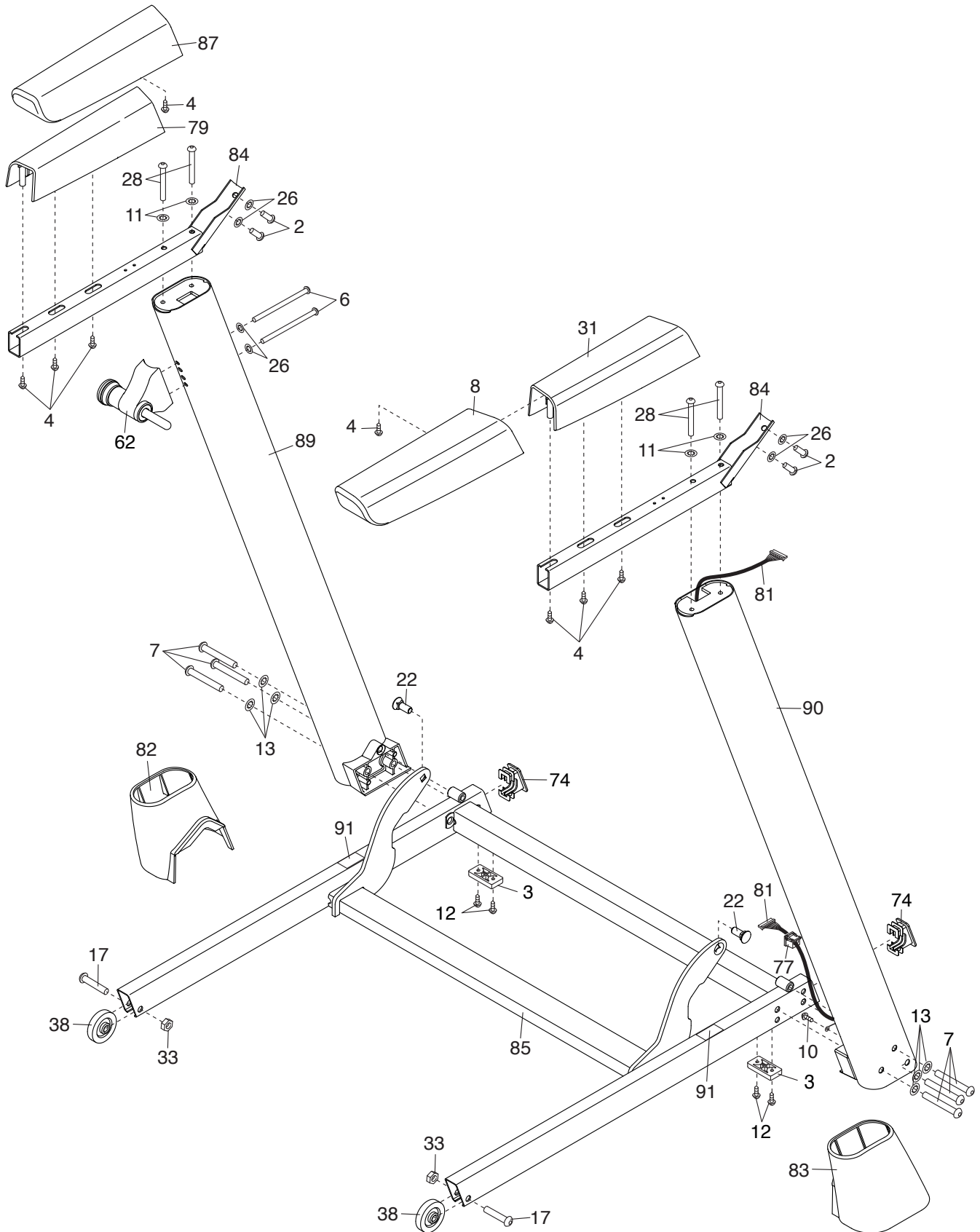

EXPLODED DRAWING D

Model No. PFTL59014.1 R0914A

