

# EXPLODED DRAWING A

Model No. PFTL59117.1 R1017A

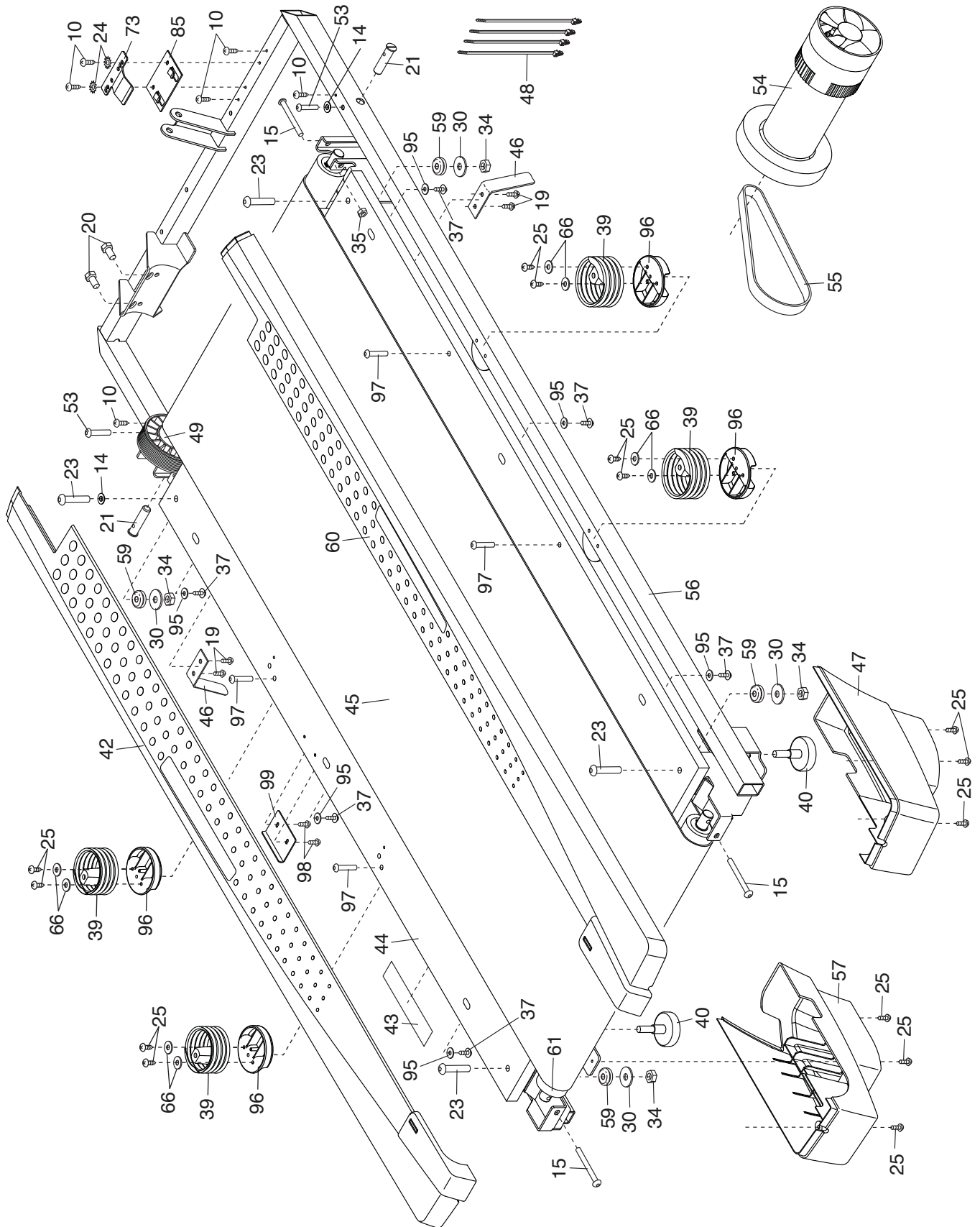

# EXPLODED DRAWING B

Model No. PFTL59117.1 R1017A

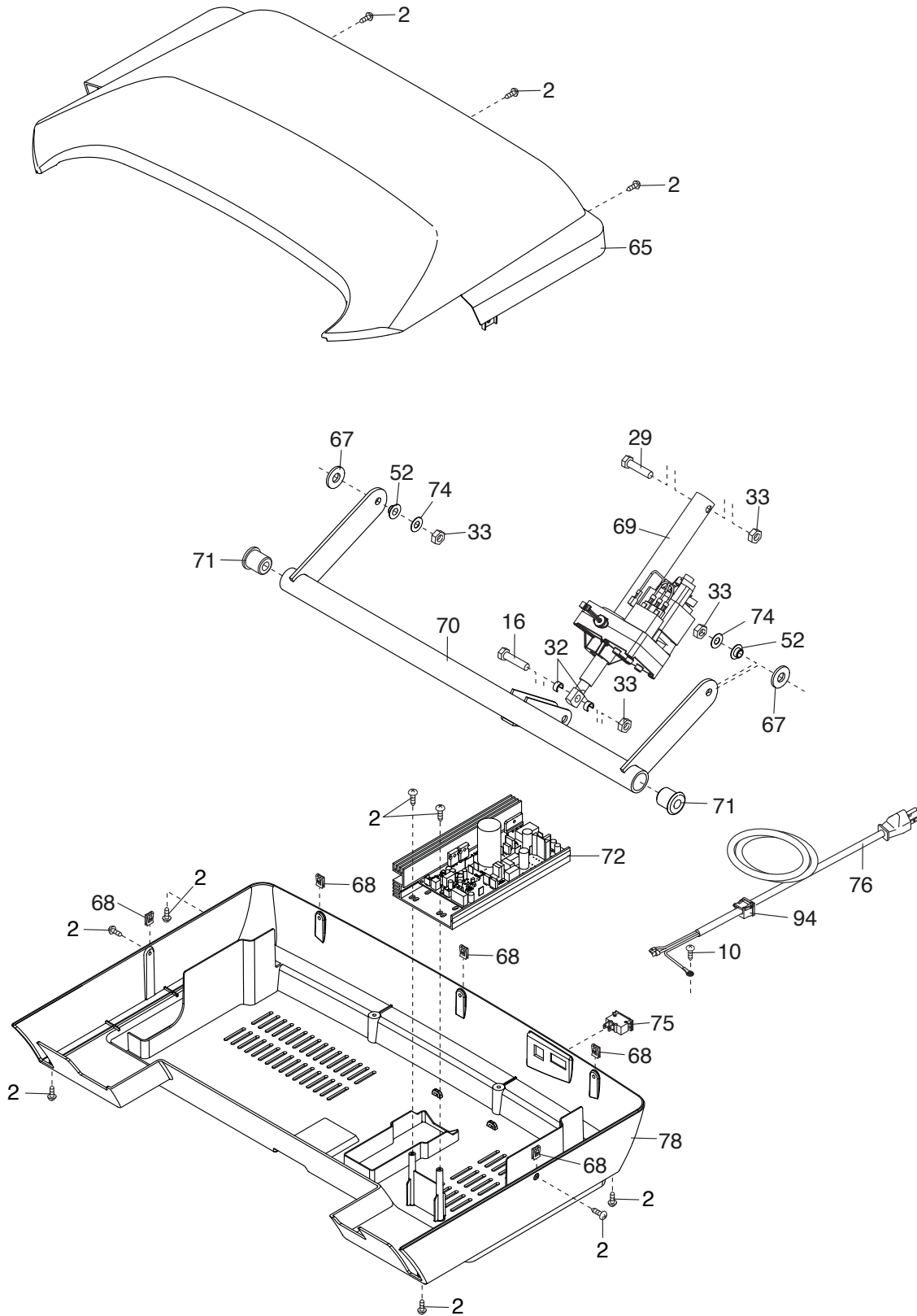

# EXPLODED DRAWING C

Model No. PFTL59117.1 R1017A

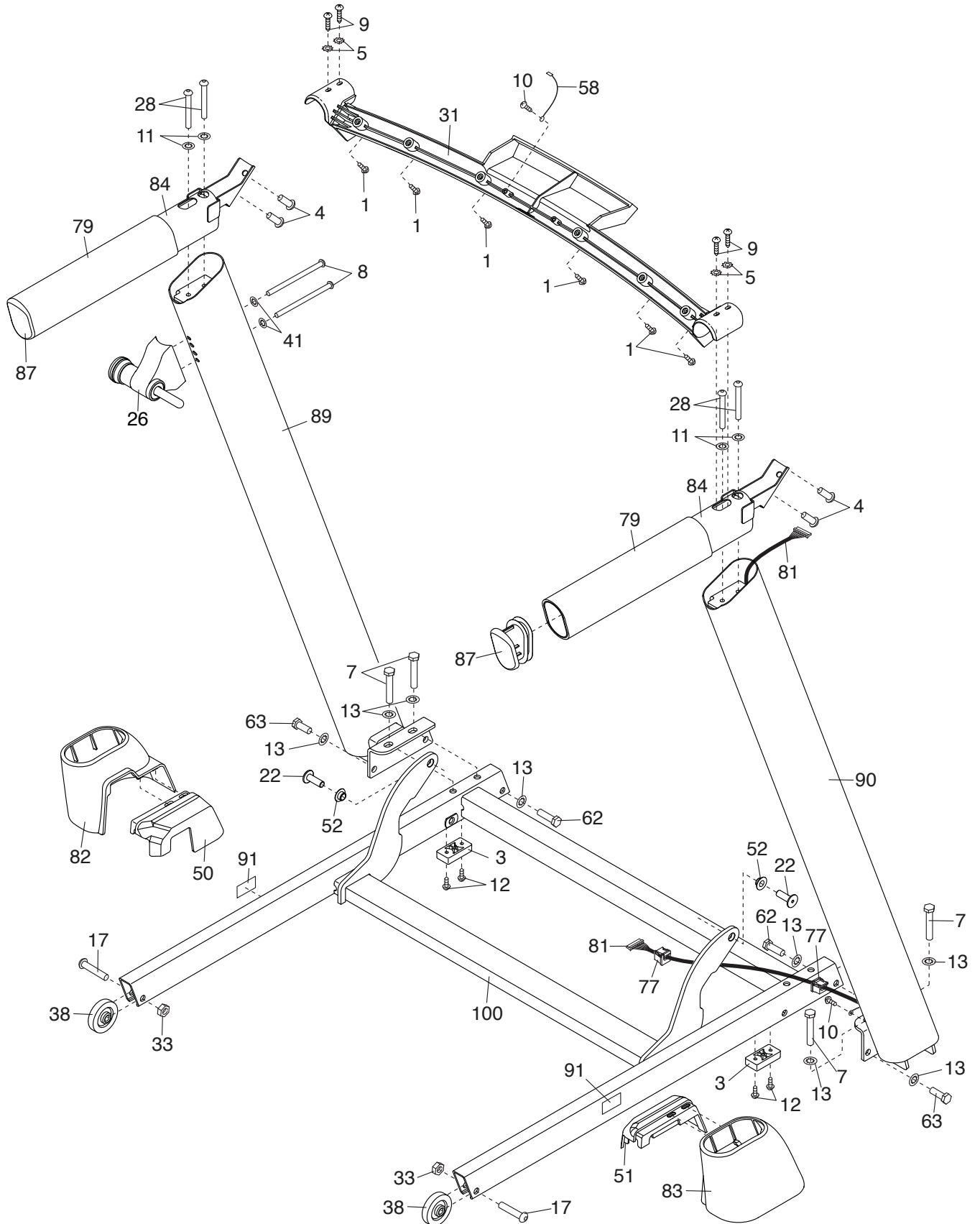

# EXPLODED DRAWING D

Model No. PFTL59117.1 R1017A

