

EXPLODED DRAWING B

Model No. PFTL59117.2 R1118A

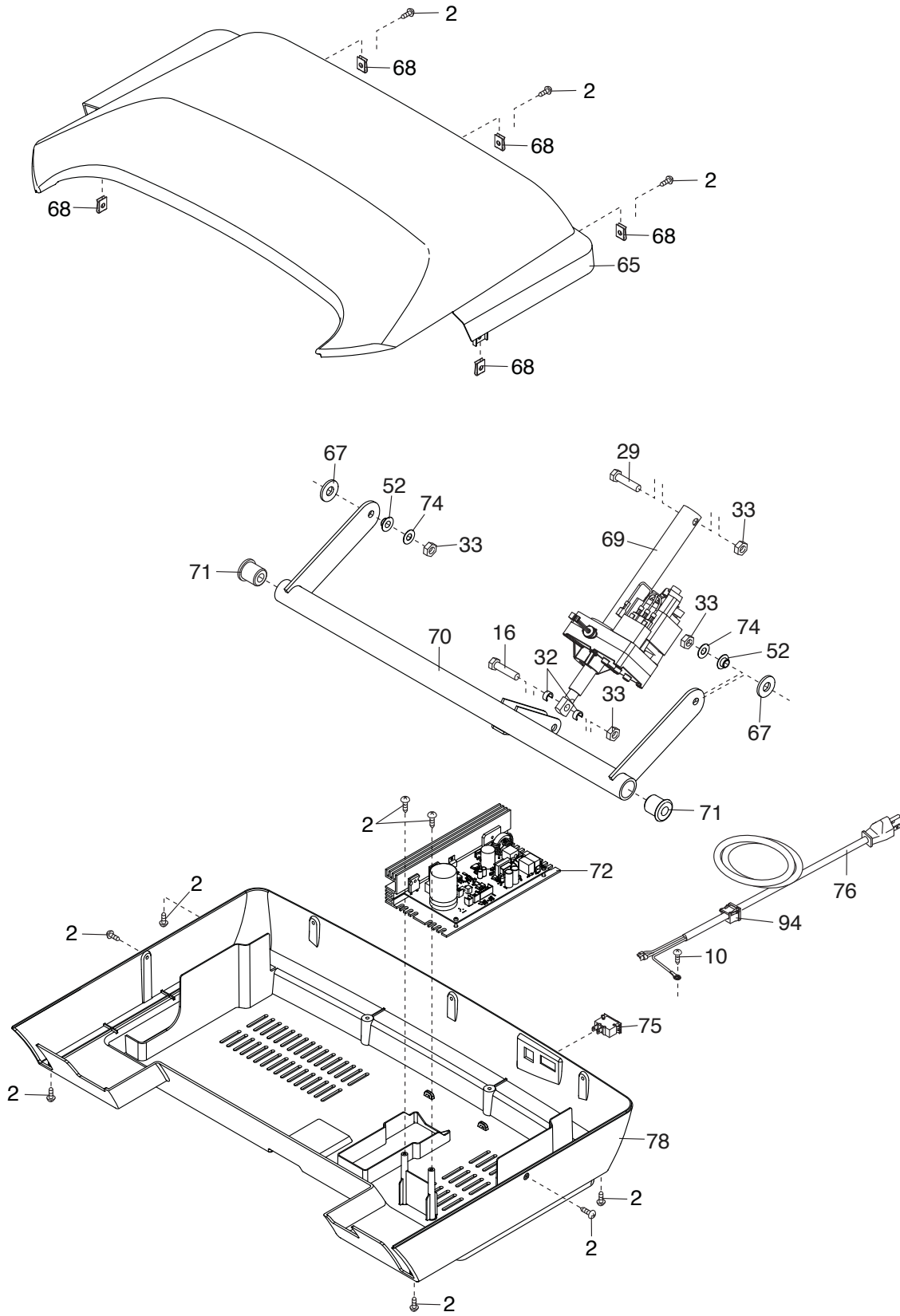

EXPLODED DRAWING C

Model No. PFTL59117.2 R1118A

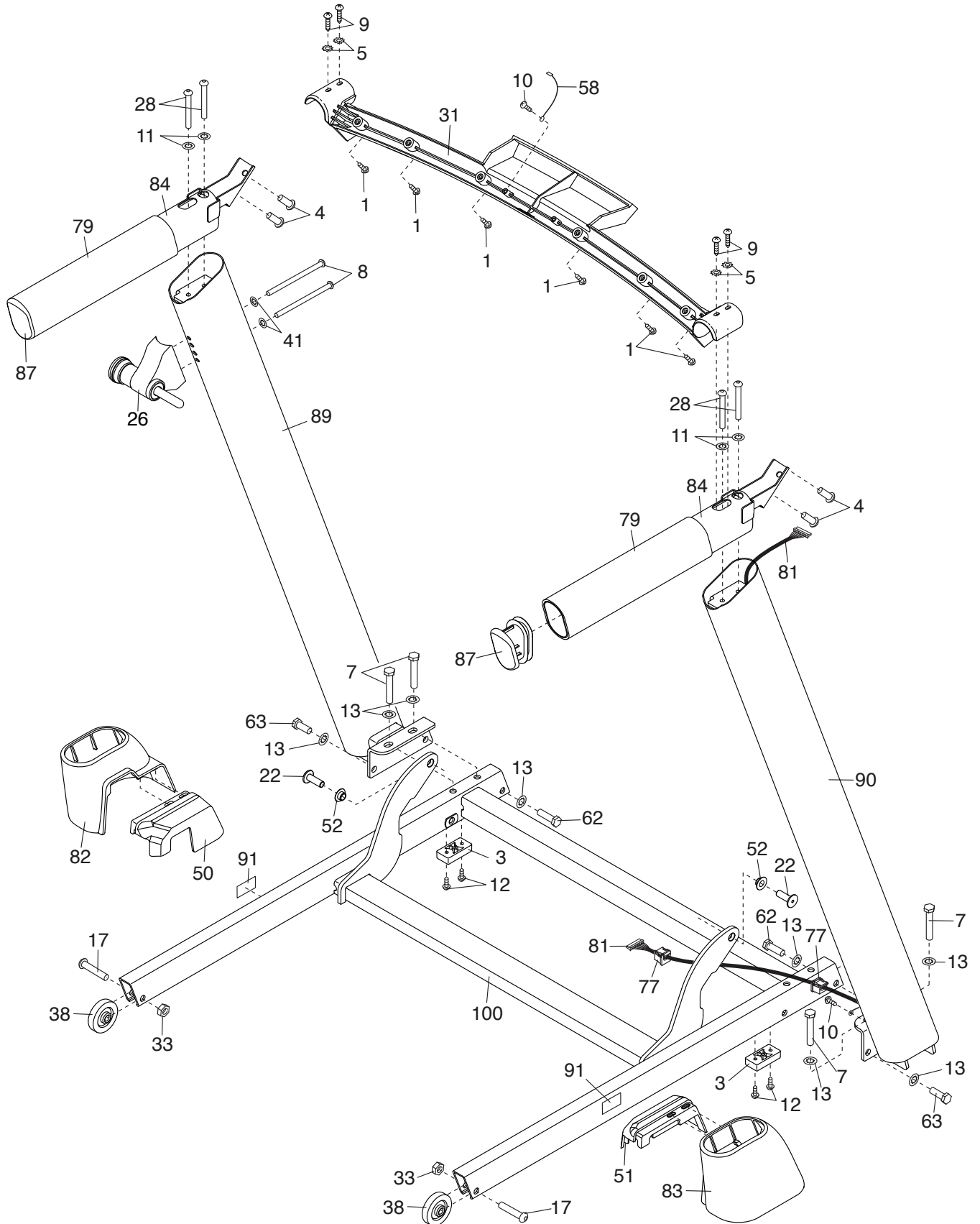

EXPLODED DRAWING D

Model No. PFTL59117.2 R1118A

