

EXPLODED DRAWING A

Model No. PFTL59117.3 R0818A

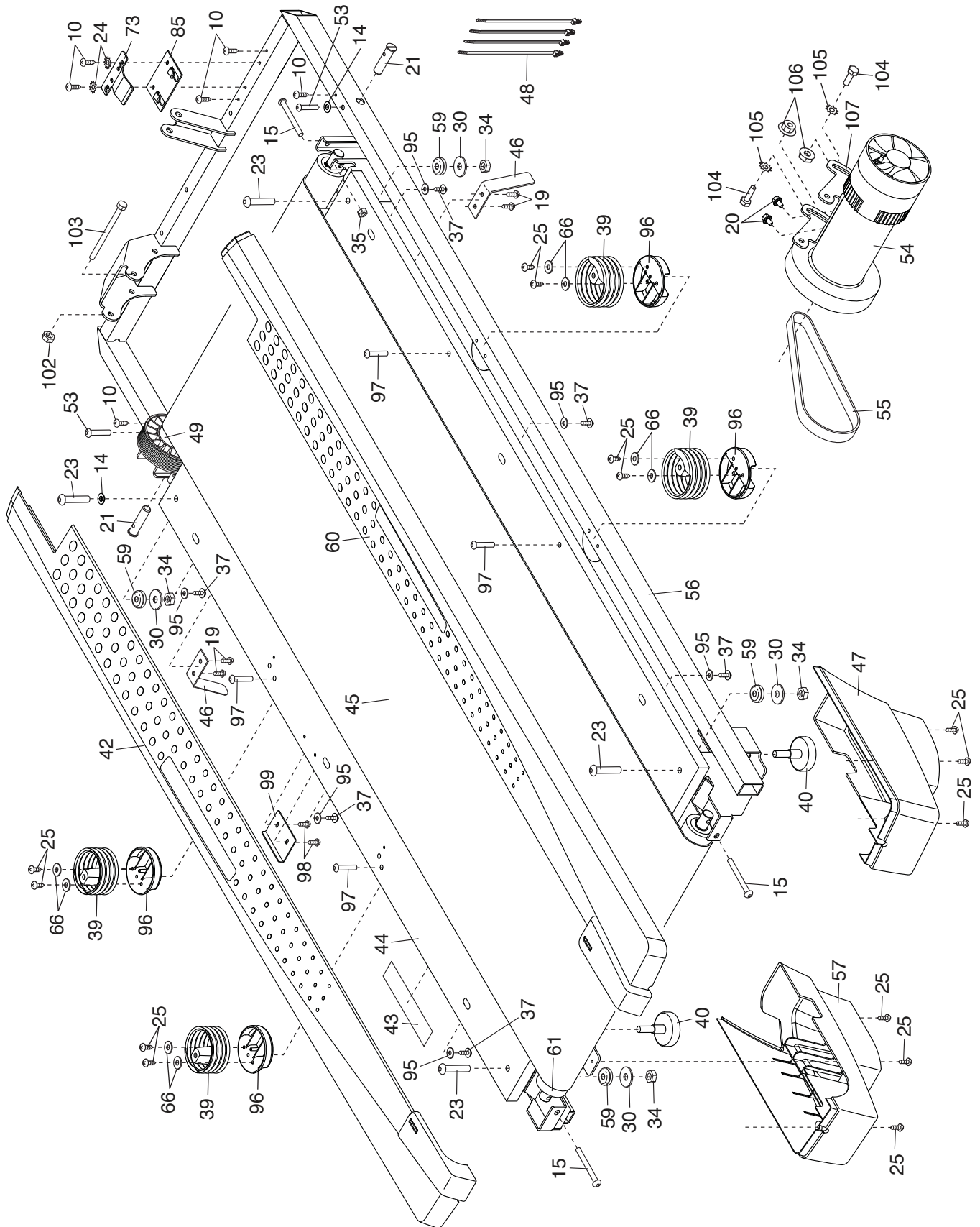

EXPLODED DRAWING B

Model No. PFTL59117.3 R0818A

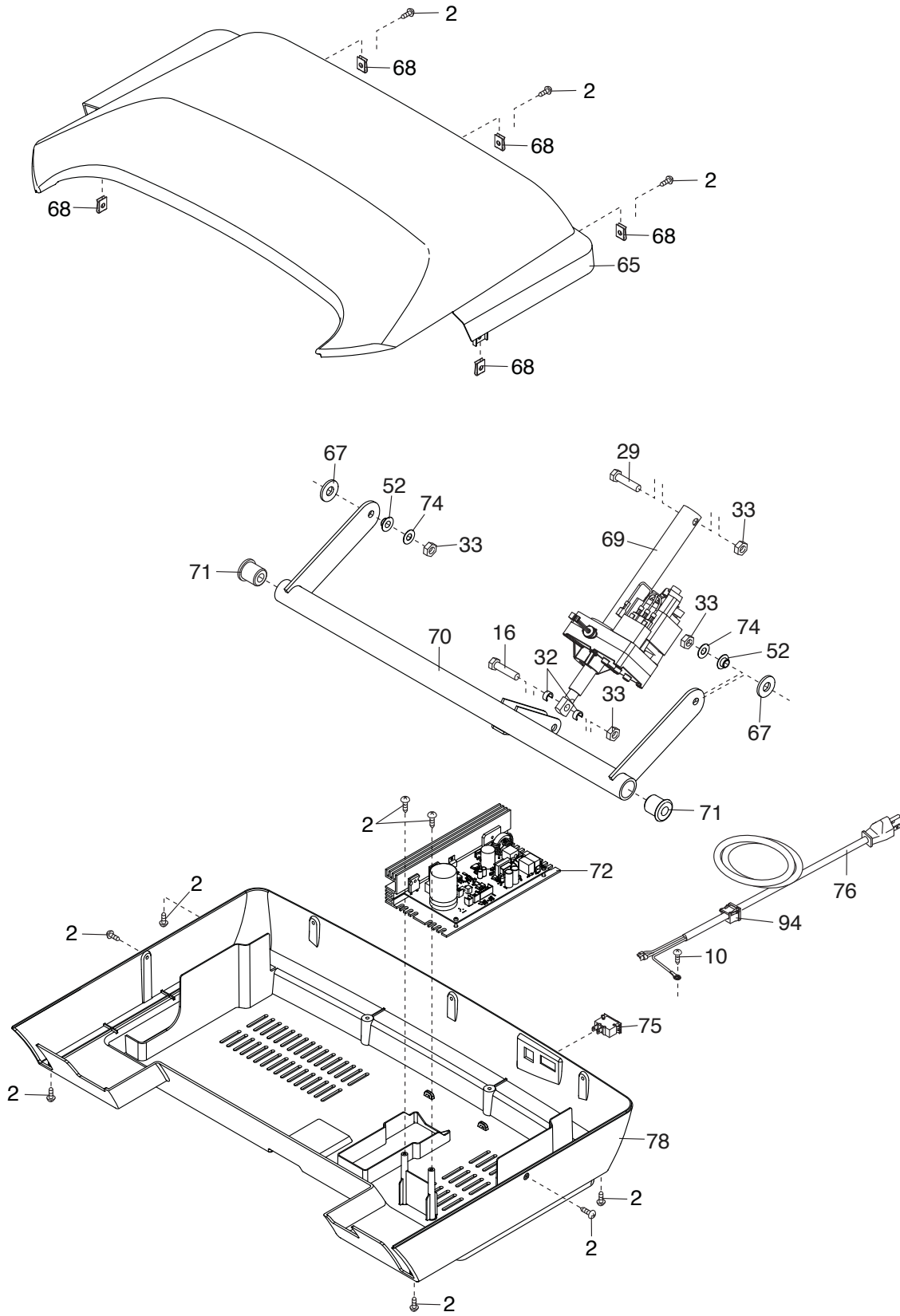

EXPLODED DRAWING C

Model No. PFTL59117.3 R0818A

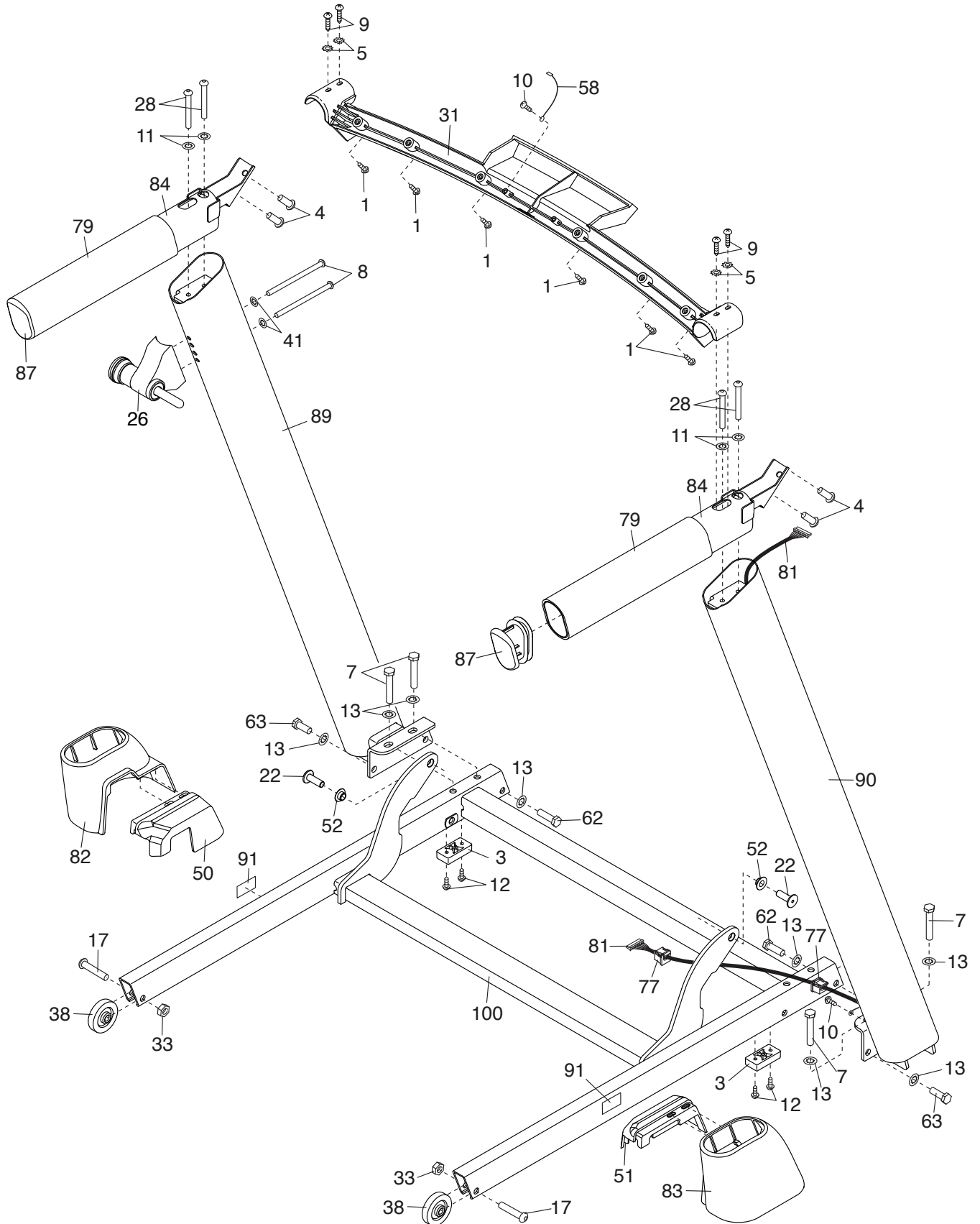

EXPLODED DRAWING D

Model No. PFTL59117.3 R0818A

