

EXPLODED DRAWING A—Model No. PFTL59508.0

R0608A

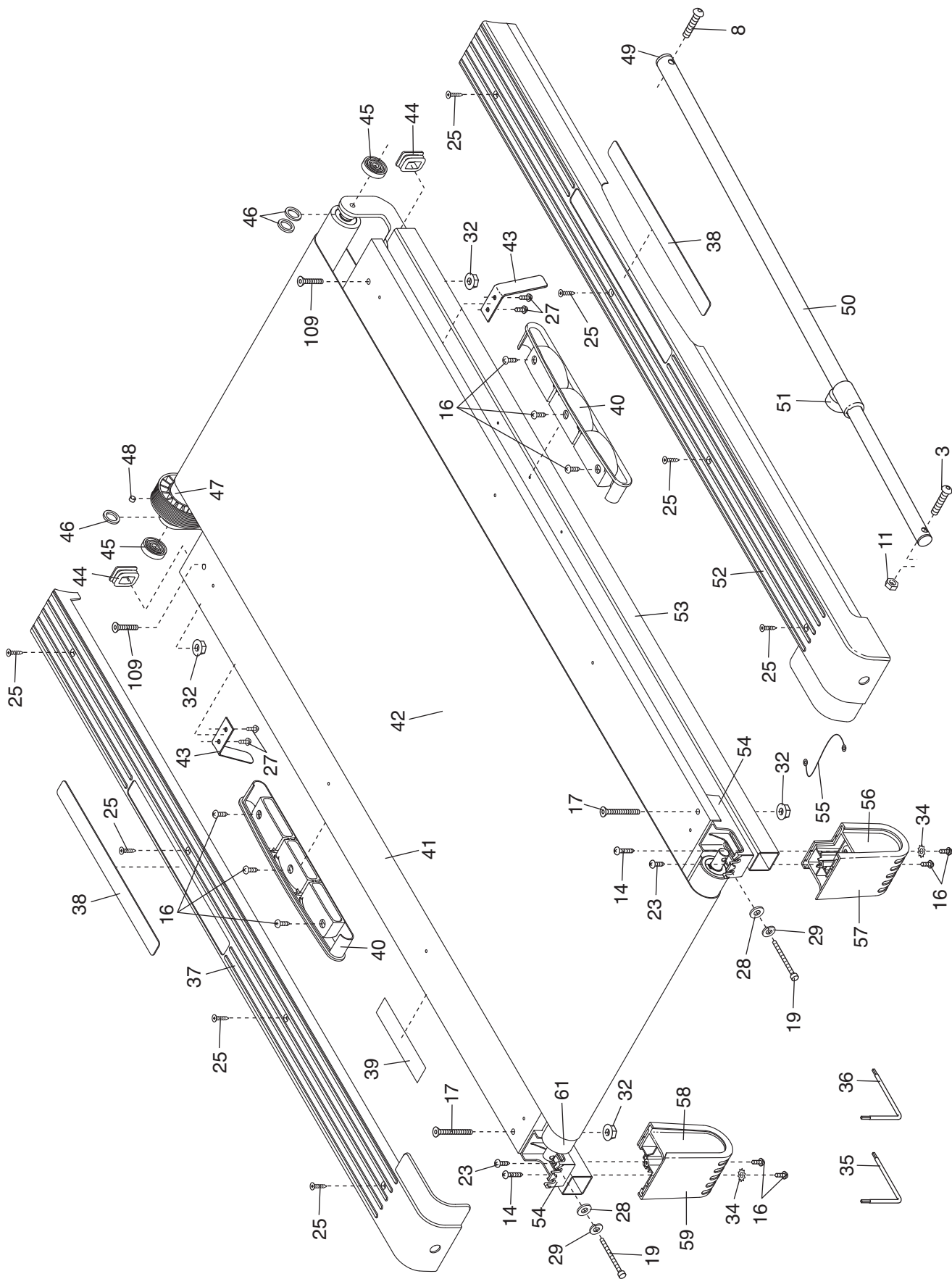

EXPLODED DRAWING B—Model No. PFTL59508.0

R0608A

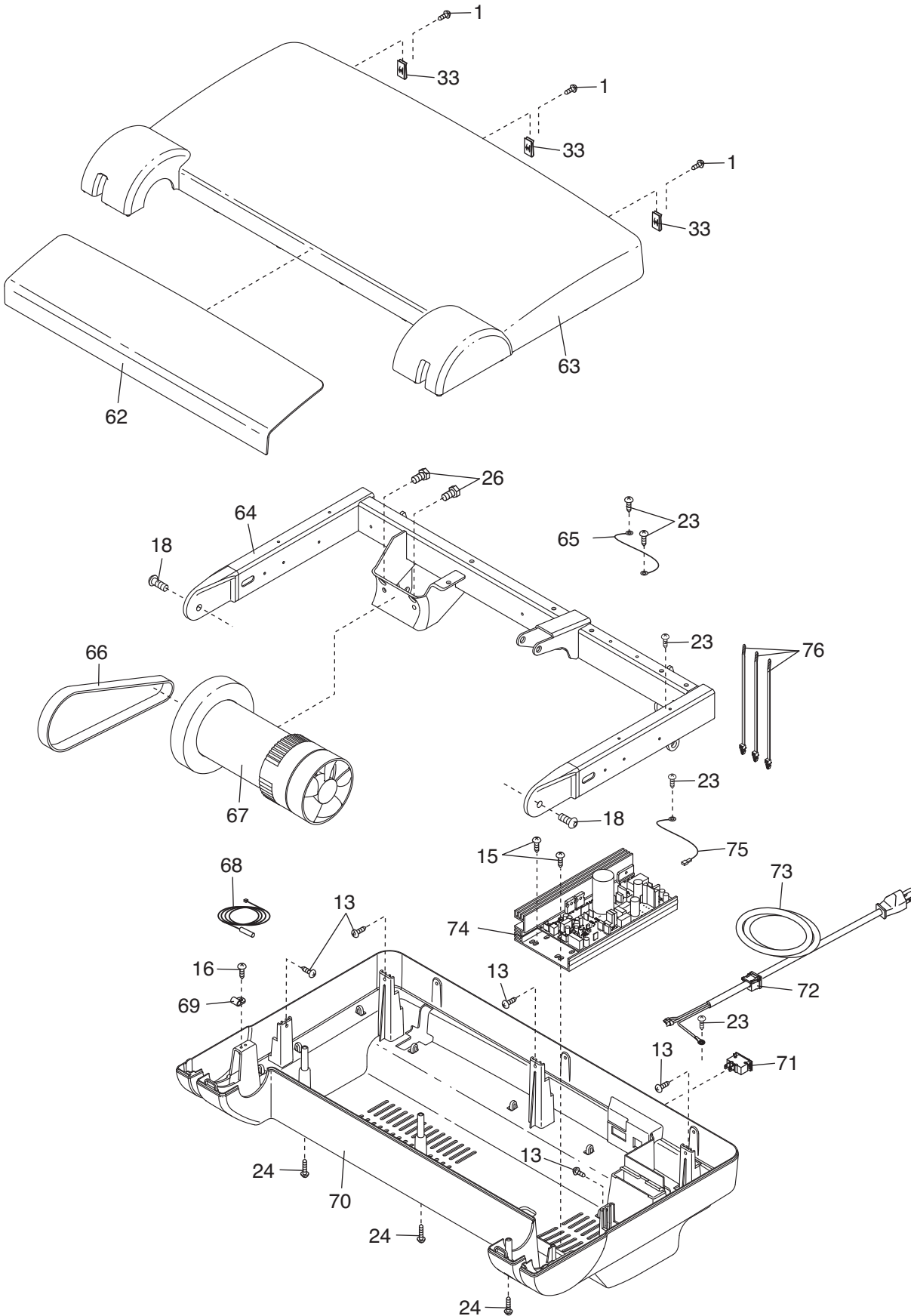

EXPLODED DRAWING C—Model No. PFTL59508.0

R0608A

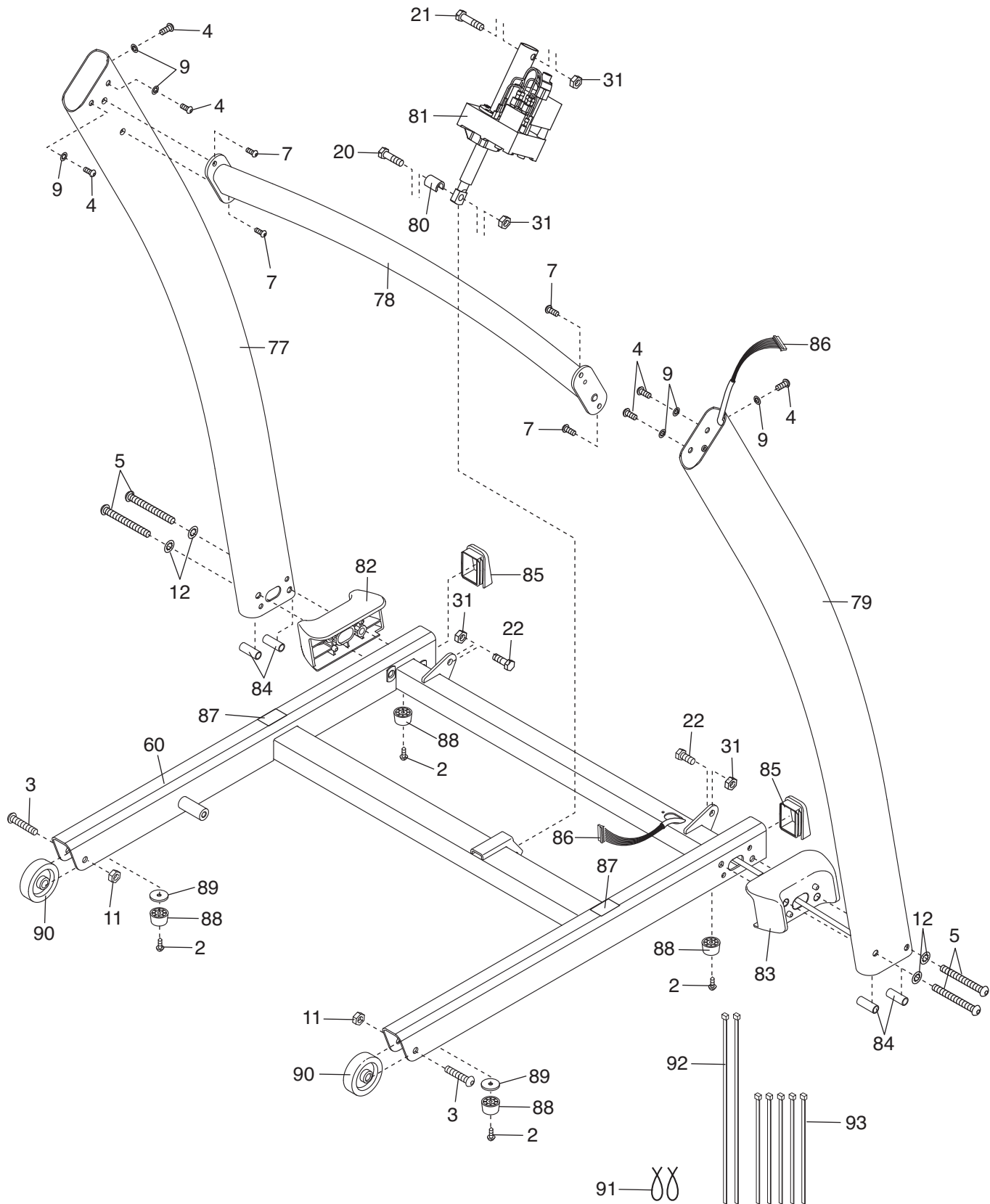

EXPLODED DRAWING D—Model No. PFTL59508.0

R0608A

