

# EXPLODED DRAWING A—Model No. PFTL59508.3

R0709A

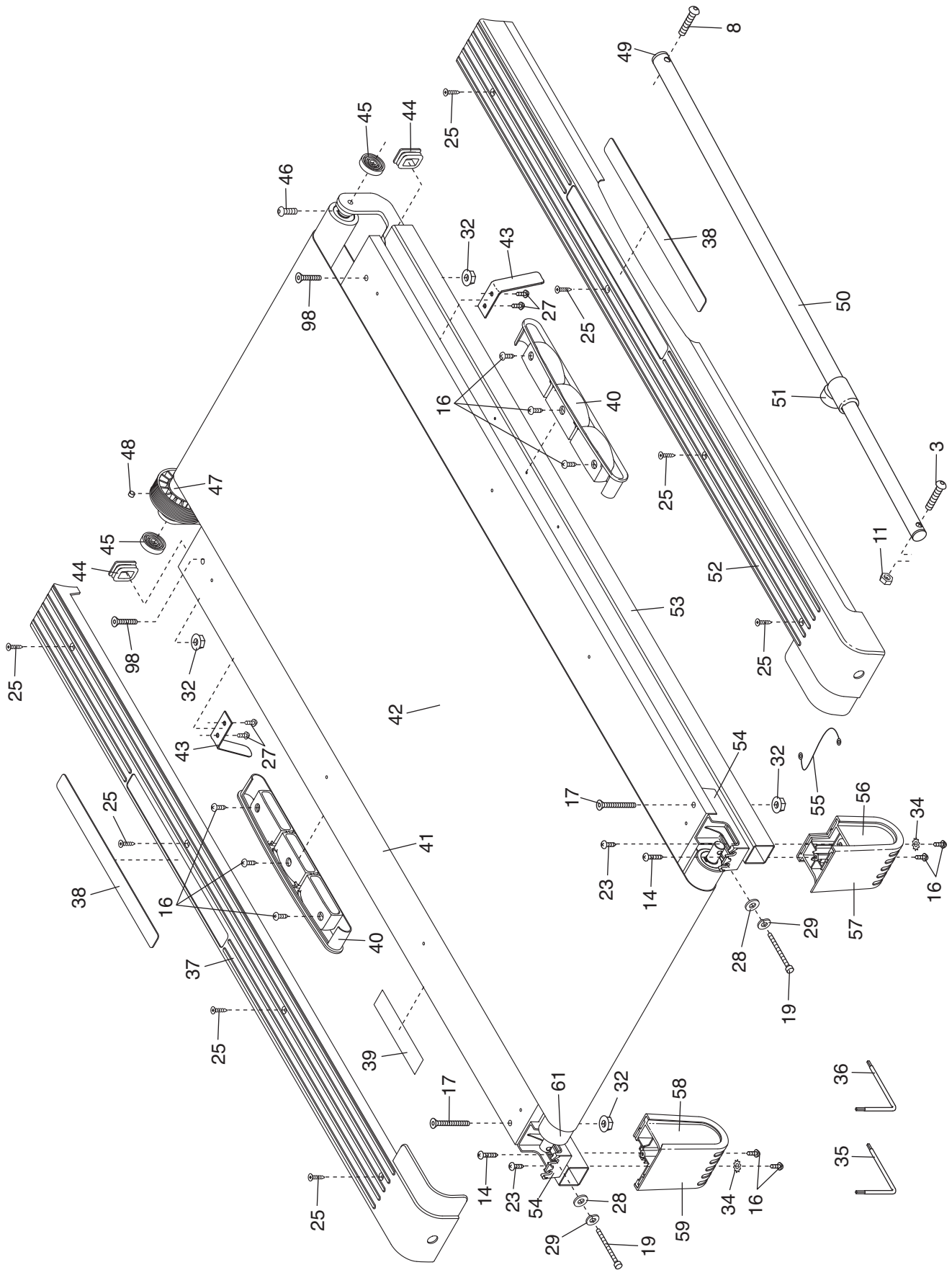

# EXPLODED DRAWING B—Model No. PFTL59508.3

R0709A

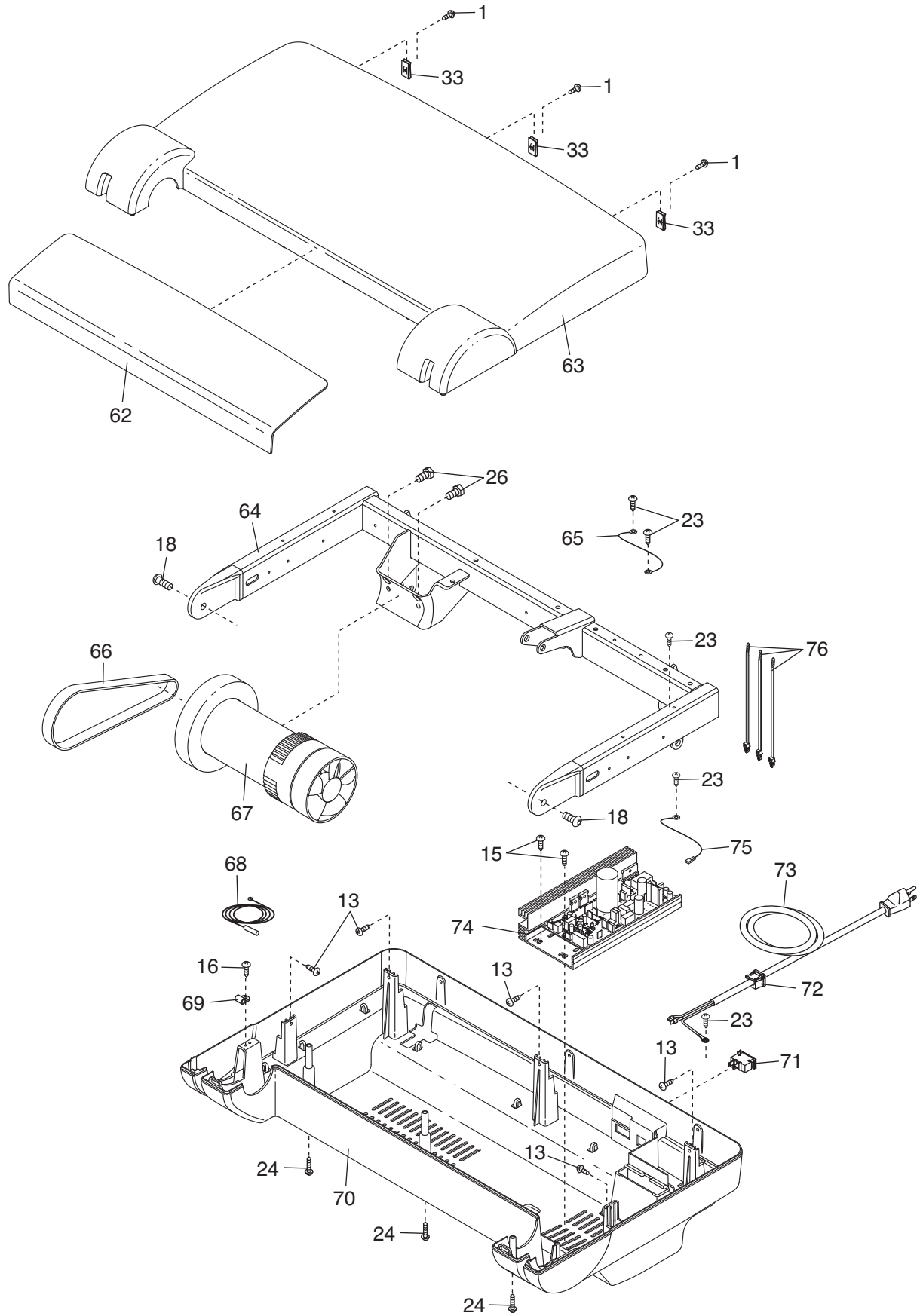

# EXPLODED DRAWING C—Model No. PFTL59508.3

R0709A

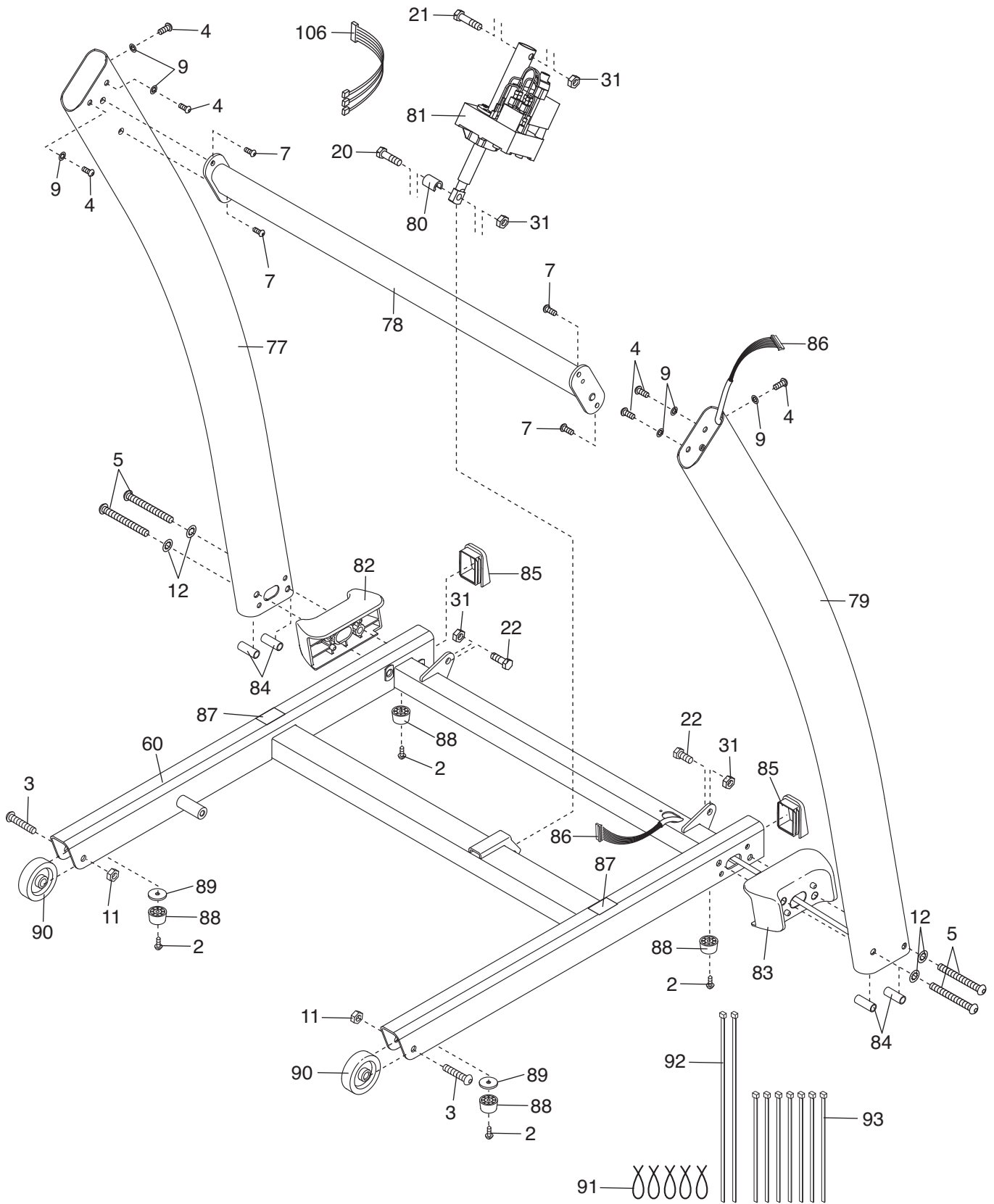

# EXPLODED DRAWING D—Model No. PFTL59508.3

R0709A

