

EXPLODED DRAWING A

Model No. PFTL59513.2 R0514A

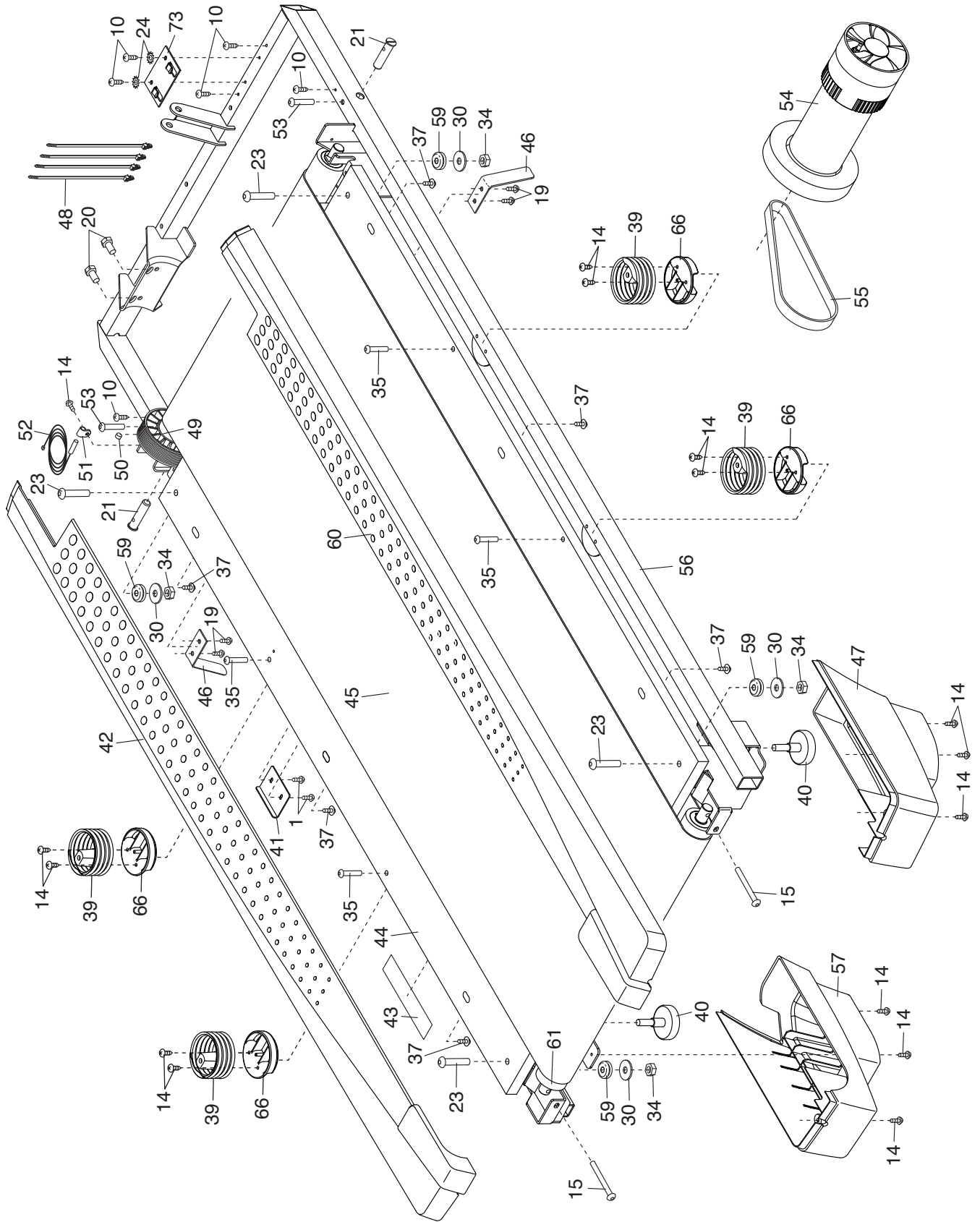

EXPLODED DRAWING B

Model No. PFTL59513.2 R0514A

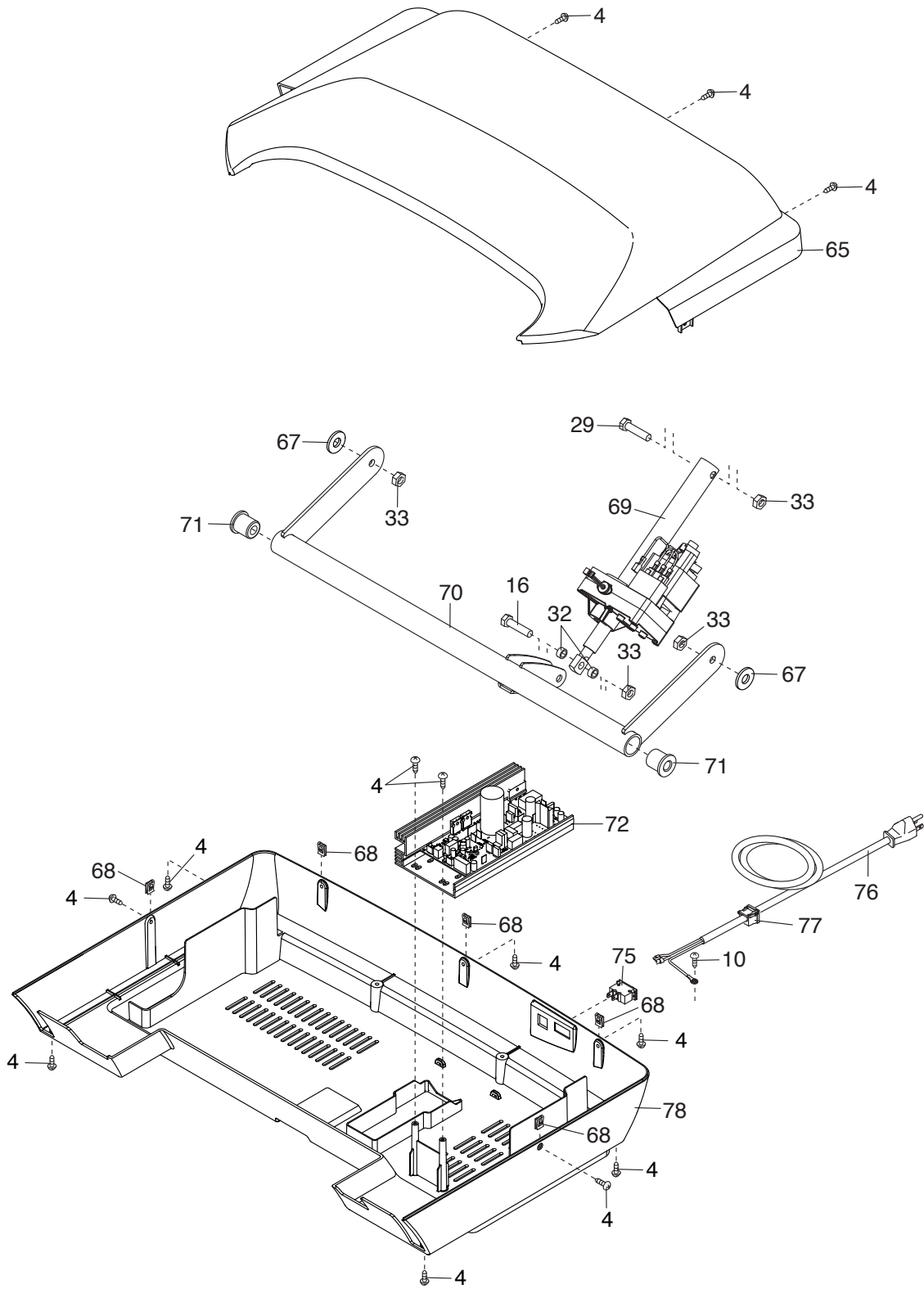

EXPLODED DRAWING C

Model No. PFTL59513.2 R0514A

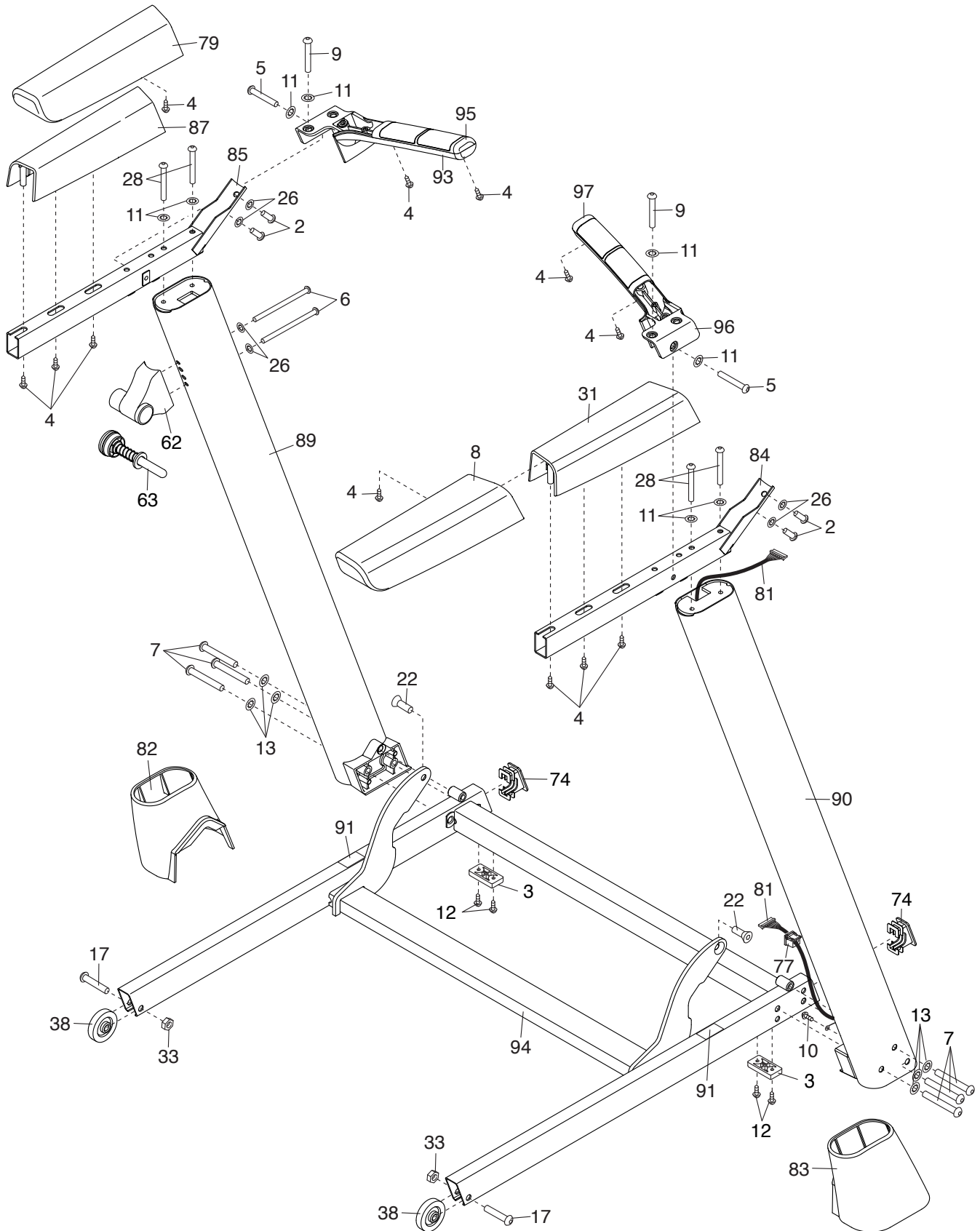

EXPLODED DRAWING D

Model No. PFTL59513.2 R0514A

