

EXPLODED DRAWING A

Model No. PFTL59513.0 R0913B

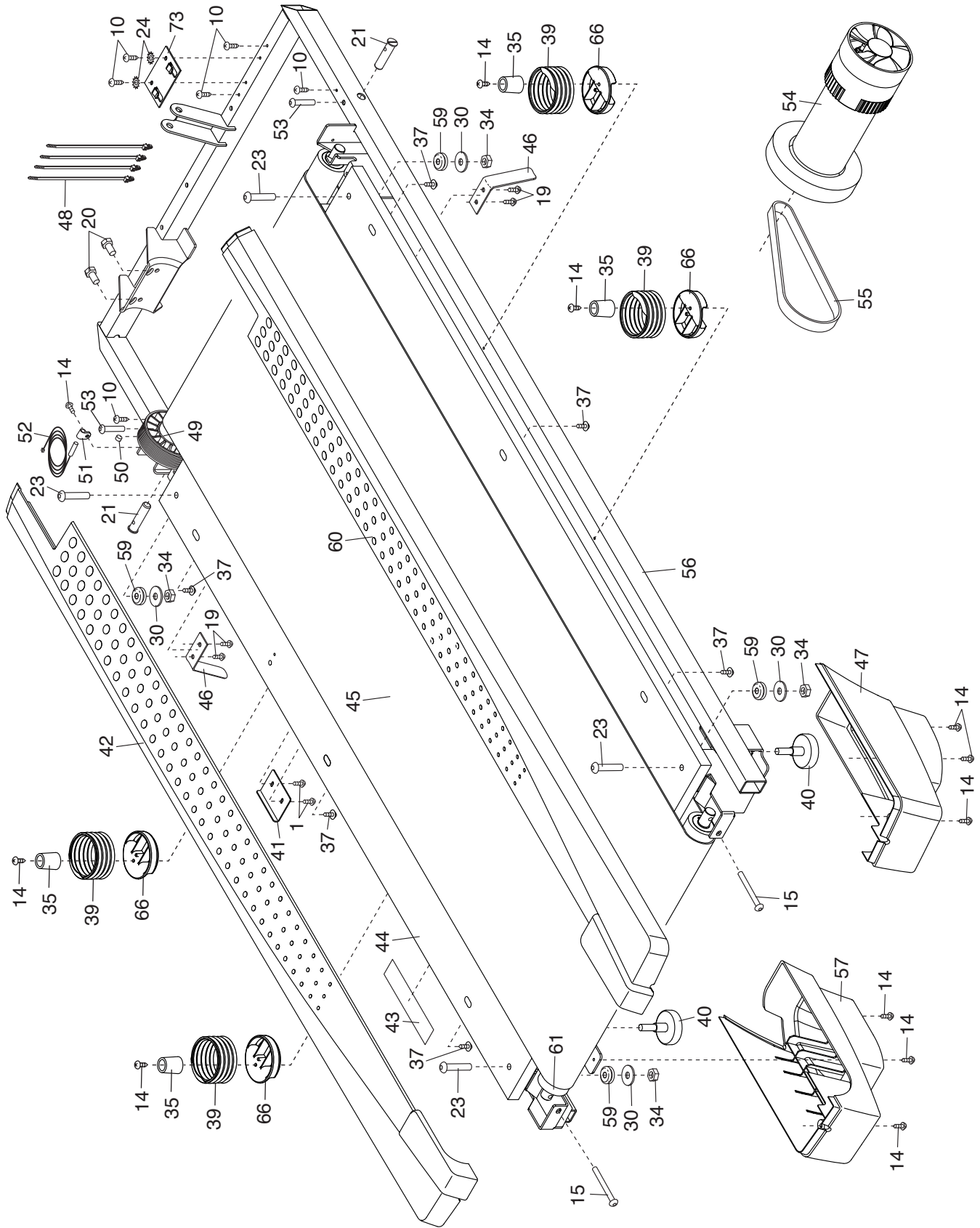

EXPLODED DRAWING B

Model No. PFTL59513.0 R0913B

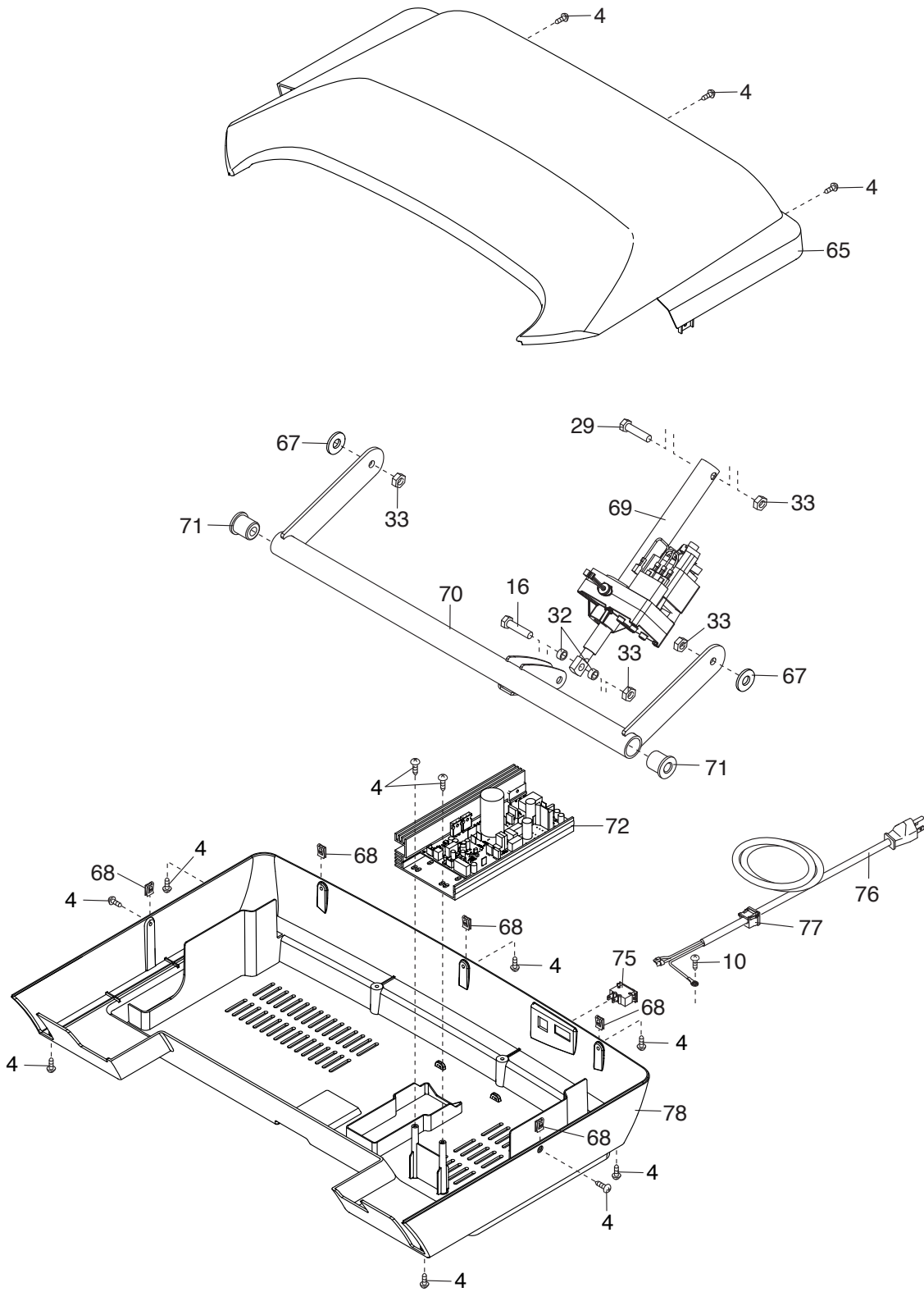

EXPLODED DRAWING C

Model No. PFTL59513.0 R0913B

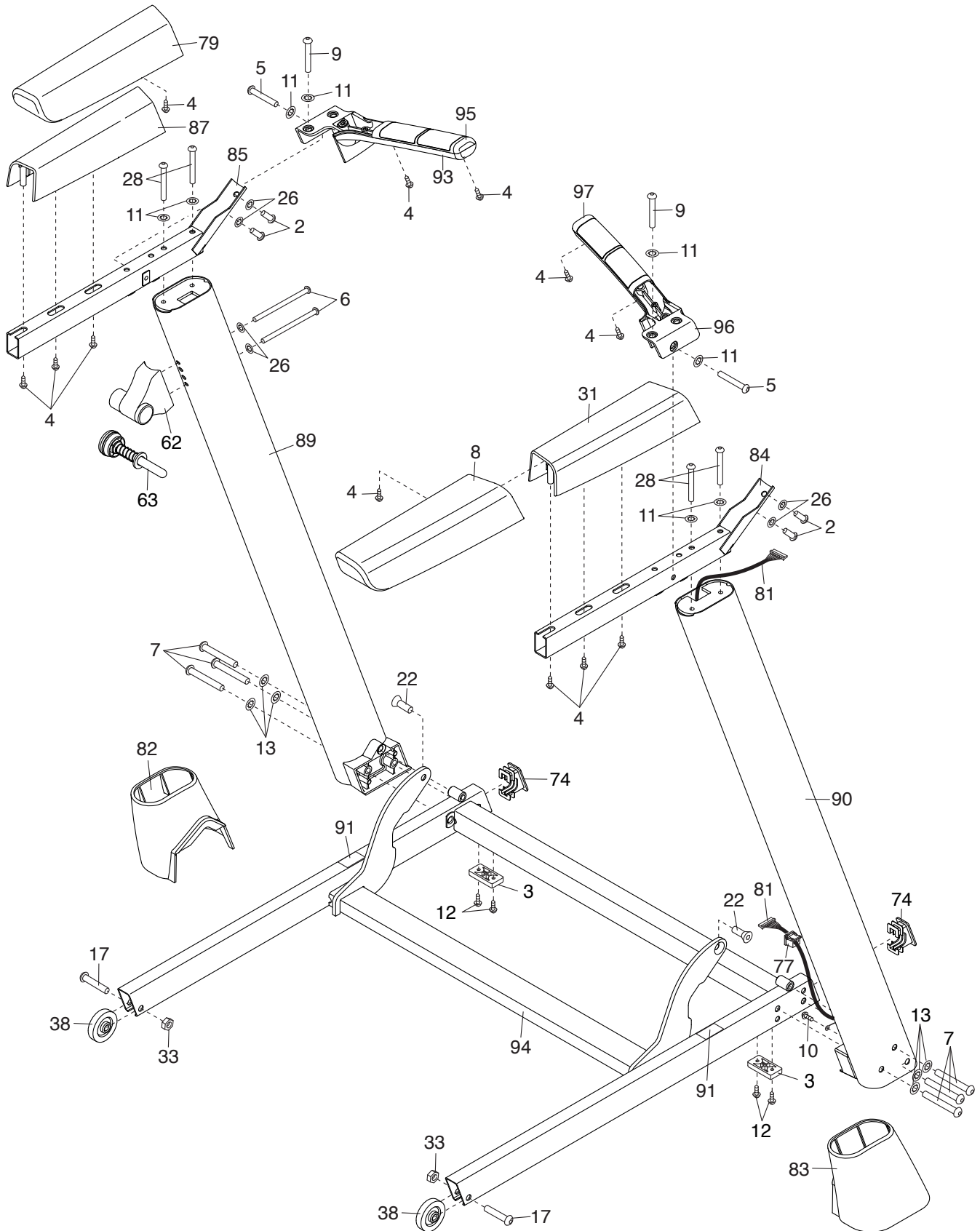

EXPLODED DRAWING D

Model No. PFTL59513.0 R0913B

