

EXPLODED DRAWING A

Model No. PFTL59513.3 R1214A

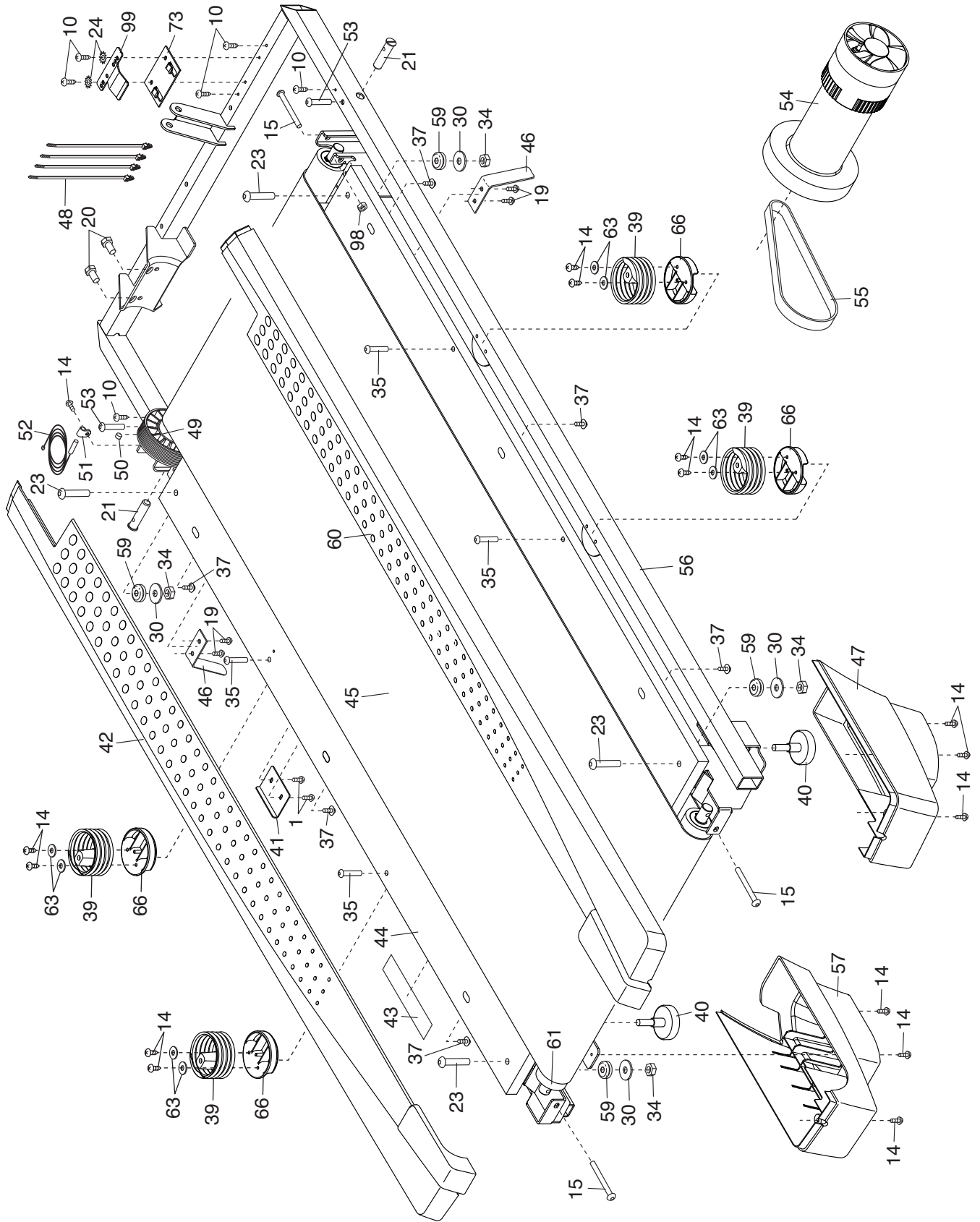

EXPLODED DRAWING B

Model No. PFTL59513.3 R1214A

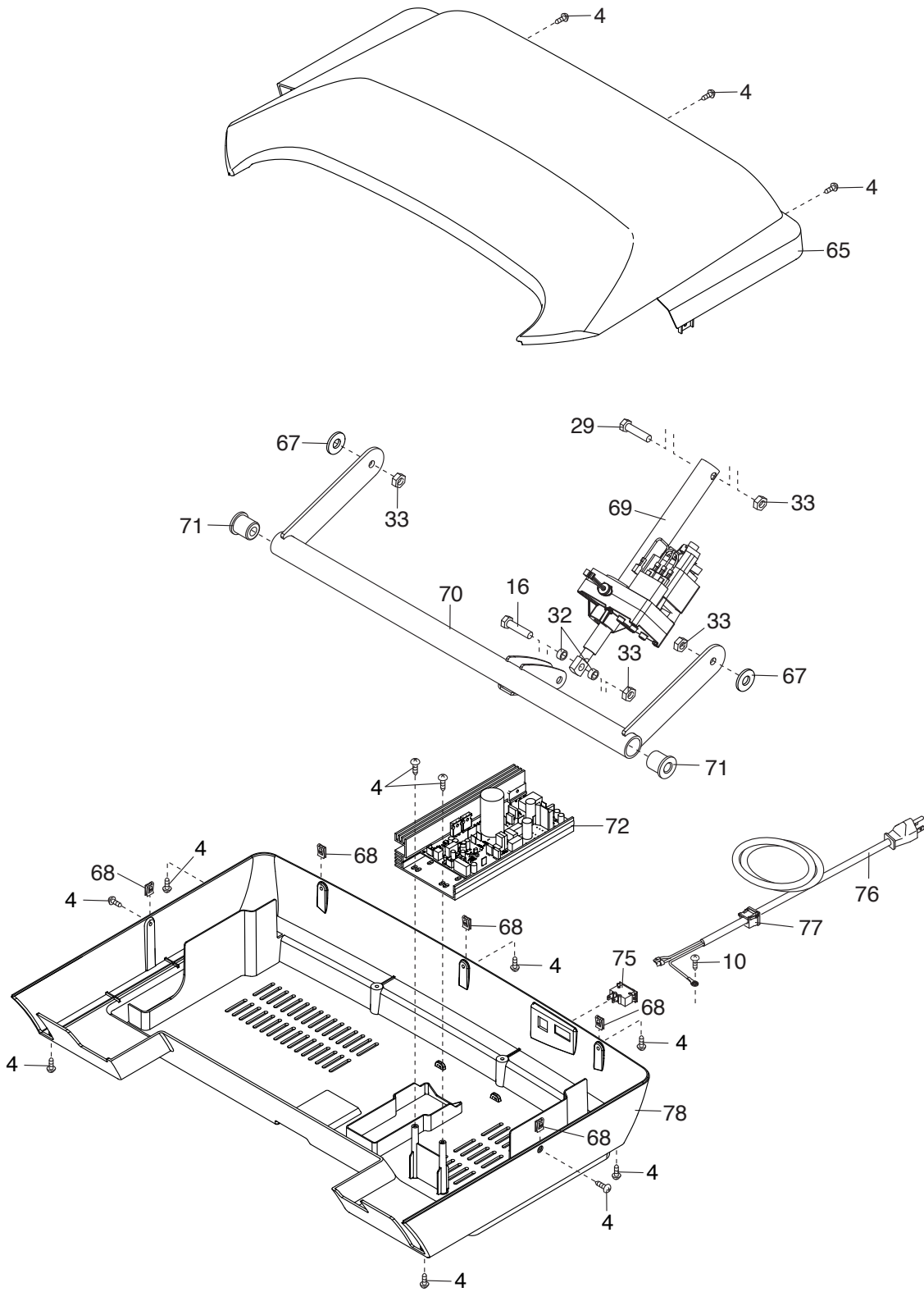

EXPLODED DRAWING C

Model No. PFTL59513.3 R1214A

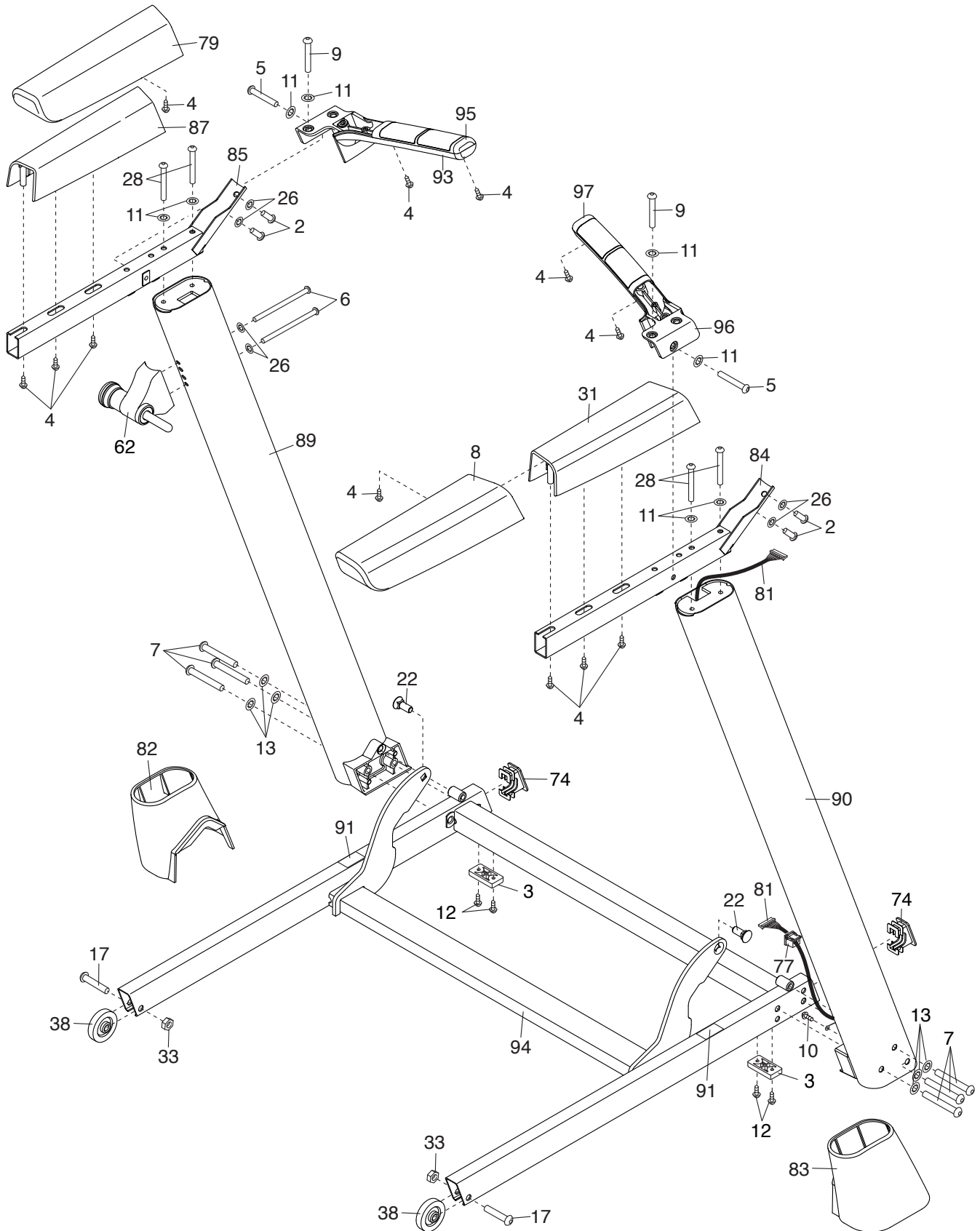

EXPLODED DRAWING D

Model No. PFTL59513.3 R1214A

