

EXPLODED DRAWING A

Model No. PFTL59515.5 R0918A

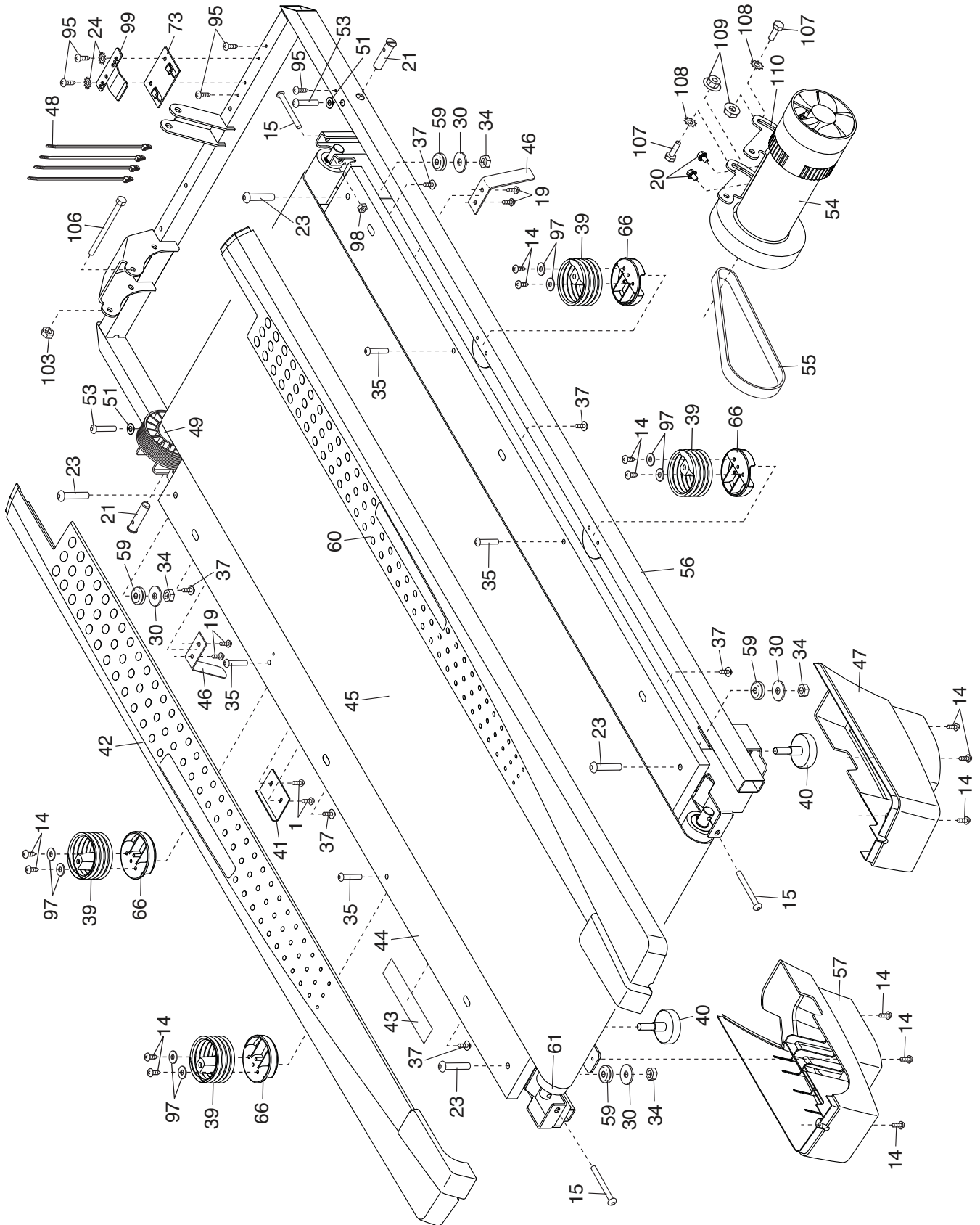

EXPLODED DRAWING B

Model No. PFTL59515.5 R0918A

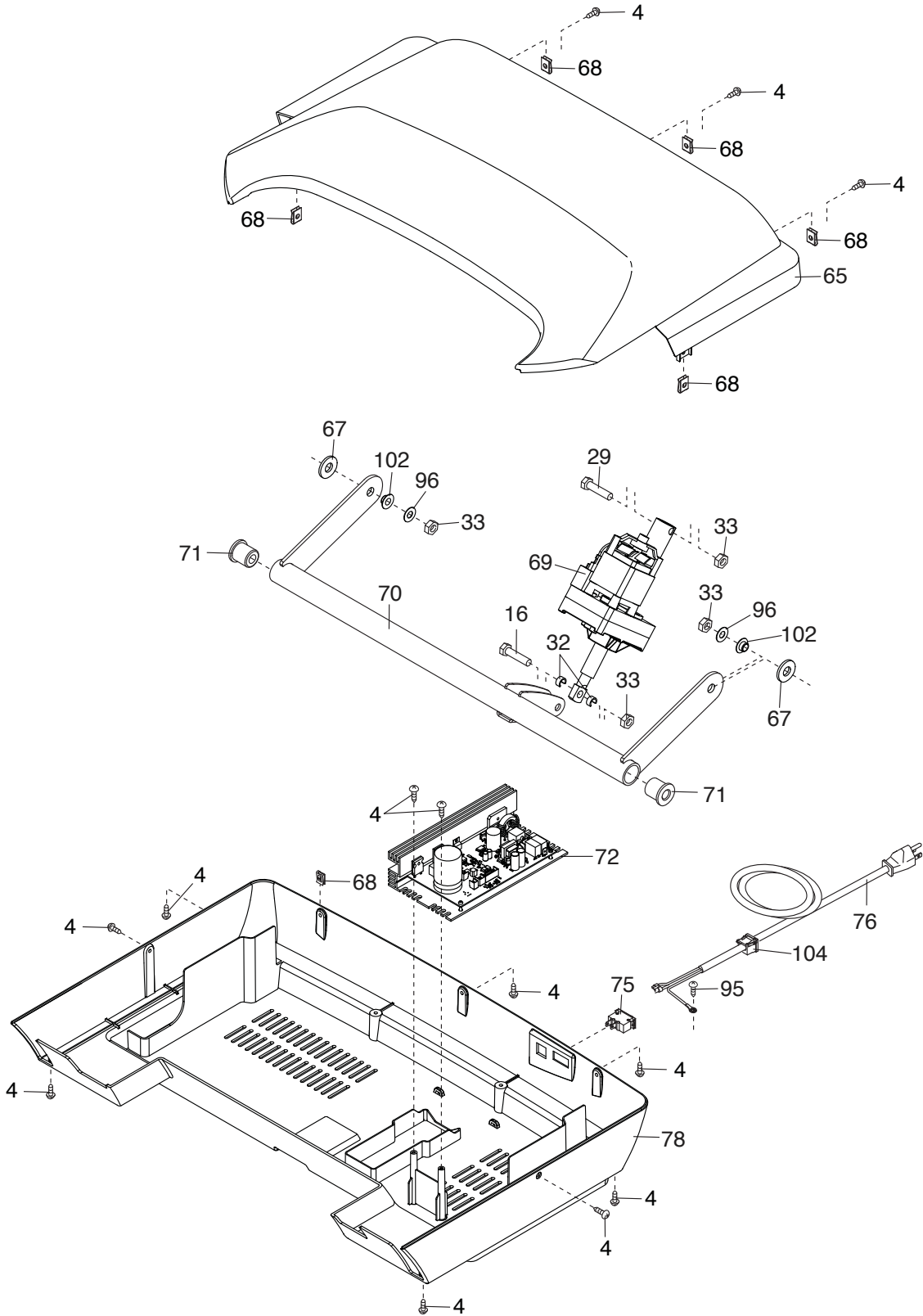

EXPLODED DRAWING D

Model No. PFTL59515.5 R0918A

