

EXPLODED DRAWING B

Model No. PFTL59614.0 R0514A

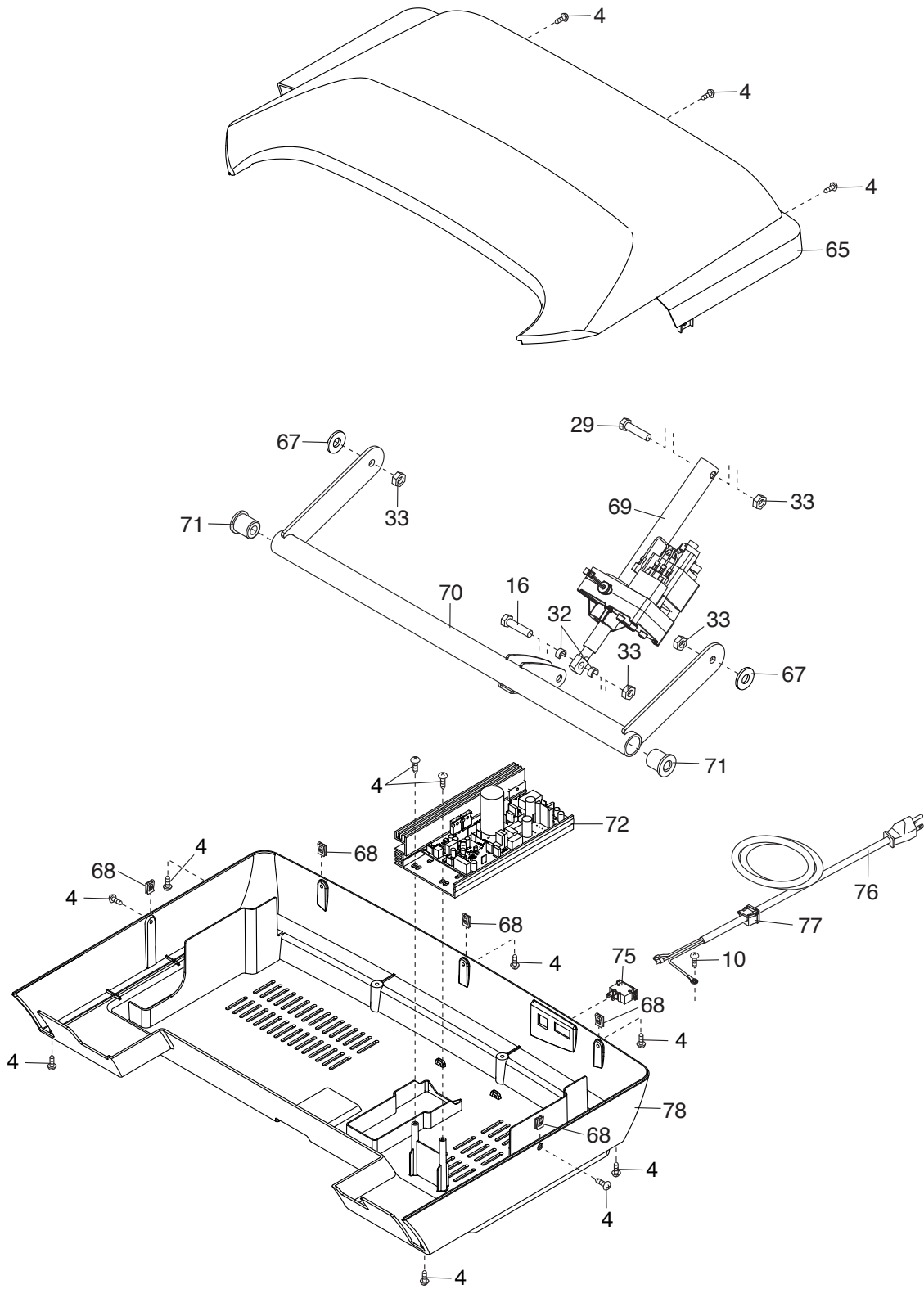

EXPLODED DRAWING C

Model No. PFTL59614.0 R0514A

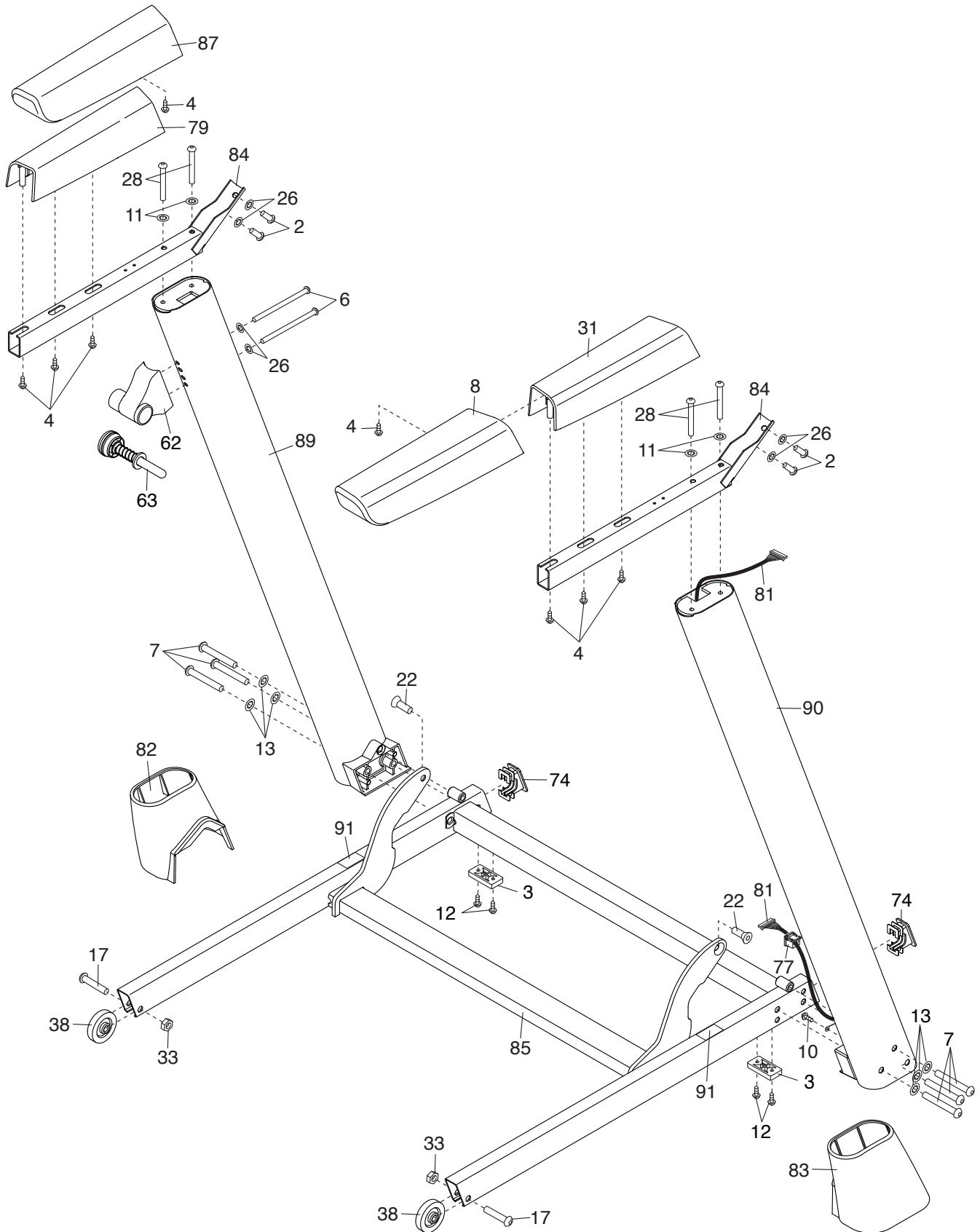

EXPLODED DRAWING D

Model No. PFTL59614.0 R0514A

