

# EXPLODED DRAWING A

Model No. PFTL59614.1 R0914A

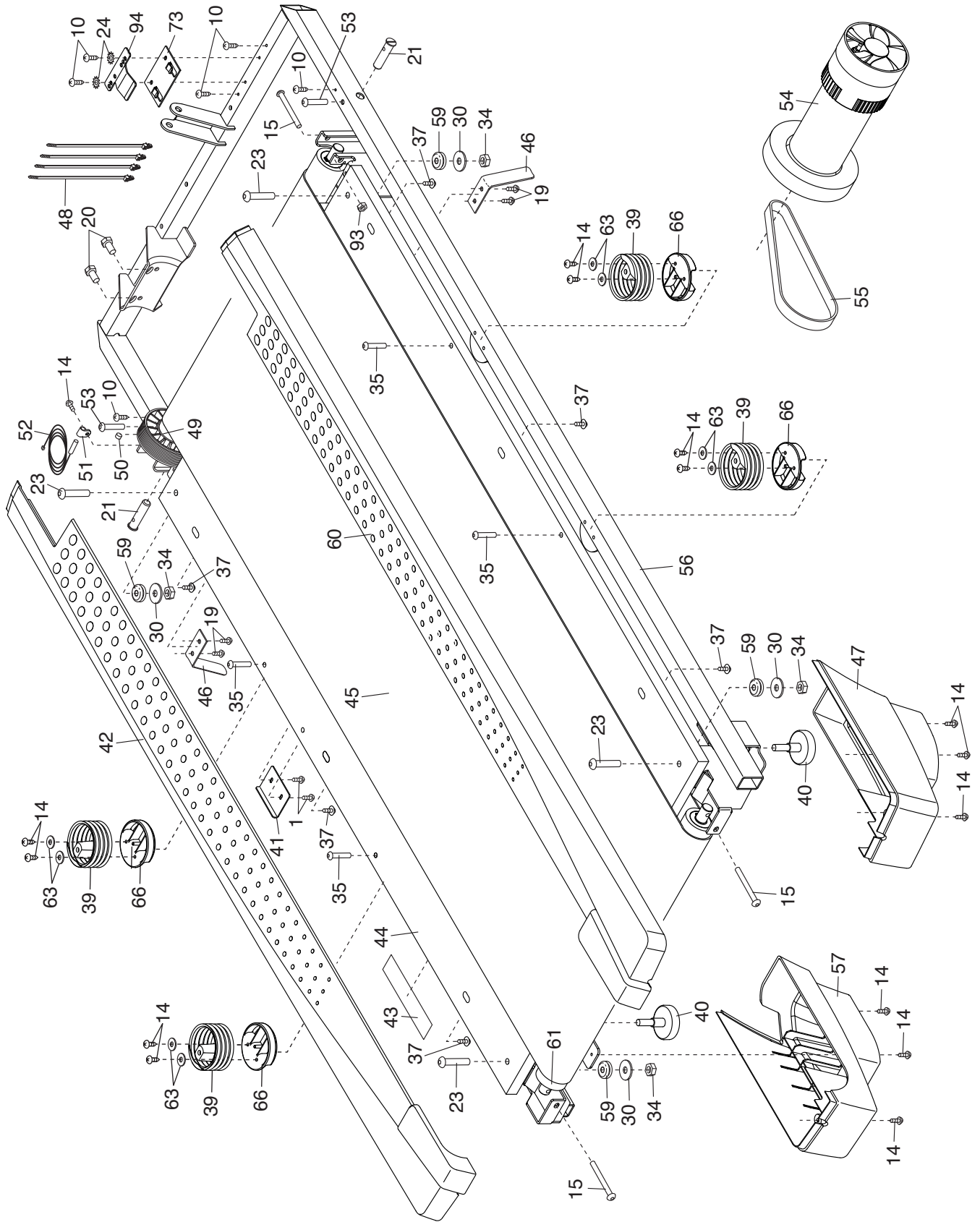

# EXPLODED DRAWING B

Model No. PFTL59614.1 R0914A

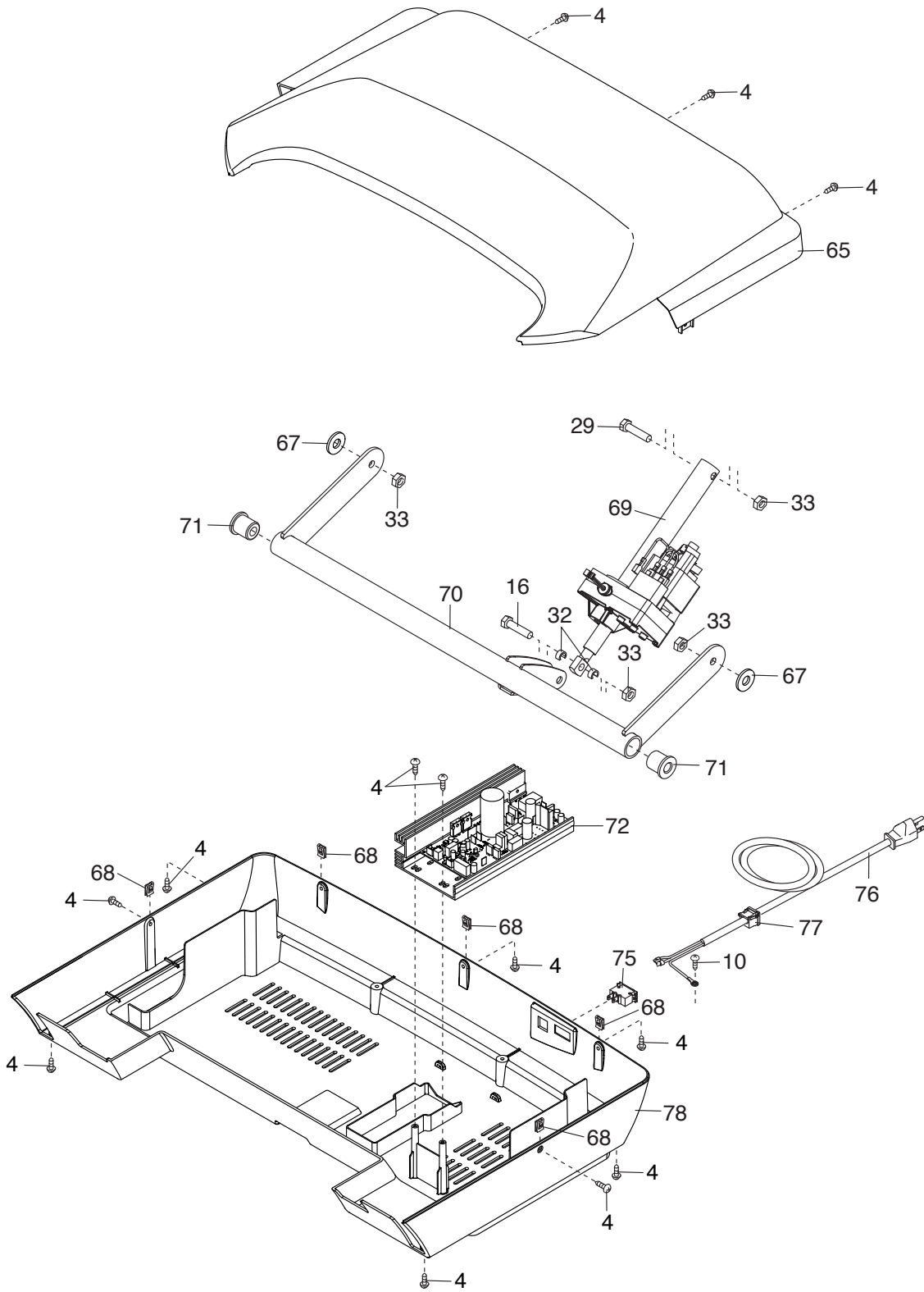

# EXPLODED DRAWING C

Model No. PFTL59614.1 R0914A

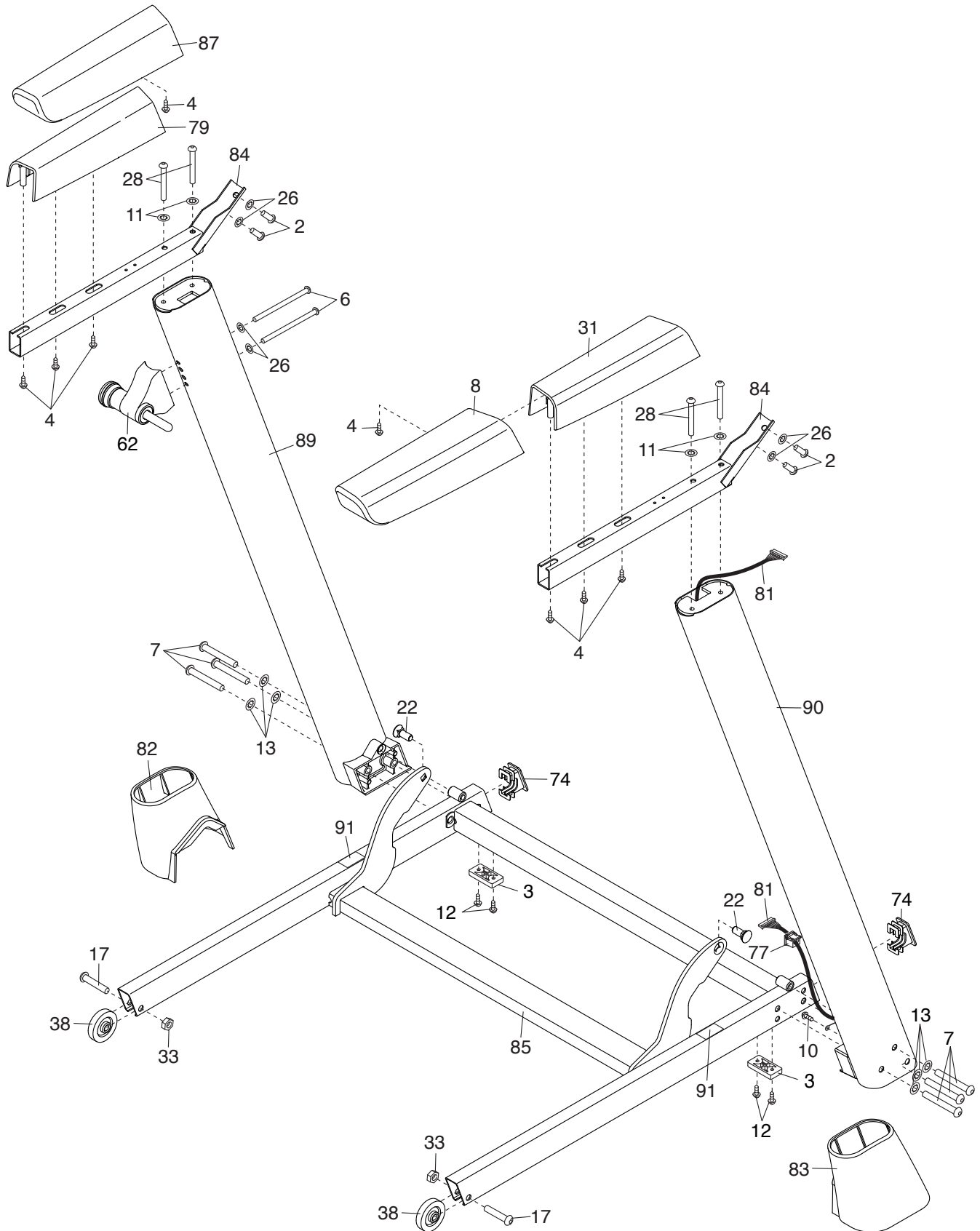

# EXPLODED DRAWING D

Model No. PFTL59614.1 R0914A

