

EXPLODED DRAWING A—Model No. PFTL59908.0

R1108A

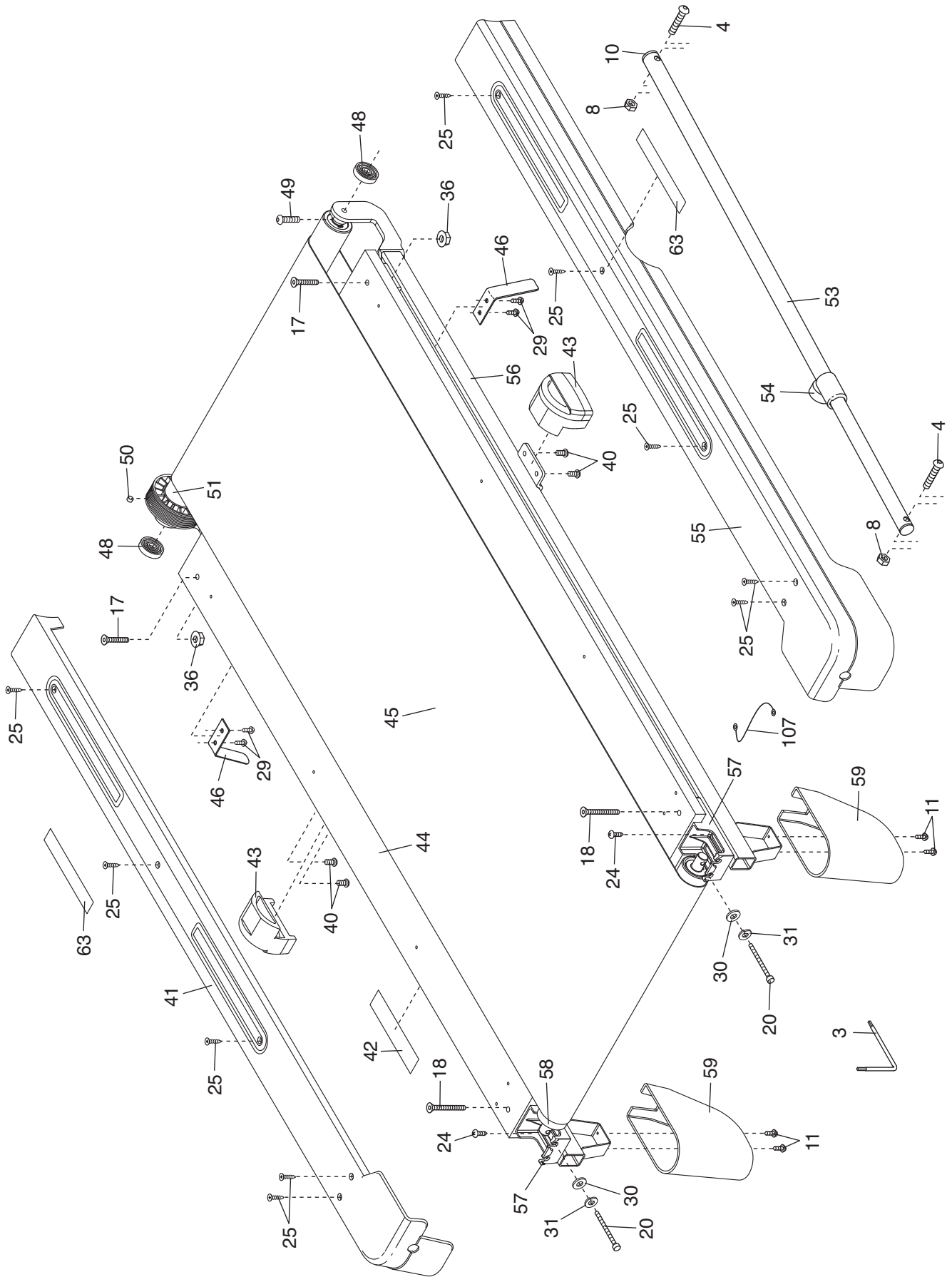

EXPLODED DRAWING B—Model No. PFTL59908.0

R1108A

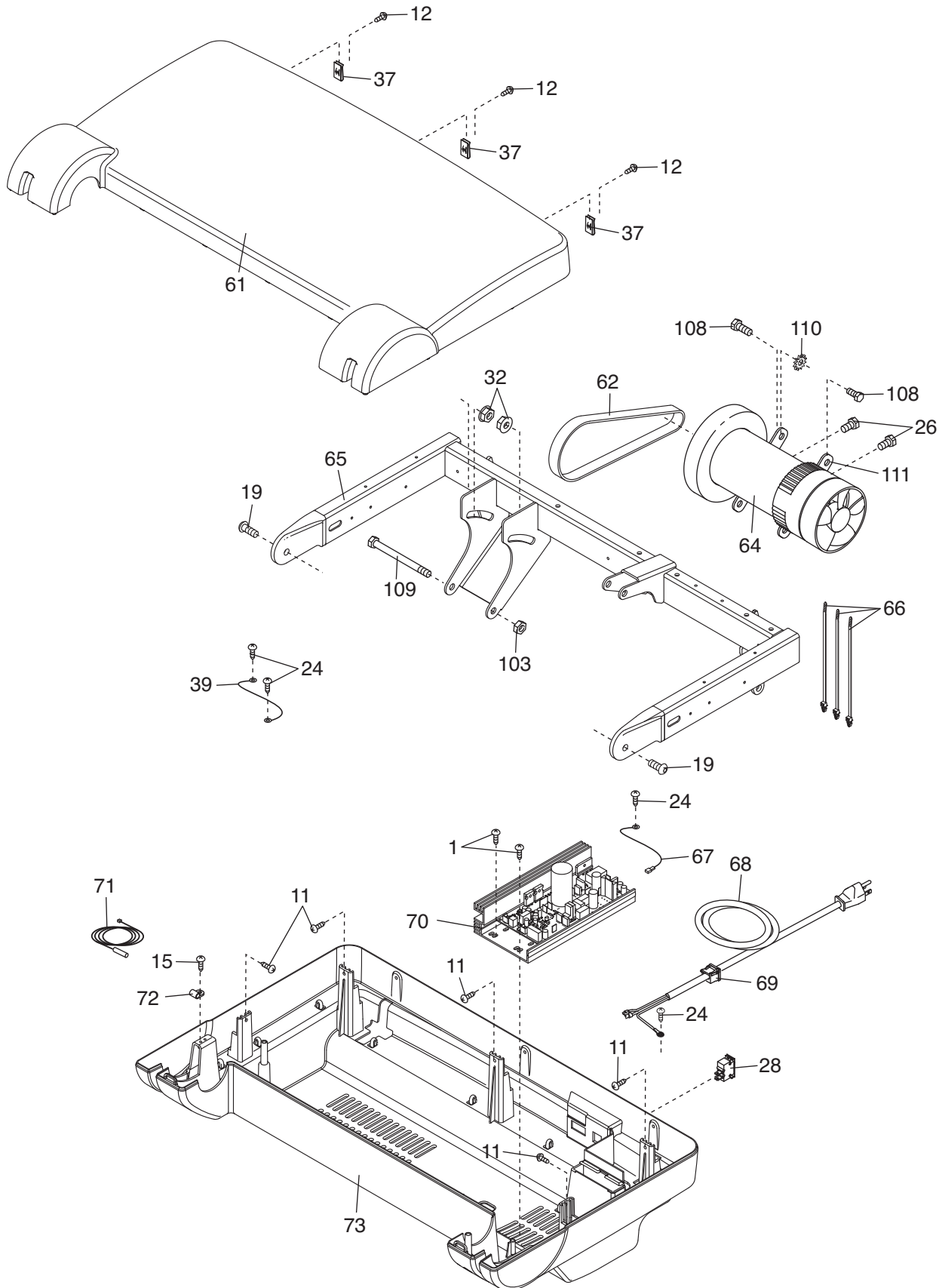

EXPLODED DRAWING C—Model No. PFTL59908.0

R1108A

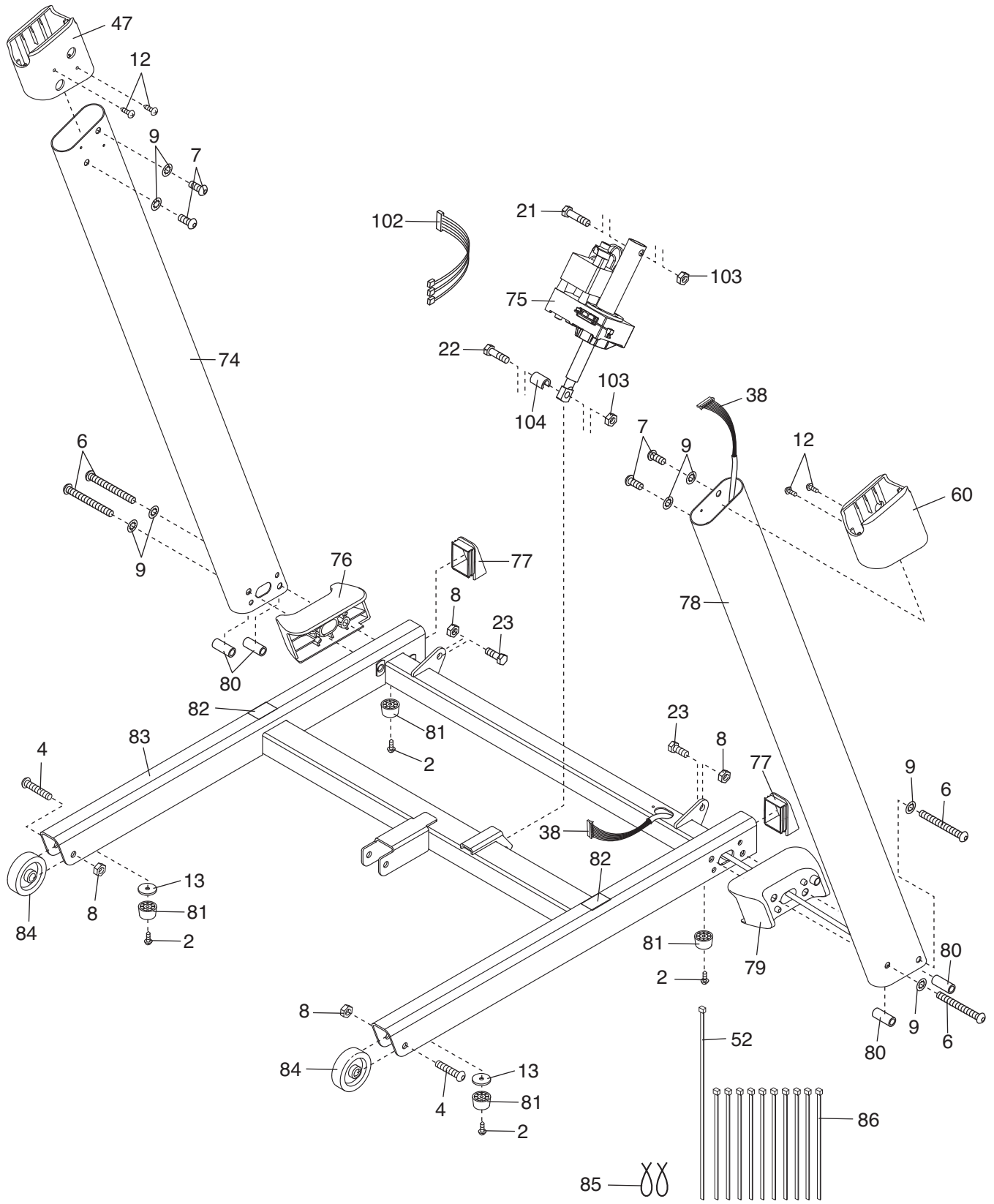

EXPLODED DRAWING D—Model No. PFTL59908.0

R1108A

