

EXPLODED DRAWING A

Model No. PFTL60009.2 R0311A

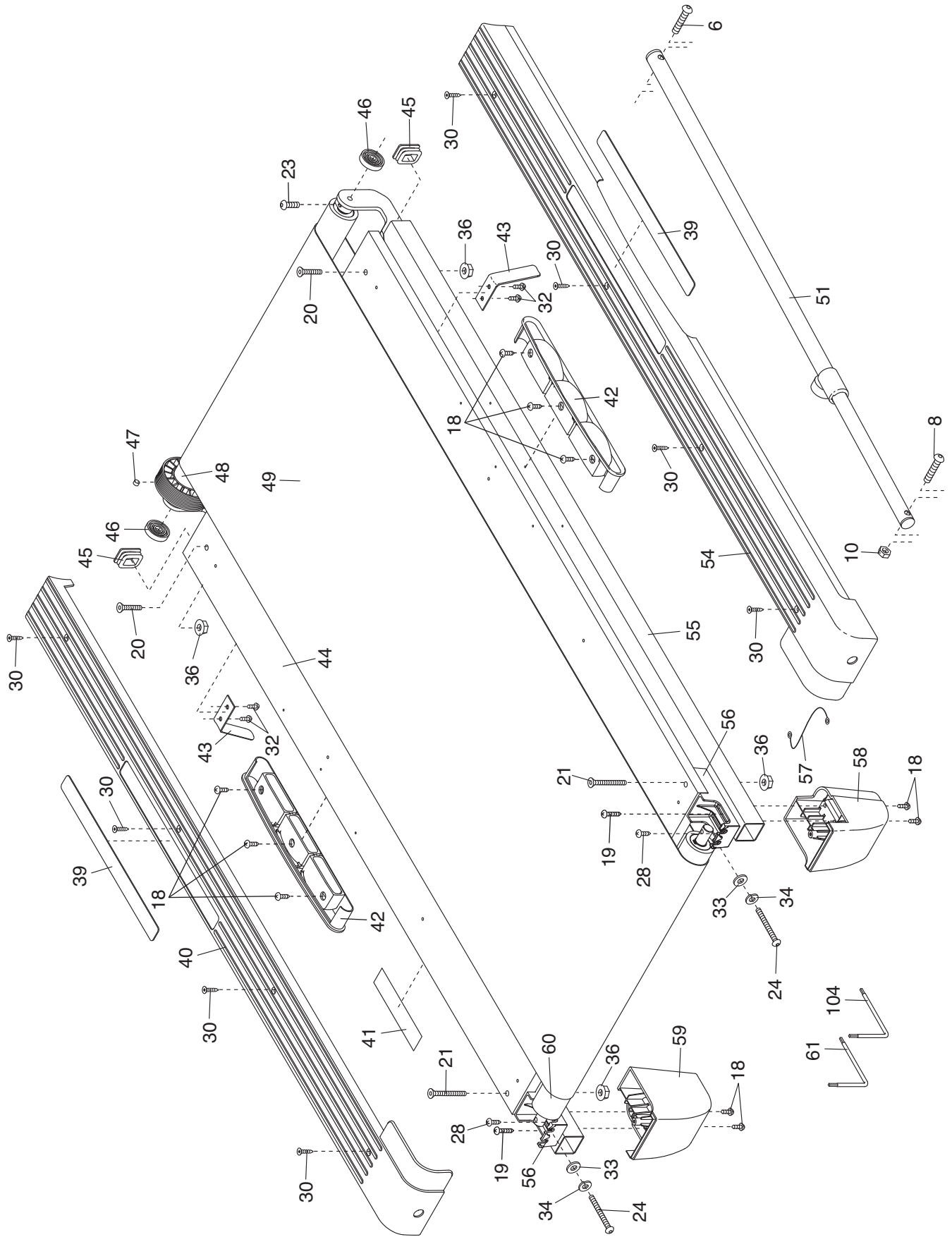

EXPLODED DRAWING B

Model No. PFTL60009.2 R0311A

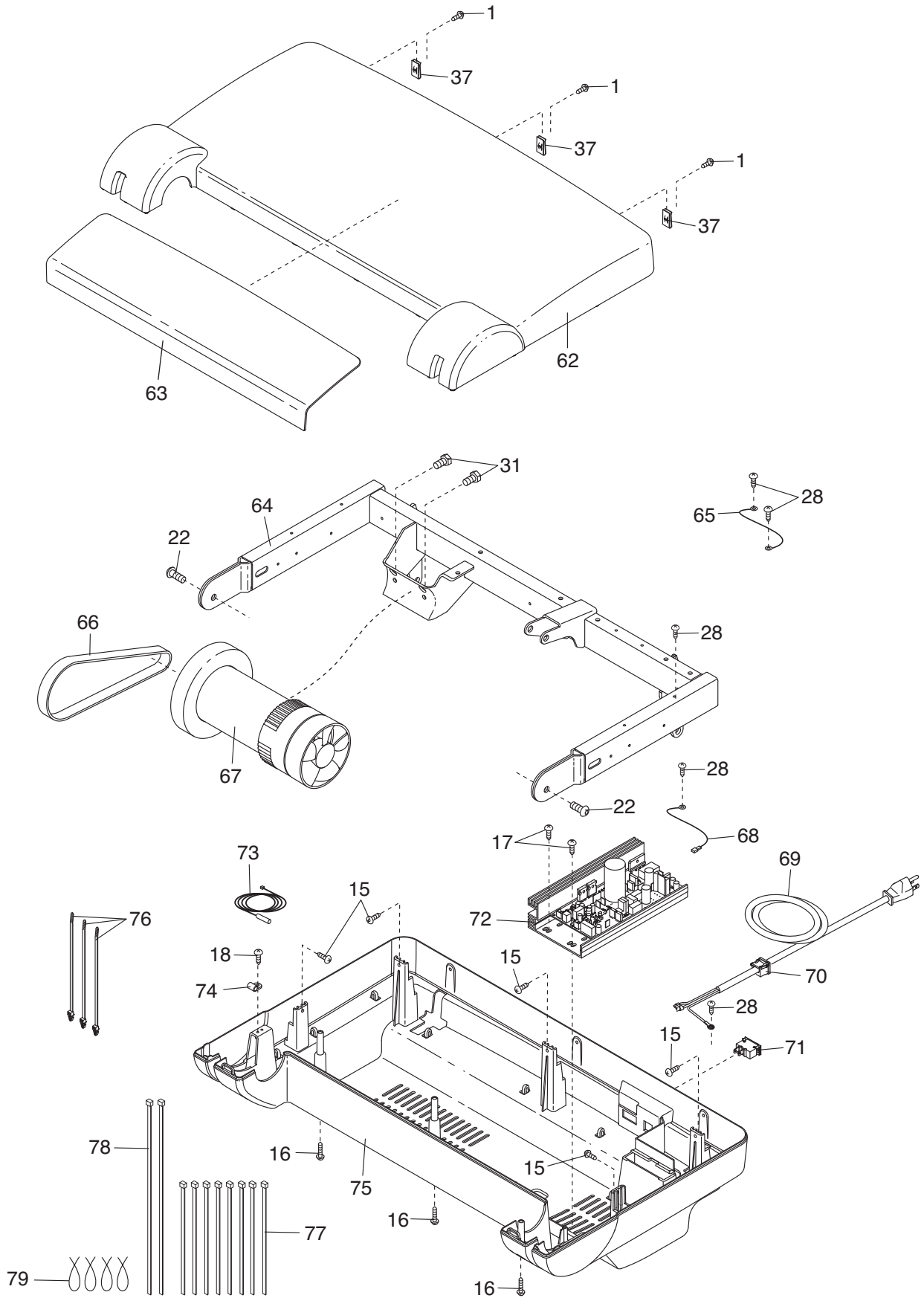

EXPLODED DRAWING C

Model No. PFTL60009.2 R0311A

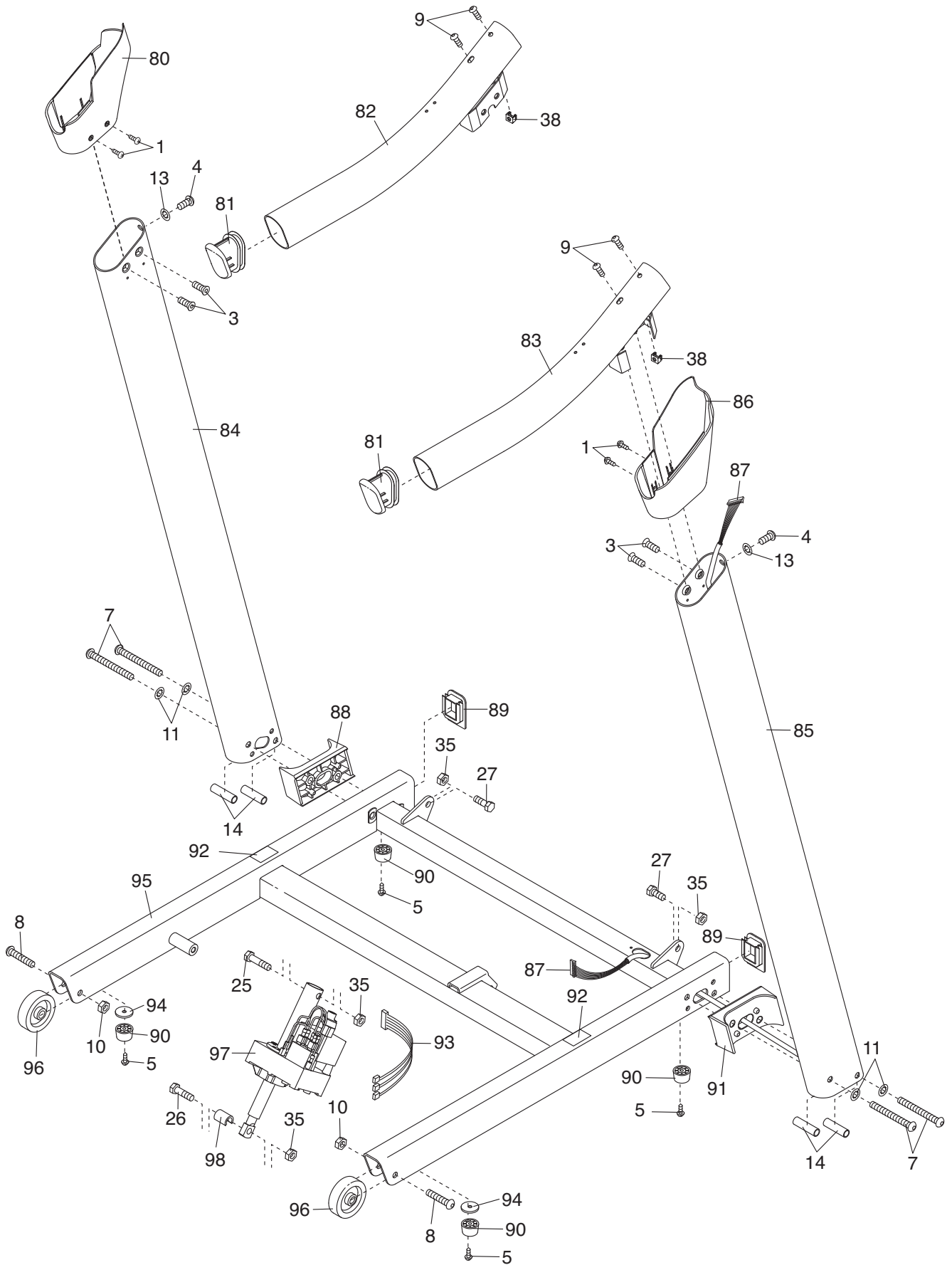

EXPLODED DRAWING D

Model No. PFTL60009.2 R0311A

