

# EXPLODED DRAWING A—Model No. PFTL60509.0

R0111A

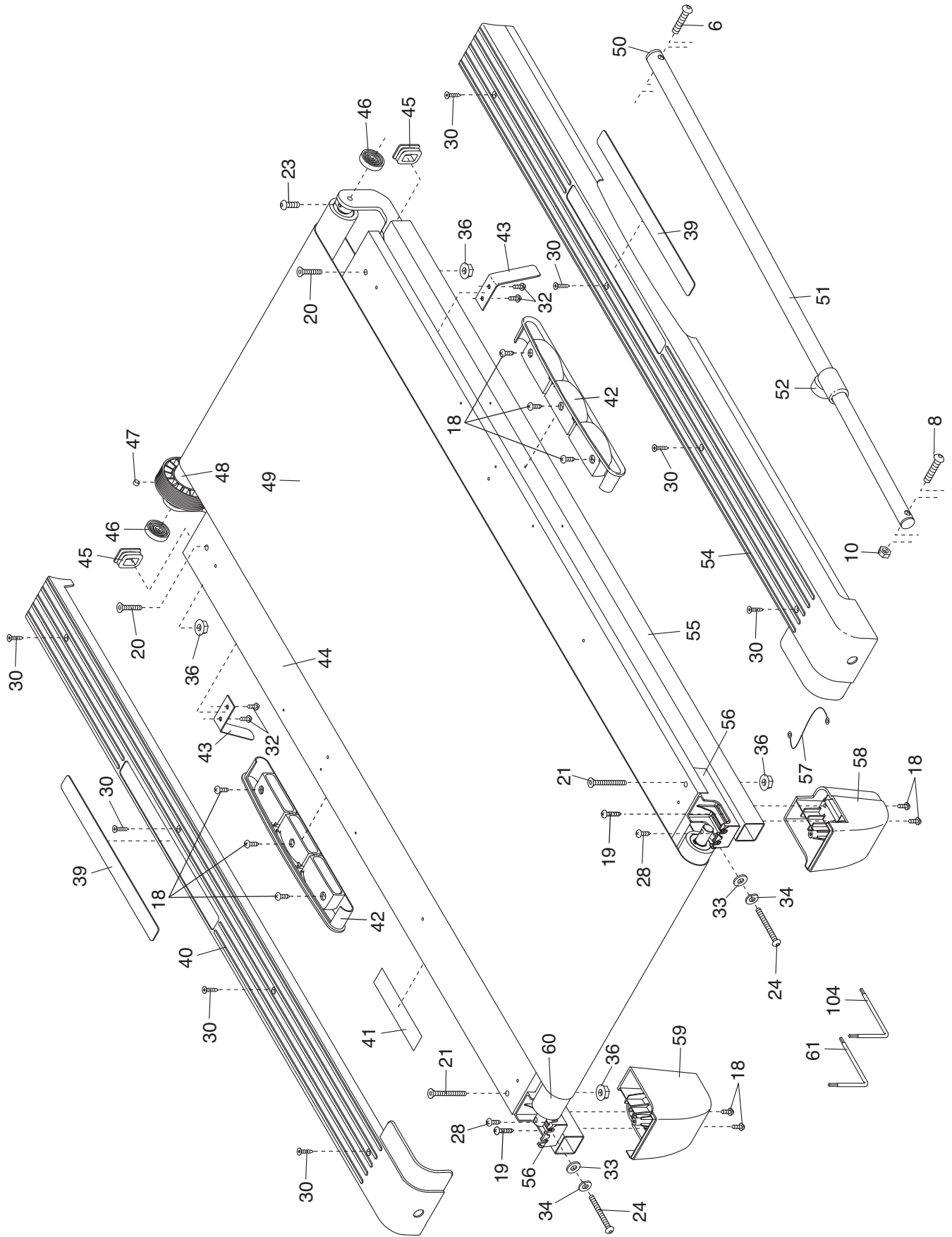

# EXPLODED DRAWING B—Model No. PFTL60509.0

R0111A

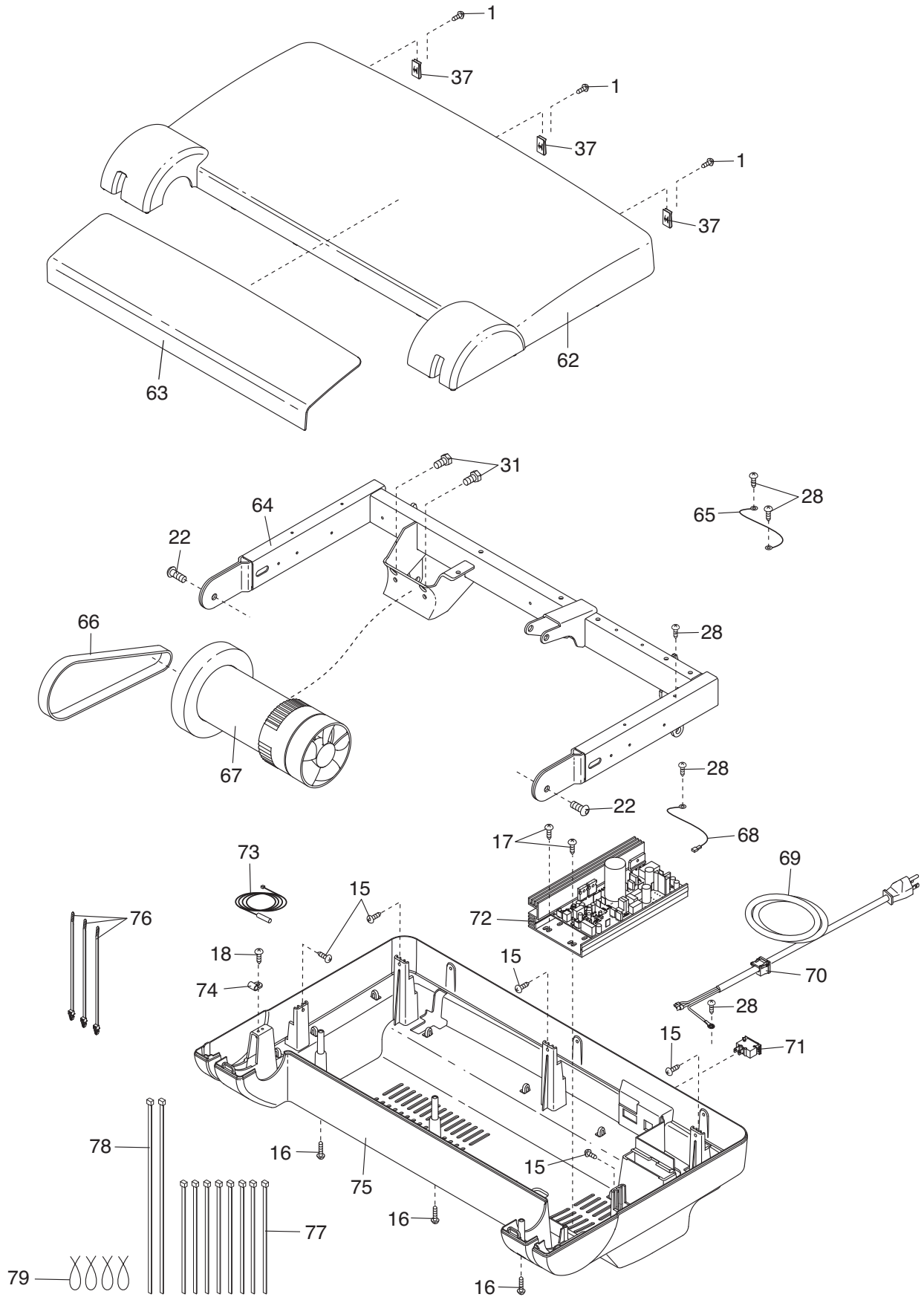

# EXPLODED DRAWING C—Model No. PFTL60509.0

R0111A

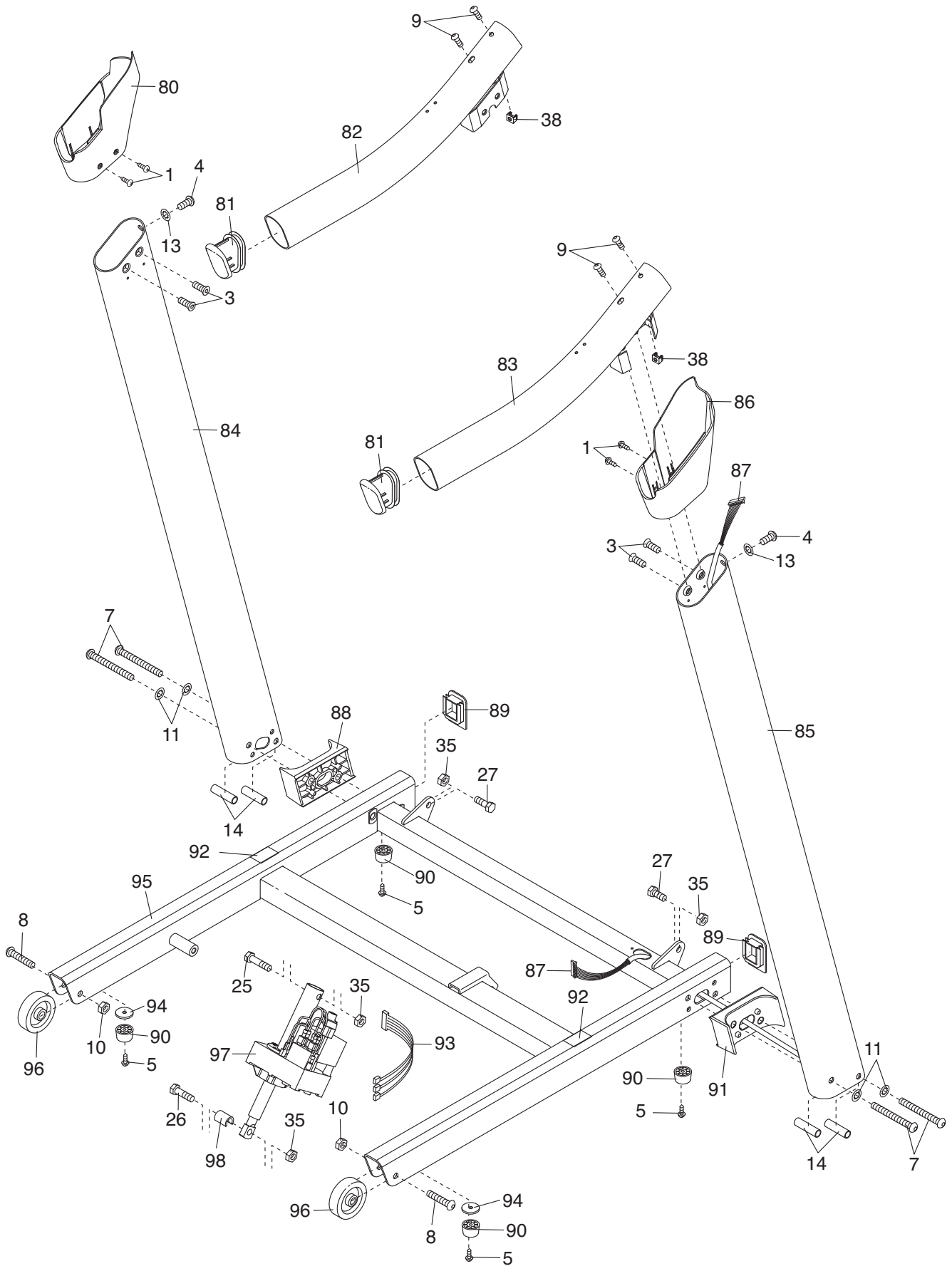

# EXPLODED DRAWING D—Model No. PFTL60509.0

R0111A

