

EXPLODED DRAWING A—Model No. PFTL60910.0

R0312A

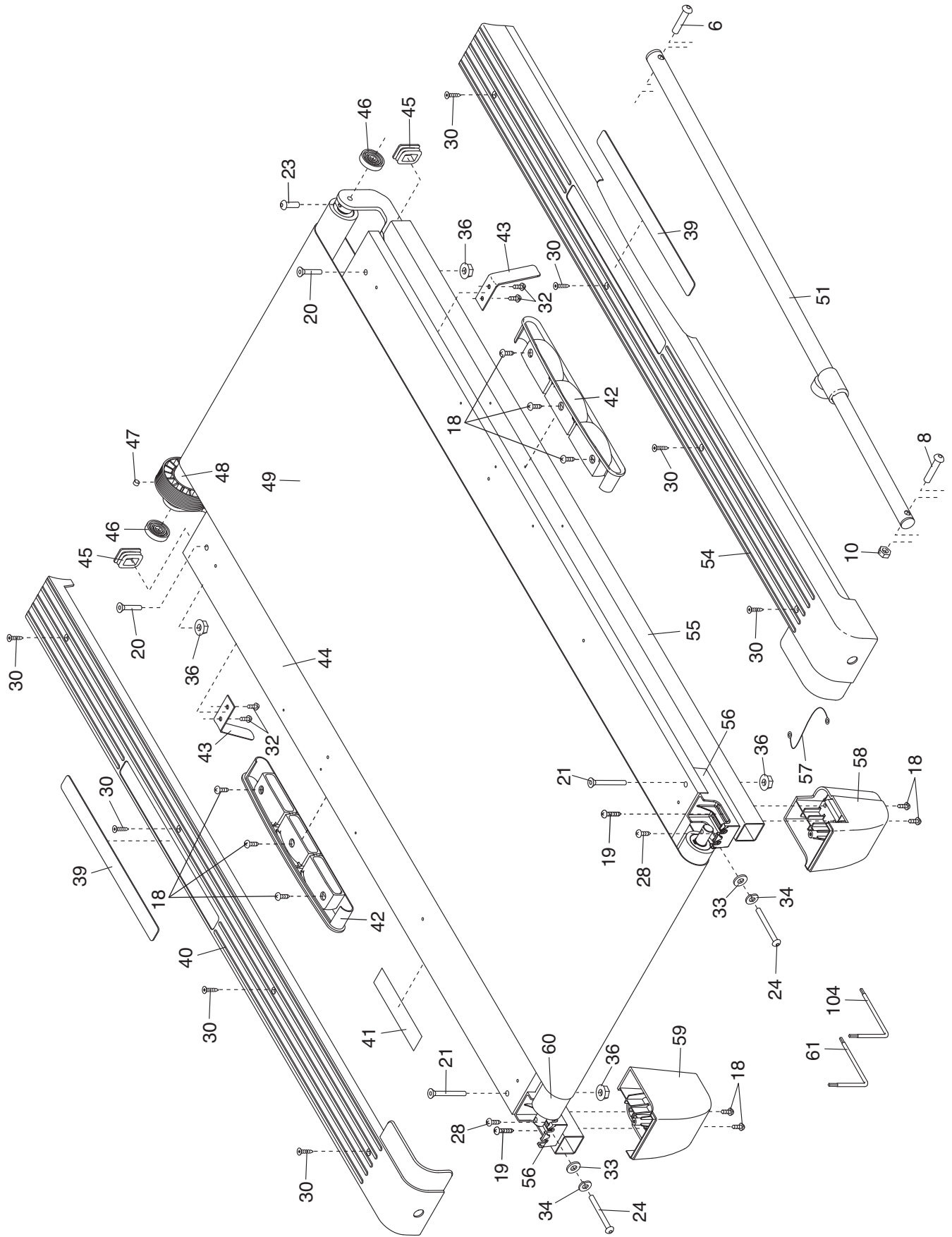

EXPLODED DRAWING B—Model No. PFTL60910.0

R0312A

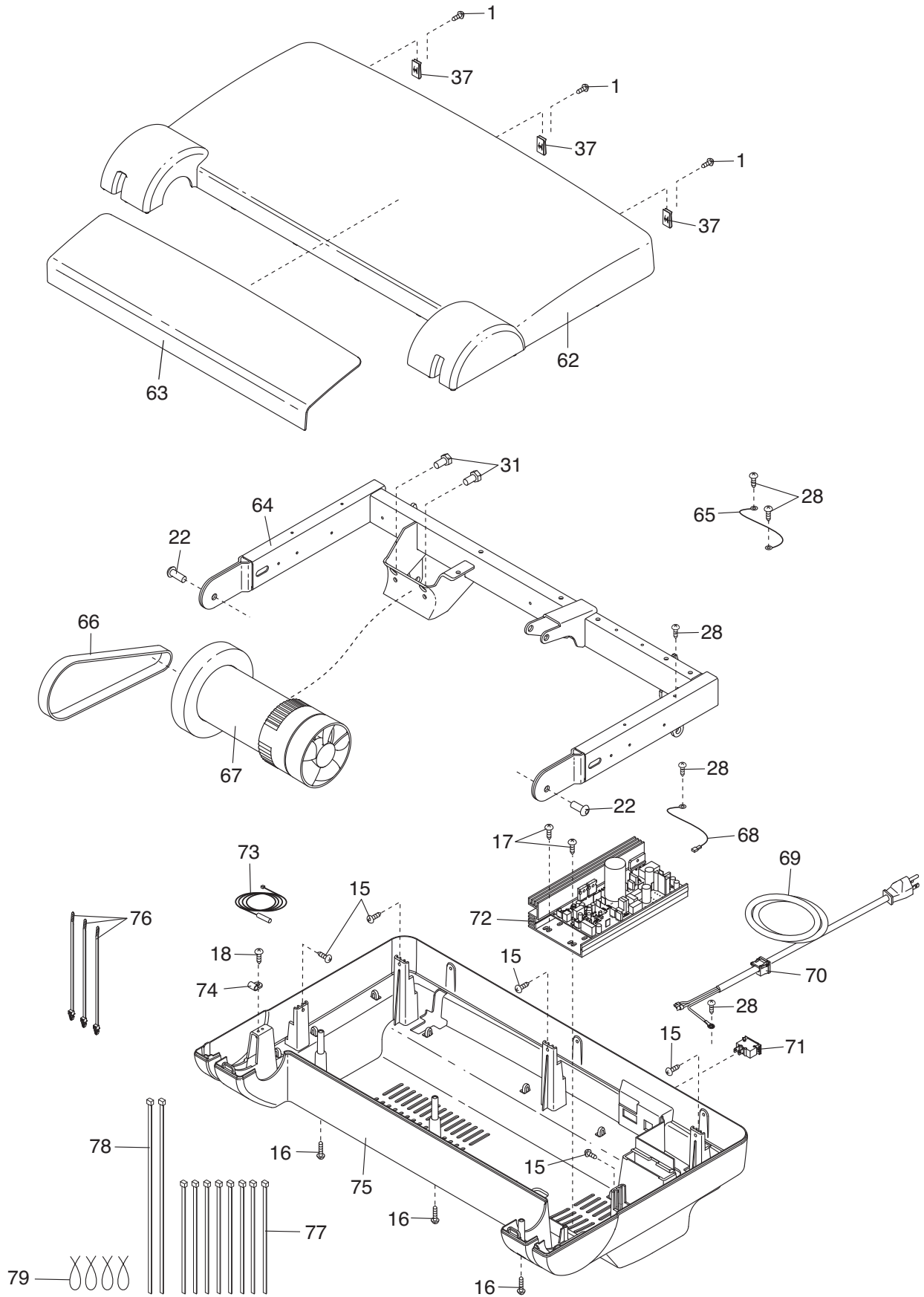

EXPLODED DRAWING C—Model No. PFTL60910.0

R0312A

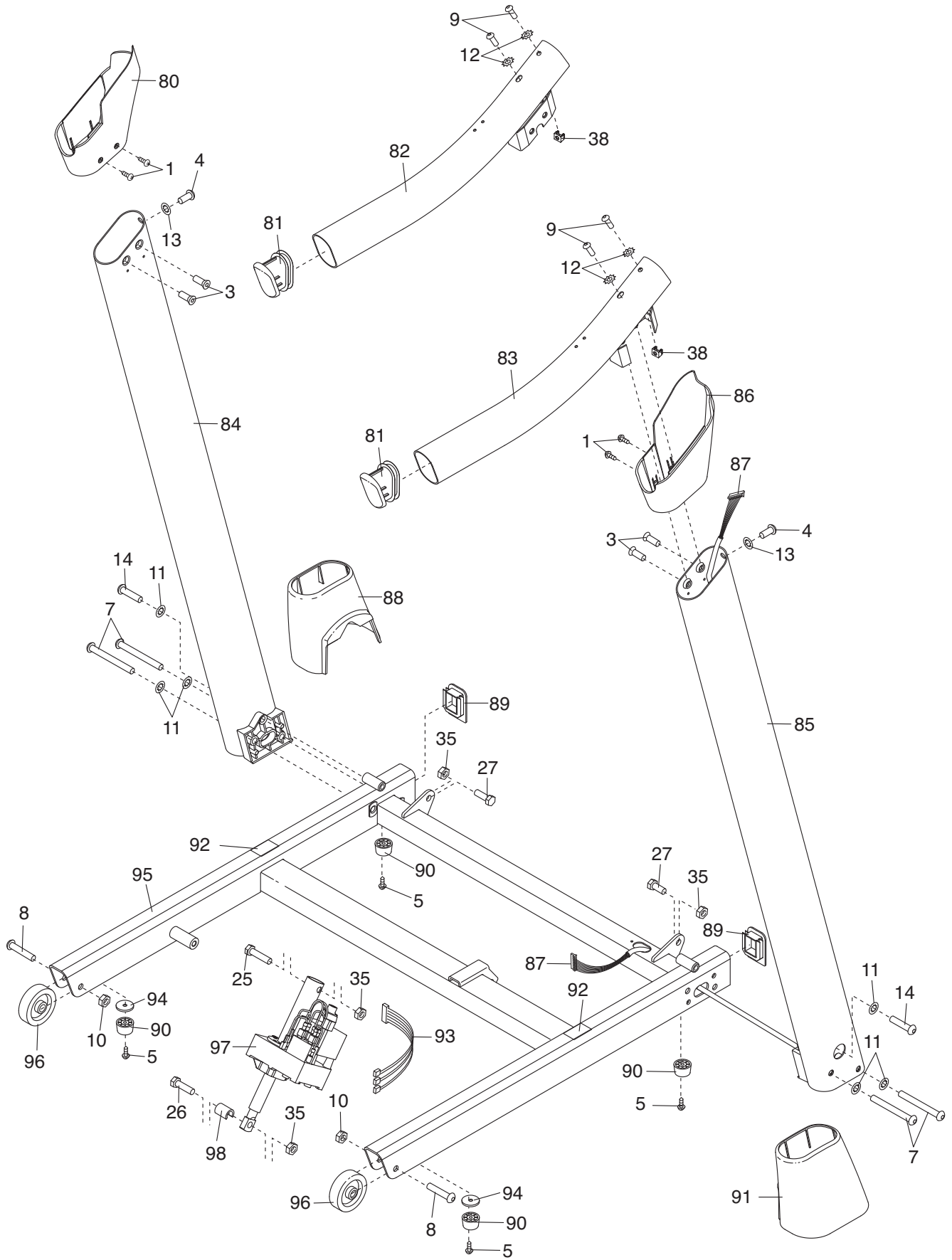

EXPLODED DRAWING D—Model No. PFTL60910.0

R0312A

