

EXPLODED DRAWING A—Model No. PFTL60910.1

R0910A

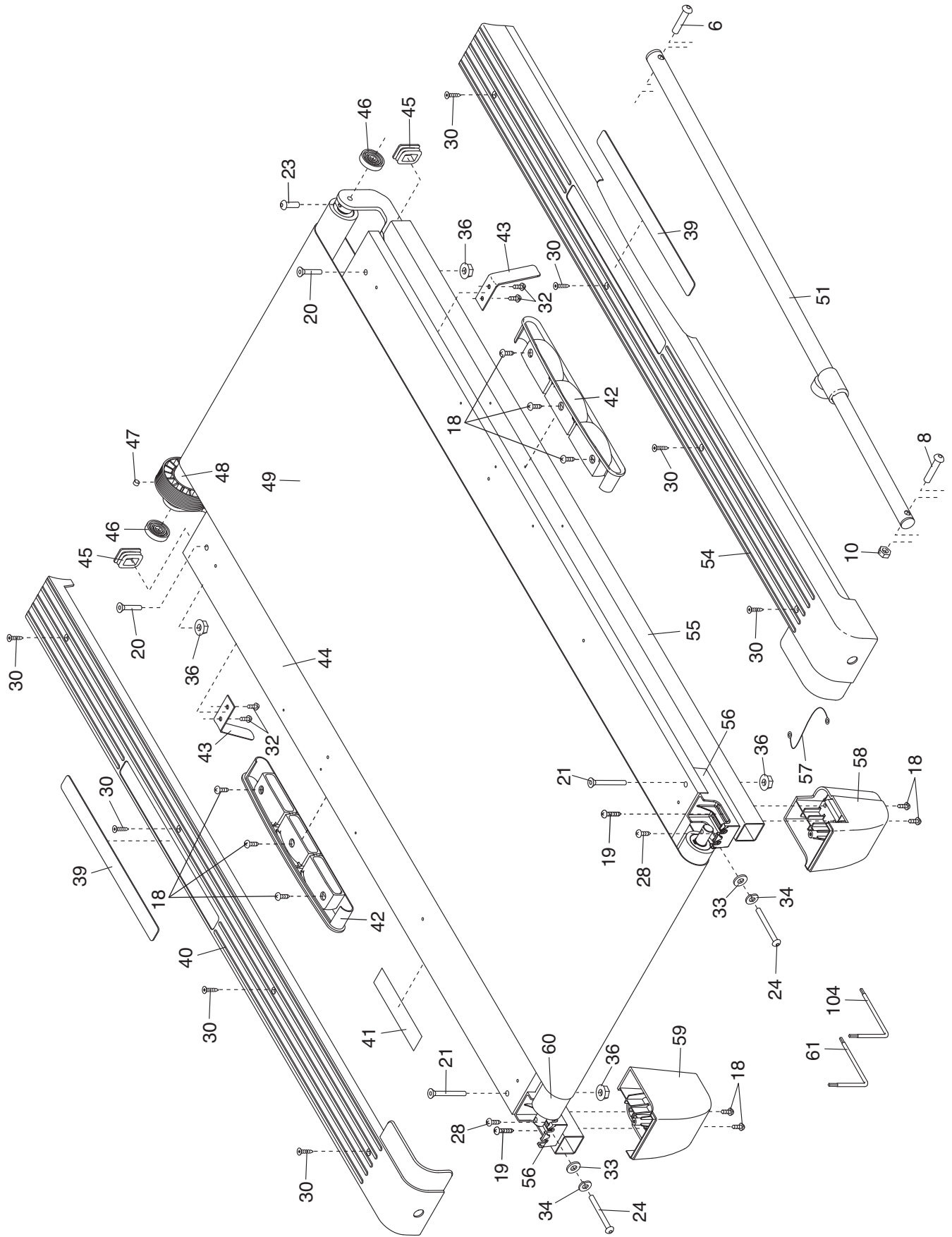

EXPLODED DRAWING B—Model No. PFTL60910.1

R0910A

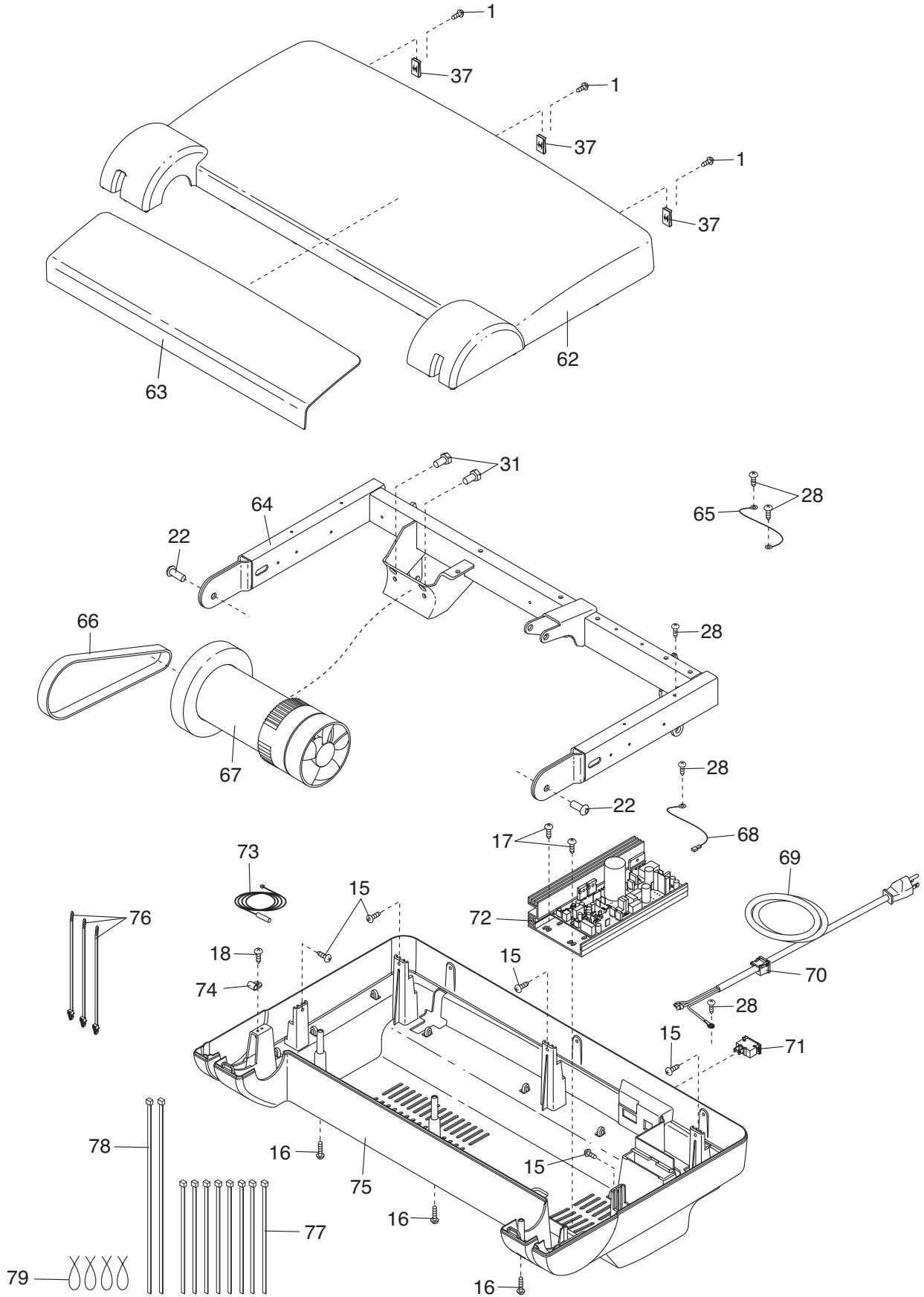

EXPLODED DRAWING D—Model No. PFTL60910.1

R0910A

