

EXPLODED DRAWING B

Model No. PFTL60913.0 R1113A

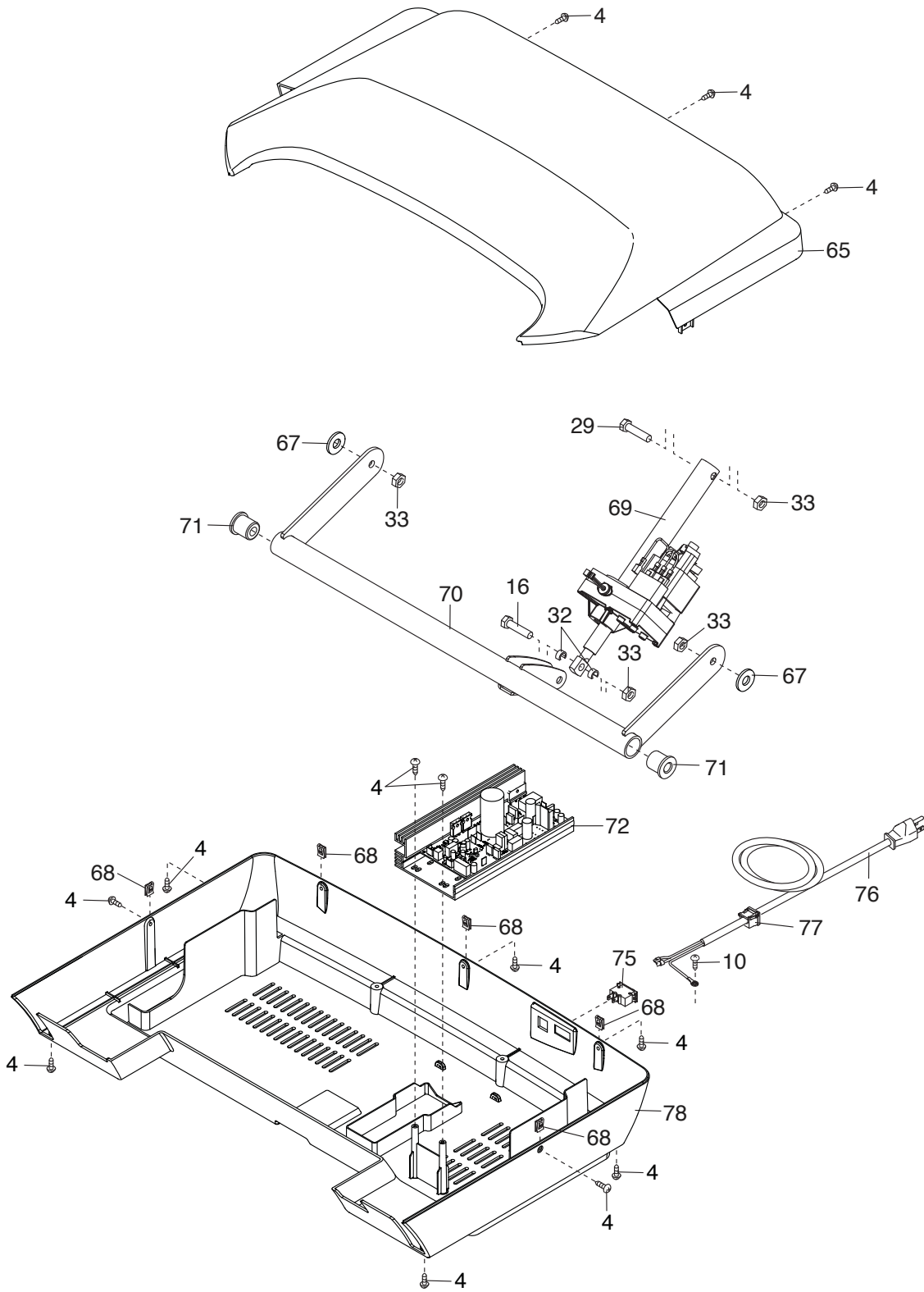

EXPLODED DRAWING C

Model No. PFTL60913.0 R1113A

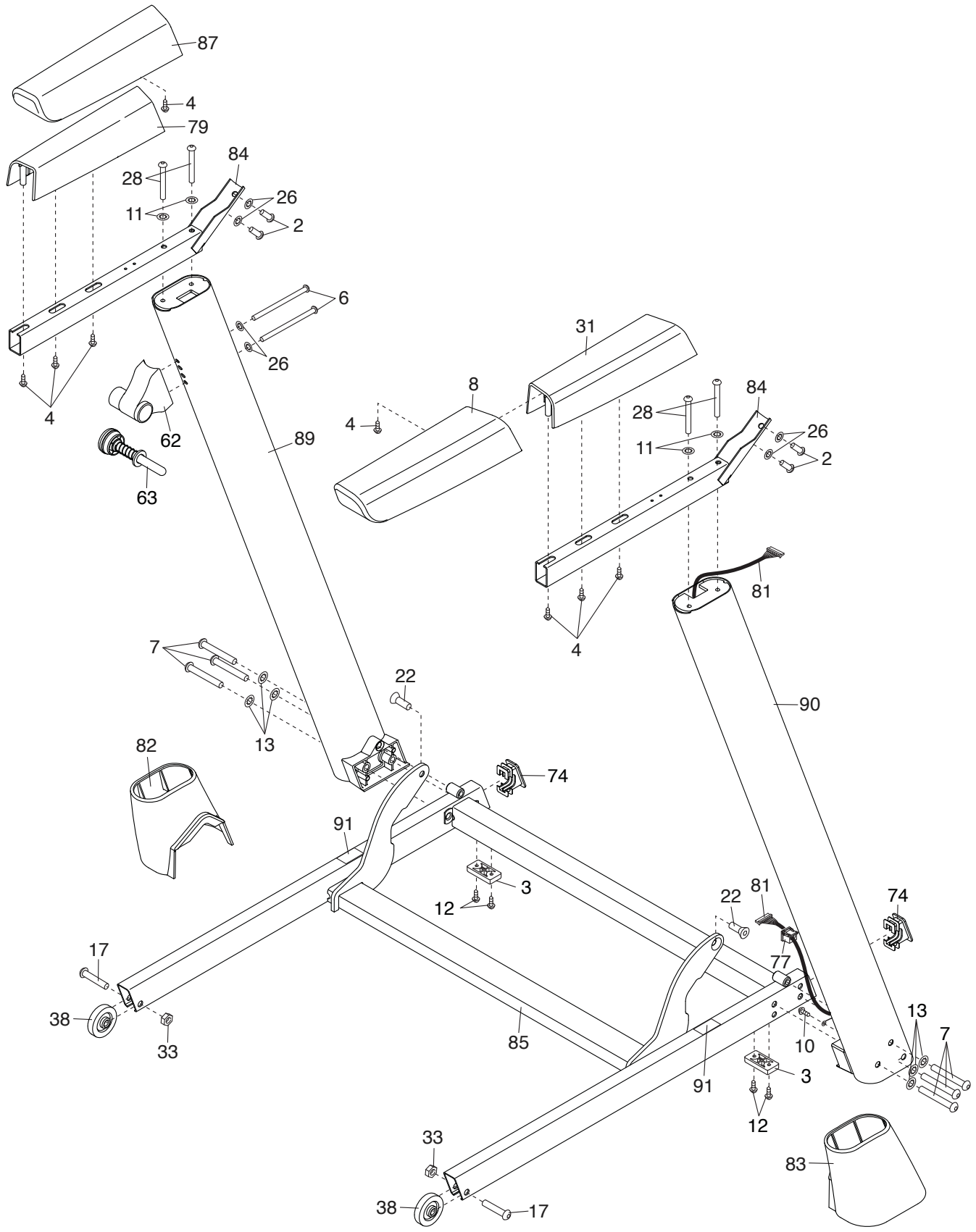

EXPLODED DRAWING D

Model No. PFTL60913.0 R1113A

