

# EXPLODED DRAWING A

Model No. PFTL60916.5 R0818A

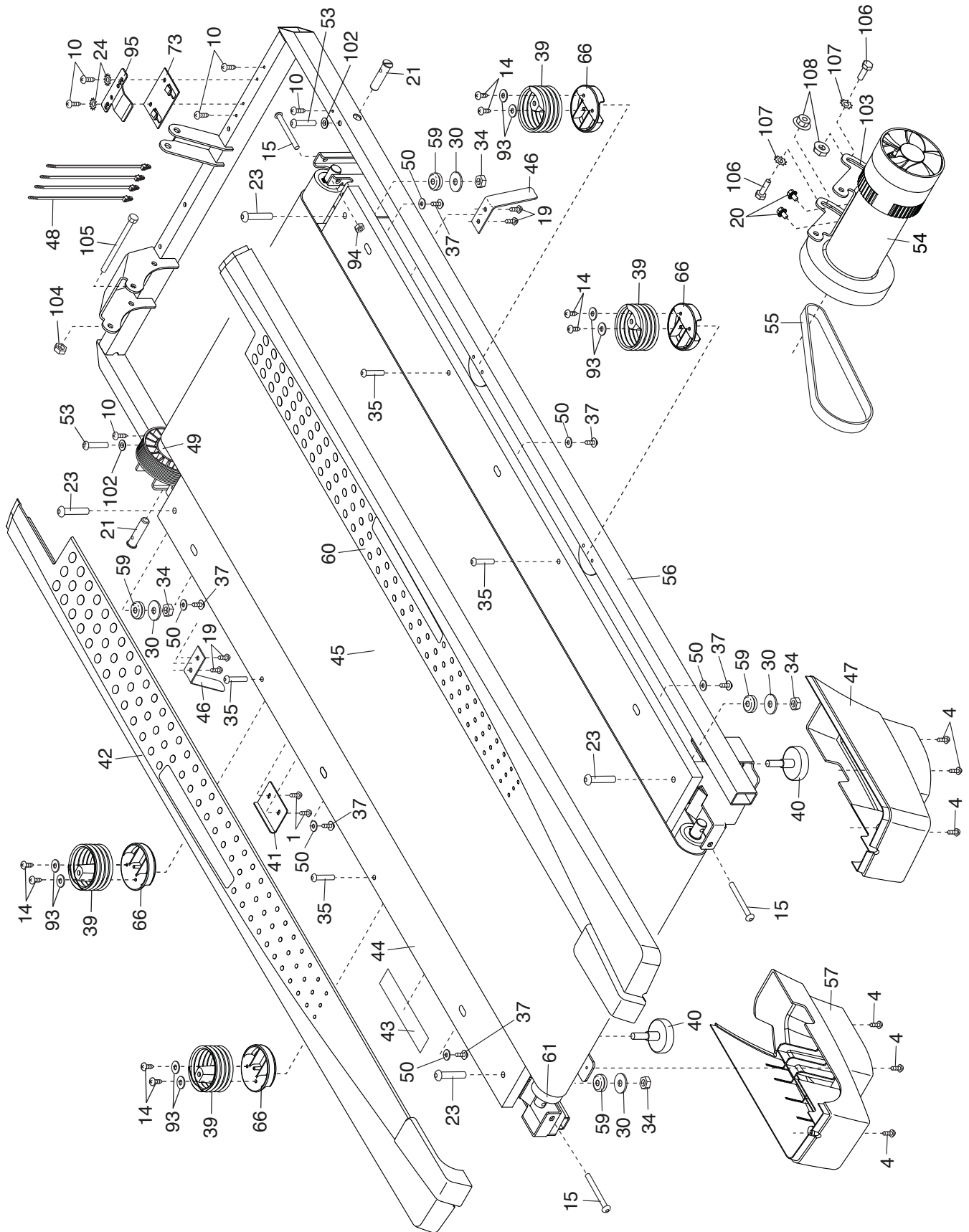

# EXPLODED DRAWING B

Model No. PFTL60916.5 R0818A

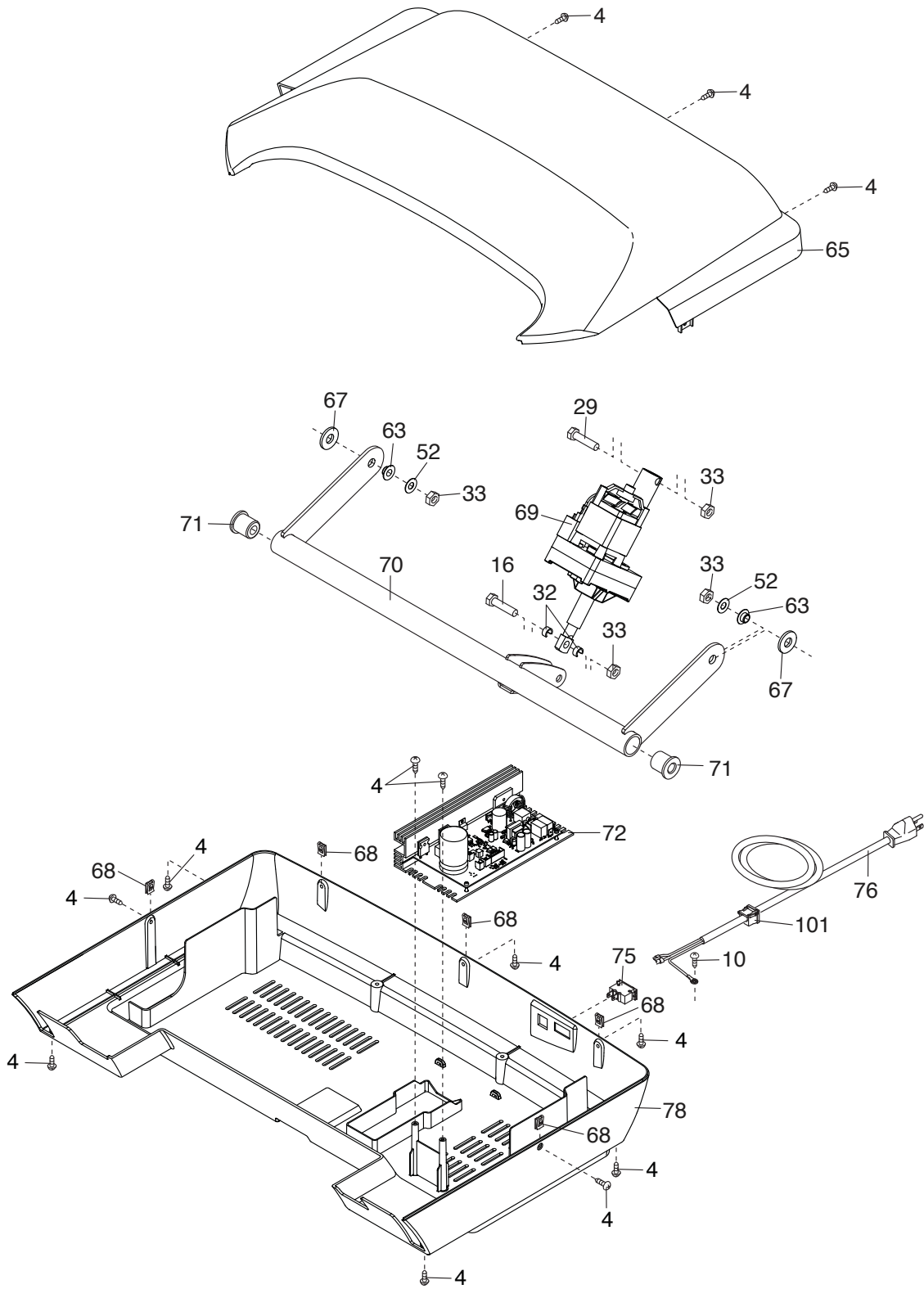

# EXPLODED DRAWING C

Model No. PFTL60916.5 R0818A

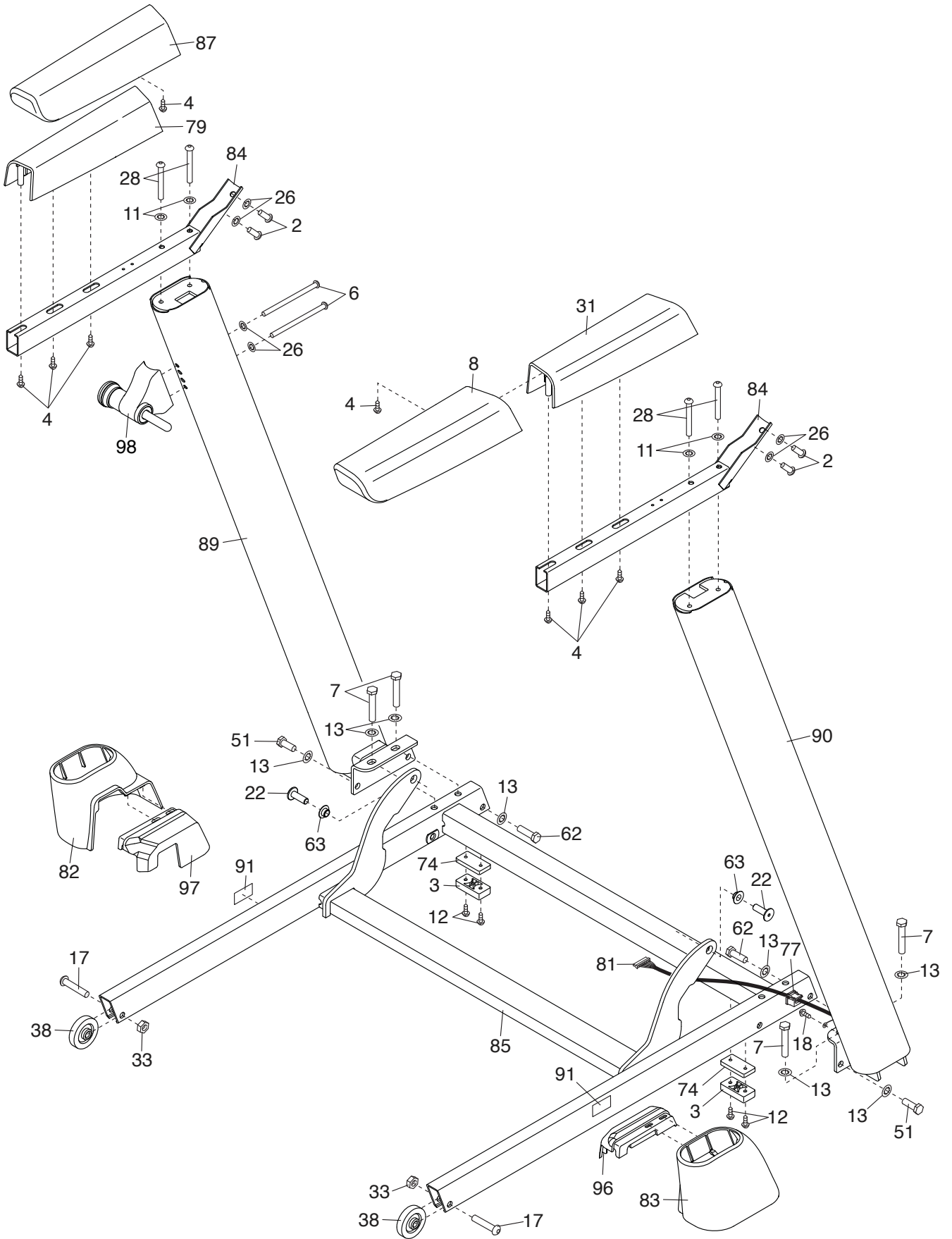

# EXPLODED DRAWING D

Model No. PFTL60916.5 R0818A

